

MI945X

Intel® Core™ 2 Duo/GM45
Mini-ITX Motherboard

USER'S MANUAL

Version 1.0A

Acknowledgments

Award is a registered trademark of Award Software International, Inc.

PS/2 is a trademark of International Business Machines Corporation.

Intel and Intel® Core 2 Duo and Intel® Celeron processors are registered trademarks of Intel Corporation.

Microsoft Windows is a registered trademark of Microsoft Corporation.

Winbond is a registered trademark of Winbond Electronics Corporation.

All other product names or trademarks are properties of their respective owners.

Table of Contents

Introduction	1
Product Description.....	1
Checklist.....	2
MI945X Specifications	3
Board Dimensions	4
Installations	7
Installing the CPU	8
Installing the Memory	9
Setting the Jumpers	10
Connectors on MI945X.....	14
BIOS Setup.....	24
Drivers Installation	46
Intel Chipset Software Installation Utility.....	47
VGA Drivers Installation	49
High Definition Codec Audio Driver Installation.....	51
LAN Drivers Installation.....	52
Appendix	54
A. I/O Port Address Map.....	54
B. Interrupt Request Lines (IRQ).....	55
C. Watchdog Timer Configuration.....	56

IMPORTANT NOTE: When the system boots without the CRT being connected, there will be no image on screen when you insert the CRT/VGA cable. To show the image on screen, the hotkey must be pressed (CTRL-ALT-F1).



MI945X Mini ITX Motherboard

Introduction

Product Description

The MI945X Mini ITX board incorporates the Mobile Intel® GM45 Express Chipset for Embedded Computing, consisting of the Intel® GM45 Graphic Memory Controller Hub (GMCH) and Intel® I/O Controller Hub (ICH9-M), an optimized integrated graphics solution with a 1066MHz and 800MHz front-side bus. Dimensions of the board are 170mm x 170mm.

The integrated powerful 3D graphics engine, based on Intel® Graphics Media Accelerator X3500 (Intel® GMA X3500) architecture, operates at core speeds of up to 533 MHz. It features a low-power design, is validated with the Intel® Core 2 Duo processors on 45nm process. With dual channel DDR3 800/1066MHz two SODIMM sockets on board, the board supports up to 4GB of system memory.

Intel® Graphics supports a unique intelligent memory management scheme called Dynamic Video Memory Technology (DVMT). DVMT handles diverse applications by providing the maximum (384MB) availability of system memory for general computer usage, while supplying additional graphics memory when a 3D-intensive application requests it. The Intel GMA X3500 graphics architecture also takes advantage of the high-performance Intel processor. Intel GMA X3500 graphics supports Dual Independent Display technology.

The main features of the board are:

- Supports Intel® Mobile Core 2 Duo/Core 2 Quad Processor (Penryn)
- Supports up to 2.93GHz, 1066MHz/800MHz FSB
- Two DDR3 SoDIMM, Max. 4GB memory
- Onboard Gigabit PHY and Intel PCI-Express Gigabit LAN
- Intel® GM45 Express VGA for CRT / LVDS
- 4x SATA, 8x USB 2.0, 4x COM, Watchdog timer
- 1x Mini PCI-E (Mini Card), 1x PCI-E (x16) slots

Checklist

Your MI945X package should include the items listed below.

- The MI945X Mini-ITX motherboard
- This User's Manual
- 1 CD containing chipset drivers and flash memory utility
- Cable kit (IDE, Serial port, Serial ATA)

MI945X Specifications

CPU Type	Intel® Mobile Core™2 Duo/Core™2 Quad Processor (Penryn) Intel® Celeron 5x5 Series
CPU Speed	Up to 2.93GHz
FSB	667/800/1066MHz FSB
L2 Cache	3MB or 6MB (P8000-series or P9000-series, T9000-series)
Green /APM	APM1.2
CPU Socket	Socket 478 "Type P" (Socket P) or micro-FCBGA on board
Chipset	Intel® GM45 (Cantiga) chipset - GMCH: AC82GM45 1329-pin FCBGA - ICH9M: AF82801IM 676-pin mBGA
BIOS	Award BIOS, support ACPI Function
Memory	DDR3 800/1066 (DDR3 1333/1600 not supported on GM45) - SoDIMM x2 <i>Dual-Channel</i> (w/o ECC), Max. 4GB
VGA & LVDS	Intel® GM45 built-in Intel gen.5.0 Graphics Media Accelerator (533MHz 1.05V), supports DirectX10 for CRT & LVDS (single/dual channel 18-bits/ 24-bit)
SDVO (DUAL CH)	None
Backlight control (LVDS)	- GMCH built-in control by PWM
LAN	1. Intel® ICH9M 10/100/gigabit MAC + PHY: • Intel 82567LM 10/100/1000 2. Intel 82574L PCI-e gigabit LAN controller x1
USB	ICH9M built-in USB 2.0 host controller, supports 8 ports
Serial ATA	ICH9M built-in SATA controller, supports 4 ports
Parallel IDE	JMicron JM368 (PCI-e to PATA) x1 for 1 PATA channel for IDE & CF
Audio	Intel® ICH9M built-in High Definition Audio controller ALC888 with 7.1 channels
LPC I/O	Winbond® W83627DHG: - IrDA x1, COM1 (RS232), COM2 (RS232/422/485), Hardware monitor - Fintek 81216G for COM 3 & COM4
Digital IO	4 in & 4 out
TPM1.2	ICH9M built-in iTPM version1.2 controller by firmware implement
Keyboard/Mouse Connector	Supports PS/2 Keyboard/Mouse
Expansion Slots	PCIe(x16) x1 and PCIe Minicard (30 x 56mm) x 1
Edge Connector	- PS/2 KB/Mouse connector - Gigabit LAN RJ45 + dual USB stack connector - Gigabit LAN RJ45 + dual USB stack connector - DB9 + DB15 stack connector x1 for COM 1 & VGA - RCA Jack 3x2 for HD Audio (Low Profile)
On Board Header/Connector	- 40-pin box-header x1 for IDE1 - PCIe Minicard x1 @ solder side - DF13 connector x2 for LVDS - 10-pin headerx1 for Digital I/O - 10-pin header x1 for COM2 - 20-pin header x1 for COM3/COM4 - 10-pin header x 2 for USB 5/6/7/8 - 10-pin header x1 for audio Line-Out & Mic - SATA connector x4 for 4 SATA ports - 26-pin box-header x1 for parallel port
Watchdog Timer	Yes (256 segments, 0, 1, 2...255 sec/min)
Board Size	170mm x 170mm

Board Dimensions

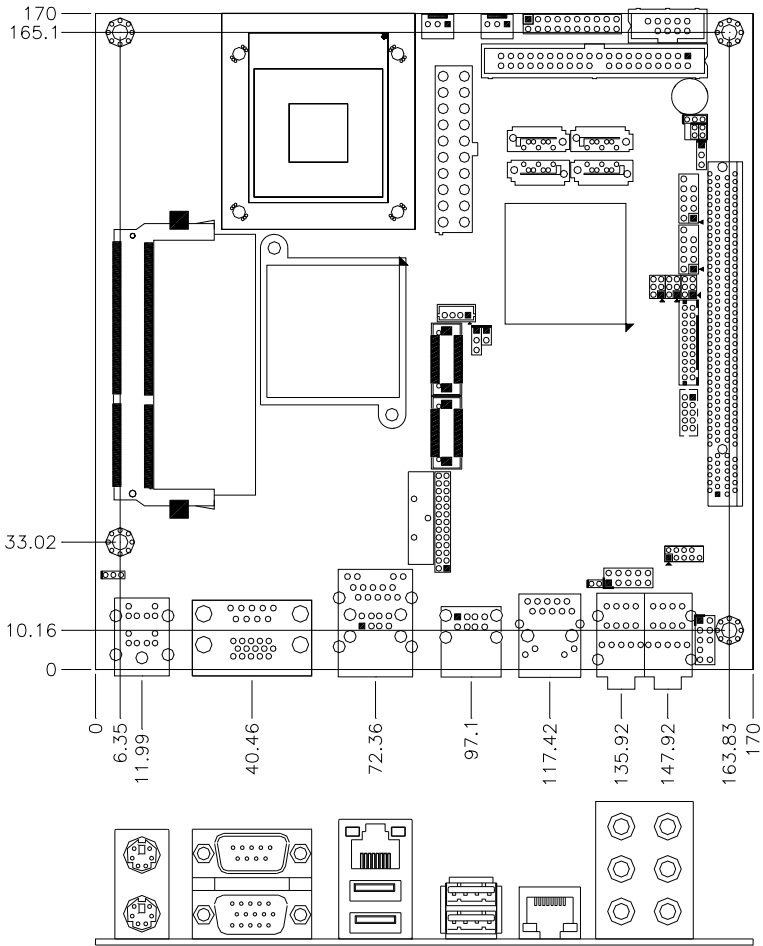

This page is intentionally left blank.

Installations

This section provides information on how to use the jumpers and connectors on the MI945X in order to set up a workable system. The topics covered are:

Installing the CPU	8
Installing the Memory	9
Setting the Jumpers.....	10
Connectors on MI945X.....	14

Installing the CPU

The MI945X board supports a Socket M socket for Intel® Core™ 2 Duo, Intel® Celeron mobile processors. The processor socket comes with a screw to secure the processor. As shown in the left picture below, loosen the screw first before inserting the processor. Place the processor into the socket by making sure the notch on the corner of the CPU corresponds with the notch on the inside of the socket. Once the processor has slide into the socket, fasten the screw. Refer to the figures below.

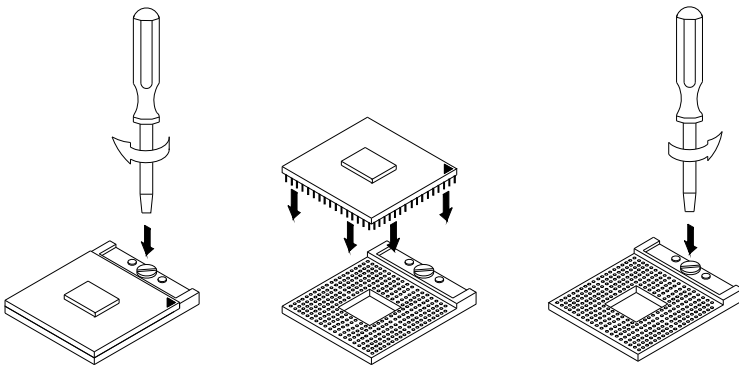

NOTE: Ensure that the CPU heat sink and the CPU top surface are in total contact to avoid CPU overheating problem that would cause your system to hang or be unstable.

Installing the Memory

The MI945X board supports two DDR3 memory socket for a maximum total memory of 4GB in DDR3 memory type.

Installing and Removing Memory Modules

To install the DDR3 modules, locate the memory slot on the board and perform the following steps:

1. Hold the DDR3 module so that the key of the DDR3 module aligned with that on the memory slot.
2. Gently push the DDR3 module in an upright position until the clips of the slot close to hold the DDR3 module in place when the DDR3 module touches the bottom of the slot.
3. To remove the DDR3 module, press the clips with both hands.

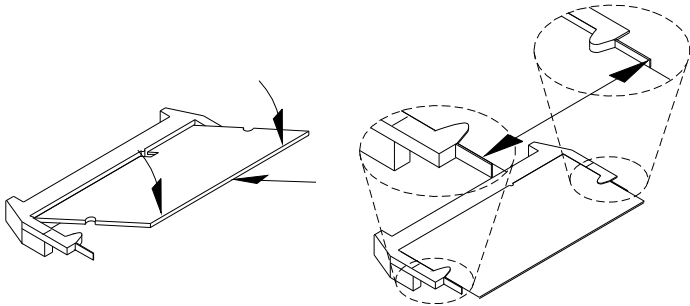

Setting the Jumpers

Jumpers are used on MI945X to select various settings and features according to your needs and applications. Contact your supplier if you have doubts about the best configuration for your needs. The following lists the connectors on MI945X and their respective functions.

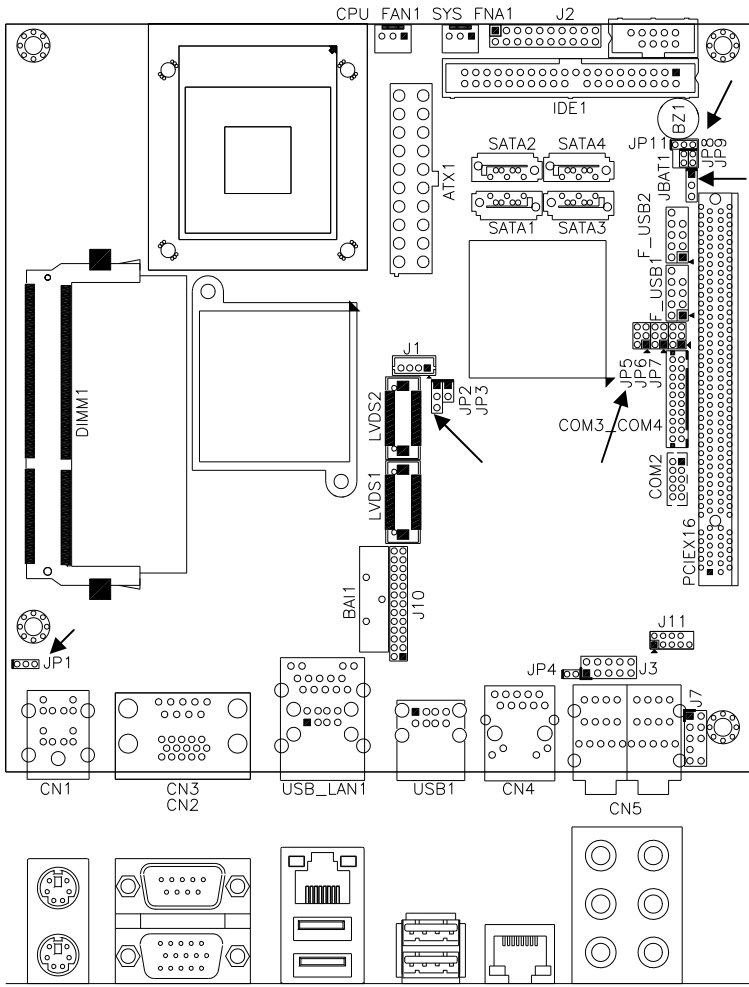

Jumper Locations on MI945X	11
JP1: Keyboard/Mouse Power Selection	12
JP2: LCD Panel Power Selection.....	12
JP5, JP6, JP7: RS232/422/485 (COM2) Selection	12
JP9: CompactFlash Slave/Master Selection.....	13
JBAT1: Clear CMOS Setting.....	13

Jumper Locations on MI945X





Jumpers on MI945X	Page
JP1: Keyboard/Mouse Power Selection	12
JP2: LCD Panel Power Selection	12
JP5, JP6, JP7: RS232/422/485 (COM2) Selection	12
JP9: CompactFlash Slave/Master Selection	13
JBAT1: Clear CMOS Setting	13

JP1: Keyboard/Mouse Power Selection

JP1	LCD Panel Power
	5V
	5VSB(Standby)

JP2: LCD Panel Power Selection

JP2	LCD Panel Power
	3.3V
	5V

JP5, JP6, JP7: RS232/422/485 (COM2) Selection

COM1 is fixed for RS-232 use only.

COM2 is selectable for RS232, RS-422 and RS-485.

The following table describes the jumper settings for COM2 selection.

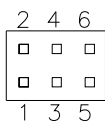



COM2 Function	RS-232	RS-422	RS-485
Jumper Setting (Pin closed)	JP5: 1-2	JP5: 3-4	JP5: 5-6
	JP6: 3-5 & 4-6	JP6: 1-3 & 2-4	JP6: 1-3 & 2-4
	JP7: 3-5 & 4-6	JP7: 1-3 & 2-4	JP7: 1-3 & 2-4



COM2 is jumper selectable for RS-232, RS-422 and RS-485.

Pin #	Signal Name		
	RS-232	R2-422	RS-485
1	DCD	TX-	DATA-
2	RX	TX+	DATA+
3	TX	RX+	NC
4	DTR	RX-	NC
5	Ground	Ground	Ground
6	DSR	RTS-	NC
7	RTS	RTS+	NC
8	CTS	CTS+	NC
9	RI	CTS-	NC
10	NC	NC	NC

JP9: CompactFlash Slave/Master Selection

JP9	CF Setting
 Short	Master
 Open	Slave

JBAT1: Clear CMOS Setting

JBAT1	Setting
 1 2 3	Normal
 1 2 3	Clear CMOS

Connectors on MI945X

Connector Locations on MI945X	15
CN1: PS/2 Keyboard and PS/2 Mouse Connectors	16
CN2, CN3: COM1 and VGA Connector	16
USB_LAN1: 10/100/1000 RJ-45 (MI945X) and USB1/2 Ports	17
USB1: USB3/4 Ports	17
CN4: GbE RJ-45 (MI945XF)	17
CN5: Audio Connector	17
ATX1: ATX Power Supply Connector	17
SYS_FAN1: System Fan Power Connector	17
CPU_FAN1: CPU Fan Power Connector	19
IDE1: IDE Connector	19
COM2: COM2 Serial Port	19
COM3_COM4: COM3, COM4 Serial Port	20
LVDS1, LVDS2: LVDS Connectors (1st channel, 2nd channel)	20
J1: LCD Backlight Connector	20
J2 (F_PANEL): System Function Connector	21
J3: Digital I/O	22
J4: SPI Flash Connector (factory use only)	22
J7: Front Audio Connector	22
J9: Compact Flash Connector	22
J10: Parallel Port Connector	23
J11: Reserved for factory use	23
F_USB1: USB5/USB6 Connector	23
F_USB2: USB7/USB8 Connector	23
JMINI: Mini PCIE Connector	23
SATA1, SATA2, SATA3, SATA4: SATA Connectors	23
PCIEX16: PCI-E(x16) Slot	23

Connector Locations on MI945X

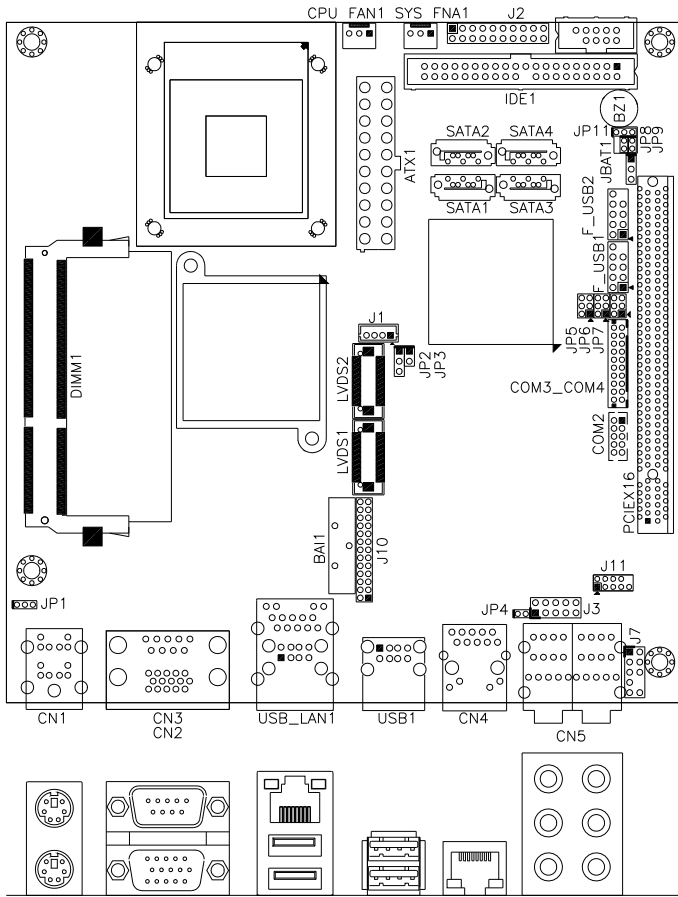

Connector Locations on MI945X

CN1: PS/2 Keyboard and PS/2 Mouse
CN2, CN3: COM1 and VGA Connector
USB_LAN1: RJ-45 and USB1/2 Ports
USB1: USB3/4 Ports
CN4: GbE RJ-45 (MI945XF)
CN5: Audio Connector
ATX1: ATX Power Supply
SYS_FAN1: System Fan Power
CPU_FAN1: CPU Fan Power
IDE1: IDE Connector
COM2: COM2 Serial Port
COM3_COM4: COM3, COM4
LVDS1, LVDS2: LVDS Connectors

J1: LCD Backlight Connector
J2 (F_PANEL): System Function
J3: Digital I/O
J4: SPI Flash Connector
J7: Front Audio Connector
J9: Compact Flash Connector
J10: Parallel Port Connector
J11: Reserved for factory use
F_USB1: USB5/USB6 Connector
F_USB2: USB7/USB8 Connector
JMINI: Mini PCIE Connector
SATA1, SATA2, SATA3, SATA4: SATA
PCIEX16: PCI-E(x16) Slot

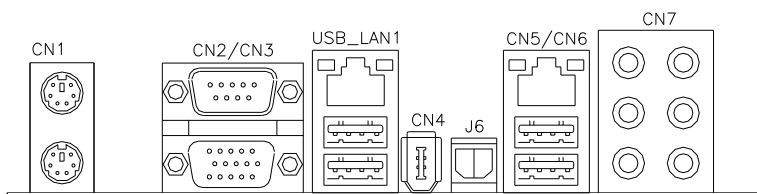

CN1: PS/2 Keyboard and PS/2 Mouse Connectors

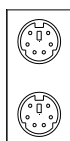

PS/2 Mouse

PS/2 Keyboard

Signal Name	Keyboard	Mouse	Signal Name
Keyboard data	1	1	Mouse data
N.C.	2	2	N.C.
GND	3	3	GND
5V	4	4	5V
Keyboard clock	5	5	Mouse clock
N.C.	6	6	N.C.

CN2, CN3: COM1 and VGA Connector

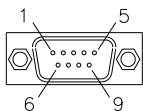

Signal Name	Pin #	Pin #	Signal Name
DCD	1	6	DSR
RXD	2	7	RTS
TXD	3	8	CTS
DTR	4	9	RI
GND	5	10	Not Used

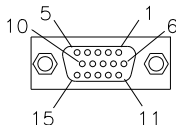

Signal Name	Pin #	Pin #	Signal Name
Red	1	2	Green
Blue	3	4	N.C.
GND	5	6	GND
GND	7	8	GND
N.C.	9	10	GND
N.C.	11	12	N.C.
HSYNC	13	14	VSYNC
NC	15		

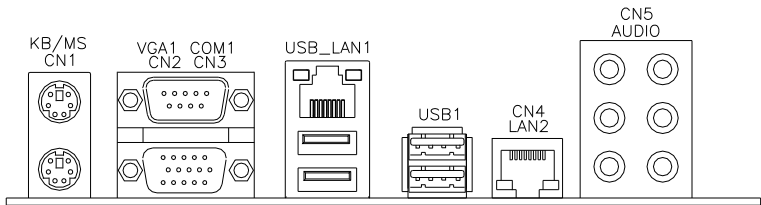

USB_LAN1: 10/100/1000 RJ-45 (MI945X) and USB1/2 Ports

USB1: USB3/4 Ports

CN4: GbE RJ-45 (MI945XF)

CN5: Audio Connector

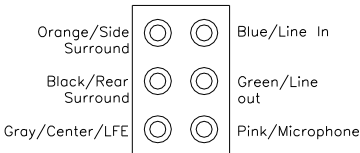

ATX1: ATX Power Supply Connector

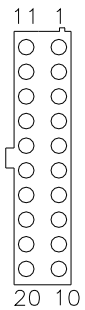

Signal Name	Pin #	Pin #	Signal Name
3.3V	11	1	3.3V
-12V	12	2	3.3V
Ground	13	3	Ground
PS-ON	14	4	+5V
Ground	15	5	Ground
Ground	16	6	+5V
Ground	17	7	Ground
-5V	18	8	Power good
+5V	19	9	5VSB
+5V	20	10	+12V

SYS_FAN1: System Fan Power Connector

FAN1 is a 3-pin header for system fans. The fan must be a 12V (500mA).



Pin #	Signal Name
1	Ground
2	+12V
3	Rotation detection

CPU_FAN1: CPU Fan Power Connector

This is a 3-pin header for the CPU fan. The fan must be a 12V fan.



Pin #	Signal Name
1	Ground
2	+12V
3	Rotation detection

IDE1: IDE Connector

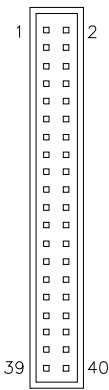

Signal Name	Pin #	Pin #	Signal Name
Reset IDE	1	2	Ground
Host data 7	3	4	Host data 8
Host data 6	5	6	Host data 9
Host data 5	7	8	Host data 10
Host data 4	9	10	Host data 11
Host data 3	11	12	Host data 12
Host data 2	13	14	Host data 13
Host data 1	15	16	Host data 14
Host data 0	17	18	Host data 15
Ground	19	20	Protect pin
DRQ0	21	22	Ground
Host IOW	23	24	Ground
Host IOR	25	26	Ground
IOCHRDY	27	28	Host ALE
DACK0	29	30	Ground
IRQ14	31	32	No connect
Address 1	33	34	No connect
Address 0	35	36	Address 2
Chip select 0	37	38	Chip select 1
Activity	39	40	Ground

COM2: COM2 Serial Port

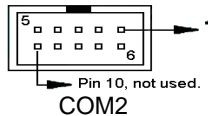

Signal Name	Pin #	Pin #	Signal Name
DCD, Data carrier detect	1	6	DSR, Data set ready
RXD, Receive data	2	7	RTS, Request to send
TXD, Transmit data	3	8	CTS, Clear to send
DTR, Data terminal ready	4	9	RI, Ring indicator
GND, ground	5	10	Not Used

COM3_COM4: COM3, COM4 Serial Port

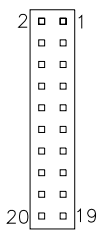

Signal Name	Pin #	Pin #	Signal Name
DSR	2	1	DCD
RTS	4	3	RXD
CTS	6	5	TXD
RI	8	7	DTR
NA	10	9	Ground
DSR	12	11	DCD
RTS	14	13	RXD
CTS	16	15	TXD
RI	18	17	DTR
NA	20	19	Ground

LVDS1, LVDS2: LVDS Connectors (1st channel, 2nd channel)

The LVDS connectors on board consist of the first channel (LVDS1) and second channel (LVDS2).

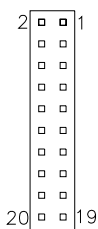

Signal Name	Pin #	Pin #	Signal Name
TX0-	2	1	TX0+
Ground	4	3	Ground
TX1-	6	5	TX1+
5V/3.3V	8	7	Ground
TX3-	10	9	TX3+
TX2-	12	11	TX2+
Ground	14	13	Ground
TXC-	16	15	TXC+
5V/3.3V	18	17	ENABKL
+12V	20	19	+12V

J1: LCD Backlight Connector



Pin #	Signal Name
1	+12V
2	Backlight Enable
3	Brightness Control
4	Ground

J2 (F_PANEL): System Function Connector

J2 provides connectors for system indicators that provide light indication of the computer activities and switches to change the computer status. J2 is a 20-pin header that provides interfaces for the following functions.

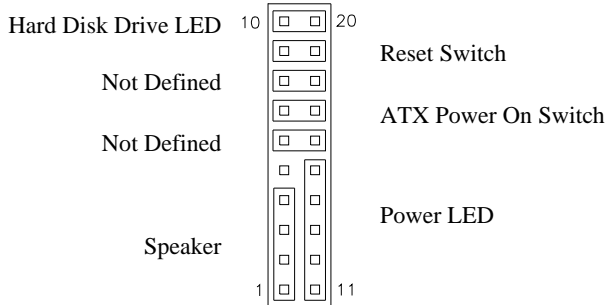

Speaker: Pins 1 - 4

This connector provides an interface to a speaker for audio tone generation. An 8-ohm speaker is recommended.

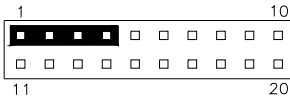

Pin #	Signal Name
1	Speaker out
2	No connect
3	Ground
4	+5V

Power LED: Pins 11 - 15

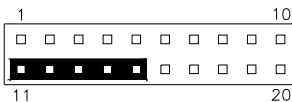

Pin #	Signal Name
11	Power LED
12	No connect
13	Ground
14	No connect
15	Ground

ATX Power ON Switch: Pins 7 and 17

This 2-pin connector is an “ATX Power Supply On/Off Switch” on the system that connects to the power switch on the case. When pressed, the power switch will force the system to power on. When pressed again, it will force the system to power off.

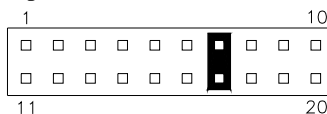

Reset Switch: Pins 9 and 19

The reset switch allows the user to reset the system without turning the main power switch off and then on again. Orientation is not required when making a connection to this header.

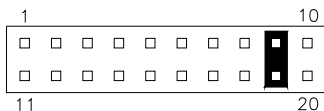

Hard Disk Drive LED Connector: Pins 10 and 20

This connector connects to the hard drive activity LED on control panel. This LED will flash when the HDD is being accessed.

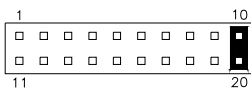

Pin #	Signal Name
10	HDD Active
20	5V

J3: Digital I/O



Signal Name	Pin	Pin	Signal Name
GND	1	2	VCC
OUT3	3	4	OUT1
OUT2	5	6	OUT0
IN3	7	8	IN1
IN2	9	10	IN0

J4: SPI Flash Connector (factory use only)

J7: Front Audio Connector

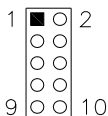

Signal Name	Pin #	Pin #	Signal Name
MIC2_L	1	2	Ground
MIC2_R	3	4	Presence#
Line2_L	5	6	MIC2_ID
Sense	7	8	NC
Line2_R	9	10	Line2_ID

J9: Compact Flash Connector

J10: Parallel Port Connector

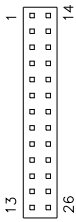

Signal Name	Pin #	Pin #	Signal Name
Line printer strobe	1	14	AutoFeed
PD0, parallel data 0	2	15	Error
PD1, parallel data 1	3	16	Initialize
PD2, parallel data 2	4	17	Select
PD3, parallel data 3	5	18	Ground
PD4, parallel data 4	6	19	Ground
PD5, parallel data 5	7	20	Ground
PD6, parallel data 6	8	21	Ground
PD7, parallel data 7	9	22	Ground
ACK, acknowledge	10	23	Ground
Busy	11	24	Ground
Paper empty	12	25	Ground
Select	13	N/A	N/A

J11: Reserved for factory use

F_USB1: USB5/USB6 Connector

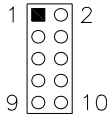

Signal Name	Pin	Pin	Signal Name
Vcc	1	2	Vcc
D0-	3	4	D1-
D0+	5	6	D1+
Ground	7	8	Ground
NC	9	10	Ground

F_USB2: USB7/USB8 Connector

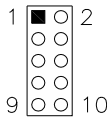

Signal Name	Pin	Pin	Signal Name
Vcc	1	2	Vcc
D0-	3	4	D1-
D0+	5	6	D1+
Ground	7	8	Ground
NC	9	10	Ground

JMINI: Mini PCIE Connector

SATA1, SATA2, SATA3, SATA4: SATA Connectors

PCIEX16: PCI-E(x16) Slot

BIOS Setup

This chapter describes the different settings available in the Award BIOS that comes with the board. The topics covered in this chapter are as follows:

BIOS Introduction.....	25
BIOS Setup.....	25
Standard CMOS Setup	27
Advanced BIOS Features.....	30
Advanced Chipset Features	33
Power Management Setup	39
PNP/PCI Configurations	42
PC Health Status.....	43
Frequency/Voltage Control	44
Load Fail-Safe Defaults	45
Load Optimized Defaults	45
Set Supervisor Password.....	45
Save & Exit Setup.....	45
Exit Without Saving.....	45

BIOS Introduction

The Award BIOS (Basic Input/Output System) installed in your computer system's ROM supports Intel processors. The BIOS provides critical low-level support for a standard device such as disk drives, serial ports and parallel ports. It also adds virus and password protection as well as special support for detailed fine-tuning of the chipset controlling the entire system.

BIOS Setup

The Award BIOS provides a Setup utility program for specifying the system configurations and settings. The BIOS ROM of the system stores the Setup utility. When you turn on the computer, the Award BIOS is immediately activated. Pressing the key immediately allows you to enter the Setup utility. If you are a little bit late pressing the key, POST (Power On Self Test) will continue with its test routines, thus preventing you from invoking the Setup. If you still wish to enter Setup, restart the system by pressing the "Reset" button or simultaneously pressing the <Ctrl>, <Alt> and <Delete> keys. You can also restart by turning the system Off and back On again. The following message will appear on the screen:

```
Press <DEL> to Enter Setup
```

In general, you press the arrow keys to highlight items, <Enter> to select, the <PgUp> and <PgDn> keys to change entries, <F1> for help and <Esc> to quit.

When you enter the Setup utility, the Main Menu screen will appear on the screen. The Main Menu allows you to select from various setup functions and exit choices.

Phoenix - AwardBIOS CMOS Setup Utility

Standard CMOS Features	Frequency/Voltage Control
Advanced BIOS Features	Load Fail-Safe Defaults
Advanced Chipset Features	Load Optimized Defaults
Integrated Peripherals	Set Supervisor Password
Power Management Setup	Set User Password
PnP/PCI Configurations	Save & Exit Setup
PC Health Status	Exit Without Saving
ESC: Quit	↑ ↓ → ← : Select Item
F10: Save & Exit Setup	
Time, Date, Hard Disk Type...	

The section below the setup items of the Main Menu displays the control keys for this menu. At the bottom of the Main Menu just below the control keys section, there is another section, which displays information on the currently highlighted item in the list.

Note: *If the system cannot boot after making and saving system changes with Setup, the Award BIOS supports an override to the CMOS settings that resets your system to its default.*

Warning: *It is strongly recommended that you avoid making any changes to the chipset defaults. These defaults have been carefully chosen by both Award and your system manufacturer to provide the absolute maximum performance and reliability. Changing the defaults could cause the system to become unstable and crash in some cases.*

Standard CMOS Setup

“Standard CMOS Setup” choice allows you to record some basic hardware configurations in your computer system and set the system clock and error handling. If the motherboard is already installed in a working system, you will not need to select this option. You will need to run the Standard CMOS option, however, if you change your system hardware configurations, the onboard battery fails, or the configuration stored in the CMOS memory was lost or damaged.

Phoenix - AwardBIOS CMOS Setup Utility
Standard CMOS Features

Date (mm:dd:yy)	Wed, Apr 28, 2007	Item Help
Time (hh:mm:ss)	00 : 00 : 00	Menu Level >
IDE Channel 0 Master	None	Change the day, month, Year and century
IDE Channel 1 Master	None	
IDE Channel 2 Master	None	
IDE Channel 2 Slave	None	
IDE Channel 3 Master	None	
IDE Channel 3 Slave	None	
IDE Channel 4 Master	None	
IDE Channel 4 Slave	None	
Video	EGA/VGA	
Halt On	All, but keyboard	
Base Memory	640K	
Extended Memory	129024K	
Total Memory	130048K	

At the bottom of the menu are the control keys for use on this menu. If you need any help in each item field, you can press the <F1> key. It will display the relevant information to help you. The memory display at the lower right-hand side of the menu is read-only. It will adjust automatically according to the memory changed. The following describes each item of this menu.

Date

The date format is:

Day: Sun to Sat
Month: 1 to 12
Date: 1 to 31
Year: 1999 to 2099

To set the date, highlight the “Date” field and use the PageUp/PageDown or +/- keys to set the current time.

Time

The time format is: **Hour** : 00 to 23
 Minute : 00 to 59
 Second : 00 to 59

To set the time, highlight the “Time” field and use the <PgUp>/<PgDn> or +/- keys to set the current time.

IDE Channel Master/Slave

The onboard PCI IDE connector provides Primary and Secondary channels for connecting up to two IDE hard disks or other IDE devices.

Press <Enter> to configure the hard disk. The selections include Auto, Manual, and None. Select ‘Manual’ to define the drive information manually. You will be asked to enter the following items.

CYLS : Number of cylinders
HEAD : Number of read/write heads
PRECOMP : Write precompensation
LANDING ZONE : Landing zone
SECTOR : Number of sectors

The Access Mode selections are as follows:

CHS (HD < 528MB)
LBA (HD > 528MB and supports
 Logical Block Addressing)
Large (for MS-DOS only)
Auto

Video

This field selects the type of video display card installed in your system.

You can choose the following video display cards:

EGA/VGA	For EGA, VGA, SEGA, SVGA or PGA monitor adapters. (default)
CGA 40	Power up in 40 column mode.
CGA 80	Power up in 80 column mode.
MONO	For Hercules or MDA adapters.

Halt On

This field determines whether or not the system will halt if an error is detected during power up.

No errors	The system boot will not be halted for any error that may be detected.
All errors	Whenever the BIOS detects a non-fatal error, the system will stop and you will be prompted.
All, But Keyboard	The system boot will not be halted for a keyboard error; it will stop for all other errors
All, But Diskette	The system boot will not be halted for a disk error; it will stop for all other errors.
All, But Disk/Key	The system boot will not be halted for a keyboard or disk error; it will stop for all others.

Advanced BIOS Features

This section allows you to configure and improve your system and allows you to set up some system features according to your preference.

Phoenix - AwardBIOS CMOS Setup Utility
Advanced BIOS Features

		ITEM HELP
CPU Feature	Press Enter	
Hard Disk Boot Priority	Press Enter	
Virus Warning	Disabled	Menu Level >
CPU L3 Cache	Enabled	
Quick Power On Self Test	Enabled	
First Boot Device	Removable	
Second Boot Device	Hard Disk	
Third Boot Device	CDROM	
Boot Other Device	Enabled	
Boot Up NumLock Status	On	
Gate A20 Option	Fast	
Typeomatic Rate Setting	Disabled	
Typeomatic Rate (Chars/Sec)	6	
Typeomatic Delay (Msec)	250	
Security Option	Setup	
APIC Mode	Enabled	
MPS Version Control for OS	1.4	
OS Select For DRAM>64MB	Non-OS2	
Small Logo (EPA) Show	Disabled	
Summary Screen Show	Disabled	

CPU Feature

Press Enter to configure the settings relevant to CPU Feature.

Hard Disk Boot Priority

With the field, there is the option to choose, aside from the hard disks connected, “Bootable add-in Cards” which refers to other external devices.

Virus Warning

If this option is enabled, an alarm message will be displayed when trying to write on the boot sector or on the partition table on the disk, which is typical of the virus.

Quick Power On Self Test

When enabled, this field speeds up the Power On Self Test (POST) after the system is turned on. If it is set to *Enabled*, BIOS will skip some items.

First/Second/Third Boot Device

These fields determine the drive that the system searches first for an operating system. The options available include *Removable*, *Hard Disk*, *CDROM*, *Legacy LAN* and *Disable*.

Boot Other Device

These fields allow the system to search for an OS from other devices other than the ones selected in the First/Second/Third Boot Device.

Boot Up NumLock Status

This allows you to activate the NumLock function after you power up the system.

Gate A20 Option

This field allows you to select how Gate A20 is worked. Gate A20 is a device used to address memory above 1 MB.

Typematic Rate Setting

When disabled, continually holding down a key on your keyboard will generate only one instance. When enabled, you can set the two typematic controls listed next. By default, this field is set to *Disabled*.

Typematic Rate (Chars/Sec)

When the typematic rate is enabled, the system registers repeated keystrokes speeds. Settings are from 6 to 30 characters per second.

Typematic Delay (Msec)

When the typematic rate is enabled, this item allows you to set the time interval for displaying the first and second characters. By default, this item is set to *250msec*.

Security Option

This field allows you to limit access to the System and Setup. The default value is *Setup*. When you select *System*, the system prompts for the User Password every time you boot up. When you select *Setup*, the system always boots up and prompts for the Supervisor Password only when the Setup utility is called up.

APIC Mode

APIC stands for Advanced Programmable Interrupt Controller. The default setting is *Enabled*.

MPS Version Control for OS

This option is specifies the MPS (Multiprocessor Specification) version for your operating system. MPS version 1.4 added extended configuration tables to improve support for multiple PCI bus configurations and improve future expandability. The default setting is *1.4*.

OS Select for DRAM > 64MB

This option allows the system to access greater than 64MB of DRAM memory when used with OS/2 that depends on certain BIOS calls to access memory. The default setting is *Non-OS/2*.

Small Logo (EPA) Show

The EPA logo appears at the right side of the monitor screen when the system is boot up. The default setting is *Disabled*.

Summary Screen Show

The screen shows a summary of device listing. The default setting is *Disabled*.

Advanced Chipset Features

This Setup menu controls the configuration of the chipset.

Phoenix - AwardBIOS CMOS Setup Utility
Advanced Chipset Features

		ITEM HELP
System BIOS Cacheable	Enabled	
Memory Hole at 15M-16M	Disabled	
Support FSB and DDR3 667Mhz	Disabled	
PCI Express Root Port Func	Press Enter	
VT-d	Disable	
** VGA Setting **		
PEG/Onchip VGA Control	Auto	
PEG Force X1	Disabled	
On-Chip Frame Buffer Size	64MB	
DVMT Mode	Enable	
Total GFX Memory	128MB	
PAVP Mode	PAVP-Lite	
** VGA Boot Device Setting **		
Boot Display	CRT + LVDS	
SDVO Device Setting	None	
SDVO LVDS Protocol	1 Ch SPGW,24bit	
SDVO Panel Number	1024x768	
Active LVDS Device	No LVDS	
Integrated LVDS Protocol	18bit	
Panel Scaling	AUTO	
Panel Type	1024x768 SC/DC	

System BIOS Cacheable

The setting of *Enabled* allows caching of the system BIOS ROM at F000h-FFFFFh, resulting in better system performance. However, if any program writes to this memory area, a system error may result.

Memory Hole At 15M-16M

In order to improve performance, certain space in memory can be reserved for ISA cards. This memory must be mapped into the memory space below 16 MB. The choices are *Enabled* and *Disabled*.

Support FSB and DDR3 667Mhz

The options are *Enabled* and *Disabled*.

VT-d

The options are *Enabled* and *Disabled*.

VGA Setting

The fields and the default setting for the VGA Setting are as follows:

PEG/Onchip VGA Control	Auto
PEG Force X1	Disabled
On-Chip Frame Buffer Size	64MB
DVMT Mode	Enable
Total GFX Memory	128MB
PAVP Mode	PAVP-Lite

PEG/Onchip VGA Control

The options are *Onchip VGA*, *PEG Port* and *Auto*.

PEG Force X1

The options are *Enabled* and *Disabled*.

On-Chip Frame Buffer Size

The options are *32MB*, *64MB* and *128MB*.

DVMT Mode

The options are *Enabled* and *Disabled*.

Total GFX Memory

The options are *128MB*, *256MB* and *Max*.

PAVP Mode

The options are *Disabled*, *PAVP-Lite* and *PAVP-High*.

VGA Boot Device Setting

The fields and the default setting for this section are as follows:

Boot Display	CRT + LVDS
SDVO Device Setting	None
SDVO LVDS Protocol	1 Ch SPGW,24bit
SDVO Panel Number	1024x768
Active LVDS Device	No LVDS
Integrated LVDS Protocol	18bit
Panel Scaling	AUTO
Panel Type	1024x768 SC/DC

Boot Display

The options are *CRT*, *LVDS*, *CRT + LVDS*, *DVI* and *CRT + DVI*.

SDVO Device Setting

The options are *None*, *LVDS*, *DVI* and *CRT*.

SDVO LVDS Protocol

The options are:

1ch	SPGW, 24bit
2ch	SPGW, 24bit
1ch	OpenLDI, 24bit
2ch	OpenLDI, 24bit
1ch	18bit
2ch	18bit

SDVO Panel Number

The options are:

800x600
852x480
1024x768
1366x768
1400x1050
1600x1200
1920x1080

Active LVDS Device

The options are *No LVDS*, *Integrated LVDS* and *SDVO LVDS*.

Integrated LVDS Protocol

The options are *18bit* and *24bit*.

Panel Scaling

The default setting is *AUTO*. The options are *AUTO*, *FORCE OFF* and *Maintain Aspect Ratio*.

Panel Number

The options are:

640x480	SC/DC
800x600	SC/DC
1024x768	SC/DC
1280x600	SC/DC
1280x768	SC/DC
1280x800	SC/DC
1280x1024	SC/DC
1400x1050	SC/DC
1680x1200	SC/DC
1920x1200	SC/DC
2048x1536	SC/DC

Integrated Peripherals

This section sets configurations for your hard disk and other integrated peripherals. The first screen shows three main items for user to select. Once an item selected, a submenu appears. Details follow.

Phoenix - AwardBIOS CMOS Setup Utility
Integrated Peripherals

OnChip IDE Device	Press Enter	ITEM HELP
SuperIO Device	Press Enter	Menu Level >
2nd SuperIO Device	Press Enter	
USB Device Setting	Press Enter	

Phoenix - AwardBIOS CMOS Setup Utility
OnChip IDE Device

IDE HDD Block Mode	Enabled	ITEM HELP
IDE DMA transfer access	Enable	Menu Level >
IDE Primary Master PIO	Auto	
IDE Primary Slave PIO	Auto	
IDE Primary Master UDMA	Auto	
IDE Primary Slave UDMA	Auto	
On-Chip Secondary PCI IDE	Enabled	
IDE Secondary Master PIO	Auto	
IDE Secondary Slave PIO	Auto	
IDE Secondary Master UDMA	Auto	
IDE Secondary Slave UDMA	Auto	
SATA Mode	IDE	
LEGACY Mode Support	Disabled	

Phoenix - AwardBIOS CMOS Setup Utility
SuperIO Device

POWER ON Function	BUTTON ONLY	ITEM HELP
Onboard Serial Port 1	3F8/IRQ4	Menu Level >
Onboard Serial Port 2	2F8/IRQ3	
Onboard Parallel Port	378/IRQ7	
Parallel Port Mode	SPP	
PWRON After PWR-Fail	Off	

Phoenix - AwardBIOS CMOS Setup Utility
2nd SuperIO Device

Onboard Serial Port 3	230h	
Serial Port 3 Use IRQ	IRQ5	
Onboard Serial Port 4	238h	
Serial Port 4 Use IRQ	IRQ11	

IDE HDD Block Mode

This field allows your hard disk controller to use the fast block mode to transfer data to and from your hard disk drive.

IDE DMA transfer access

This field, by default, is enabled

On-chip Primary/Secondary PCI IDE

The integrated peripheral controller contains an IDE interface with support for two IDE channels. Select *Enabled* to activate each channel separately.

IDE Primary/Secondary Master/Slave PIO

These fields allow your system hard disk controller to work faster. Rather than have the BIOS issue a series of commands that transfer to or from the disk drive, PIO (Programmed Input/Output) allows the BIOS to communicate with the controller and CPU directly.

The system supports five modes, numbered from 0 (default) to 4, which primarily differ in timing. When Auto is selected, the BIOS will select the best available mode.

IDE Primary/Secondary Master/Slave UDMA

These fields allow your system to improve disk I/O throughput to 33Mb/sec with the Ultra DMA/33 feature. The options are *Auto* and *Disabled*.

SATA Mode

The options include *IDE* and *AHCI*.

Legacy Mode Support

The options are *Disabled* and *Enabled*.

Power ON Function

This field is related to how the system is powered on – such as with the use of conventional power button, keyboard or hot keys. The options are *Password*, *Hot KEY*, *Mouse Left*, *Mouse Right*, *Any KEY*, *BUTTON ONLY* and *Keyboard 98*.

KB Power ON Password

This field allows users to set the password when keyboard power on is the mode of the Power ON function.

Hot Key Power ON

This field sets certain keys, also known as hot keys, on the keyboard that can be used as a 'switch' to power on the system.

Onboard Serial Ports

These fields allow you to select the onboard serial ports and their addresses. The default values for these ports are:

- Serial Port 1 3F8/IRQ4
- Serial Port 2 2F8/IRQ3
- Serial Port 3 230h/IRQ5
- Serial Port 4 238h/IRQ11

PWRON After PWR-Fail

This field sets the system power status whether *on* or *off* when power returns to the system from a power failure situation.

Phoenix - AwardBIOS CMOS Setup Utility
USB Device Setting

USB 1.0 Controller	Enabled	ITEM HELP Menu Level >
USB 2.0 Controller	Enabled	
USB Keyboard Function	Enabled	
USB Mouse Function	Disable	
USB Storage Function	Enabled	
*** USB Mass Storage Device Boot Setting ***		

USB 1.0 Controller

The options for this field are *Enabled* and *Disabled*. By default, this field is set to *Enabled*.

USB 2.0 Controller

The options for this field are *Enabled* and *Disabled*. By default, this field is set to *Enabled*. In order to use USB 2.0, necessary OS drivers must be installed first. **Please update your system to Windows XP SP2.**

USB Keyboard/Mouse/Storage Function

The options for these fields are *Enabled* and *Disabled*.

Power Management Setup

Phoenix - AwardBIOS CMOS Setup Utility
Power Management Setup

		ITEM HELP
PCI Express PM Function	Press Enter	Menu Level >
ACPI Function	Enabled	
ACPI Suspend	S3(STR)	
RUN VGABIOS if S3 Resume	Auto	
Power Management	User Define	
Video Off Method	V/H SYNC+Blank	
Video Off In Suspend	Yes	
Suspend Type	Stop Grant	
Modem Use IRQ	3	
Suspend Mode	Disabled	
HDD Power Down	Disabled	
Soft-Off by PWR-BTTN	Instant-Off	
CPU THRM Throttling	50%	
Wake-Up by PCI Card	Disabled	
Power On by Ring	Disabled	
USB KB Wake Up from S3	Disabled	
Resume by Alarm	Disabled	
Date (of Month) Alarm	0	
Time (hh:mm:ss) Alarm	0 : 0 : 0	
** Reload Global Timer Events **		
Primary IDE 0	Disabled	
Primary IDE 1	Disabled	
Secondary IDE 0	Disabled	
Secondary IDE 1	Disabled	
FDD, COM, LPT Port	Disabled	
PCI PIRQ[A-D] #	Disabled	

PCI Express PM Function

The options within this field that can be enabled or disabled include *PEG Port ASPM*, *Root Port ASPM* and *DMI Port ASPM*.

ACPI Function

Enable this function to support ACPI (Advance Configuration and Power Interface).

ACPI Suspend

The default setting of the ACPI Suspend mode is *S3(STR)*.

RUN VGABIOS if S3 Resume

The default setting of this field is *Auto*.

Power Management

This field allows you to select the type of power saving management modes. There are four selections for Power Management.

Min. Power Saving	Minimum power management
Max. Power Saving	Maximum power management.
User Define	Each of the ranges is from 1 min. to 1hr. Except for HDD Power Down which ranges from 1 min. to 15 min.

Video Off Method

This field defines the Video Off features. There are three options.

V/H SYNC + Blank	Default setting, blank the screen and turn off vertical and horizontal scanning.
DPMS	Allows BIOS to control the video display.
Blank Screen	Writes blanks to the video buffer.

Video Off In Suspend

When enabled, the video is off in suspend mode.

Suspend Type

The default setting for the Suspend Type field is *Stop Grant*.

Modem Use IRQ

This field sets the IRQ used by the Modem. By default, the setting is 3.

Suspend Mode

When enabled, and after the set time of system inactivity, all devices except the CPU will be shut off.

HDD Power Down

When enabled, and after the set time of system inactivity, the hard disk drive will be powered down while all other devices remain active.

CPU THRM-Throttling

This field is related to the speed of the processor that drops when the CPU temperature reaches the threshold as set in the CPU Warning Temperature of the PC Health Status section. The options in this field include 75%, 50% and 25%.

Soft-Off by PWR-BTN

This field defines the power-off mode when using an ATX power supply. The *Instant Off* mode allows powering off immediately upon pressing the power button. In the *Delay 4 Sec* mode, the system powers off when the power button is pressed for more than four seconds or enters the suspend mode when pressed for less than 4 seconds.

Wake up by PCI Card

By default, this field is disabled.

Power On by Ring

This field enables or disables the power on of the system through the modem connected to the serial port or LAN.

USB KB Wake Up by S3

This field has a default setting of *Disabled*.

Resume by Alarm

This field enables or disables the resumption of the system operation. When enabled, the user is allowed to set the *Date* and *Time*.

Reload Global Timer Events

The HDD, FDD, COM, LPT Ports, and PCI PIRQ are I/O events that can prevent the system from entering a power saving mode or can awaken the system from such a mode. When an I/O device wants to gain the attention of the operating system, it signals this by causing an IRQ to occur. When the operating system is ready to respond to the request, it interrupts itself and performs the service.

PNP/PCI Configurations

This option configures the PCI bus system. All PCI bus systems on the system use INT#, thus all installed PCI cards must be set to this value.

Phoenix - AwardBIOS CMOS Setup Utility
PnP/PCI Configurations

Init Display First	PCI Slot	ITEM HELP Menu Level Select Yes if you are using a Plug and Play capable operating system Select No if you need the BIOS to configure non-boot devices
Reset Configuration Data	Disabled	
Resources Controlled By	Auto (ESCD)	
IRQ Resources	Press Enter	
PCI/VGA Palette Snoop	Disabled	
PCI Express relative items		
Maximum Payload Size	128	

Init Display First

The default setting is *PCI Card*.

Reset Configuration Data

This field allows you to determine whether to reset the configuration data or not. The default value is *Disabled*.

Resources Controlled by

This PnP BIOS can configure all of the boot and compatible devices with the use of a PnP operating system such as Windows 95.

PCI/VGA Palette Snoop

Some non-standard VGA display cards may not show colors properly. This field allows you to set whether or not MPEG ISA/VESA VGA cards can work with PCI/VGA. When this field is enabled, a PCI/VGA can work with an MPEG ISA/VESA VGA card. When this field is disabled, a PCI/VGA cannot work with an MPEG ISA/VESA card.

Maximum Payload Size

The default setting of the PCI Express Maximum Payload Size is 128.

PC Health Status

This section shows the parameters in determining the PC Health Status. These parameters include temperatures, fan speeds and voltages.

Phoenix - AwardBIOS CMOS Setup Utility
PC Health Status

		ITEM HELP
Shutdown Temperature	Disabled	
CPU Warning Temperature	Disabled	
Current System Temp.	45°C/113°F	
Current CPU Temp.	45°C/113°F	
Current Chassis Temp.	50°C/122°F	
System Fan Speed	5400 RPM	
CPU Fan Speed	6250 RPM	
Vcore(V)	1.12 V	
12 V	12.08 V	
1.5V	1.56 V	
5V	4.96 V	
3.3V	3.37V	
VBAT (V)	3.21 V	
3VSB(V)	3.13 V	
CPU Smart Fan Temp.	Disabled	
SystemSmart Fan Temp.	Disabled	
		Menu Level >

Shutdown Temperature

This field allows the user to set the temperature by which the system automatically shuts down once the threshold temperature is reached. This function can help prevent damage to the system that is caused by overheating.

CPU Warning Temperature

This field allows the user to set the temperature so that when the temperature is reached, the system sounds a warning. This function can help prevent damage to the system that is caused by overheating.

Temperatures/Voltages

These fields are the parameters of the hardware monitoring function feature of the motherboard. The values are read-only values as monitored by the system and show the PC health status.

Smart Fan Temperature

This field enables or disables the smart fan feature. At a certain temperature, the fan starts turning. Once the temperature drops to a certain level, it stops turning again.

Frequency/Voltage Control

This section shows the user how to configure the processor frequency.

Phoenix - AwardBIOS CMOS Setup Utility
Frequency/Voltage Control

Auto Detect PCI Clk	Disabled	ITEM HELP
Spread Spectrum Modulated	Disabled	Menu Level >
CPU Host/SRC/PCI Clock	Default	

Auto Detect PCI Clk

This field enables or disables the auto detection of the PCI clock.

Spread Spectrum Modulated

This field sets the value of the spread spectrum. The default setting is *Disabled*. This field is for CE testing use only.

CPU Host/SRC/PCI Clock

The options are *100/100/33MHz*, *133/100/33MHz*, *166/100/33MHz*, *200/100/33MHz*, *266/100/33MHz*, and *333/100/33MHz*.

Load Fail-Safe Defaults

This option allows you to load the troubleshooting default values permanently stored in the BIOS ROM. These default settings are non-optimal and disable all high-performance features.

Load Optimized Defaults

This option allows you to load the default values to your system configuration. These default settings are optimal and enable all high performance features.

Set Supervisor Password

These two options set the system password. Supervisor Password sets a password that will be used to protect the system and Setup utility. User Password sets a password that will be used exclusively on the system. To specify a password, highlight the type you want and press <Enter>. The Enter Password: message prompts on the screen. Type the password, up to eight characters in length, and press <Enter>. The system confirms your password by asking you to type it again. After setting a password, the screen automatically returns to the main screen.

To disable a password, just press the <Enter> key when you are prompted to enter the password. A message will confirm the password to be disabled. Once the password is disabled, the system will boot and you can enter Setup freely.

Save & Exit Setup

This option allows you to determine whether or not to accept the modifications. If you type “Y”, you will quit the setup utility and save all changes into the CMOS memory. If you type “N”, you will return to Setup utility.

Exit Without Saving

Select this option to exit the Setup utility without saving the changes you have made in this session. Typing “Y” will quit the Setup utility without saving the modifications. Typing “N” will return you to Setup utility.

Drivers Installation

This section describes the installation procedures for software and drivers under Windows XP. The software and drivers are included with the motherboard. If you find the items missing, please contact the vendor where you made the purchase. The contents of this section include the following:

Intel Chipset Software Installation Utility	47
VGA Drivers Installation.....	49
High Definition Codec Audio Driver Installation	51
LAN Drivers Installation	52

IMPORTANT NOTE:

After installing your Windows operating system (Windows XP), you must install first the Intel Chipset Software Installation Utility before proceeding with the drivers installation.

Intel Chipset Software Installation Utility

The Intel Chipset Drivers should be installed first before the software drivers to enable Plug & Play INF support for Intel chipset components. Follow the instructions below to complete the installation.

1. Insert the CD that comes with the board. Click **Intel** and then **Intel(R) GM45 Chipset Drivers**.
2. Click **Intel(R) Chipset Software Installation Utility**.



3. When the Welcome screen to the Intel® Chipset Device Software appears, click **Next** to continue.

4. Click ***Yes*** to accept the software license agreement and proceed with the installation process.
5. On the Readme File Information screen, click ***Next*** to continue the installation.
6. The Setup process is now complete. Click ***Finish*** to restart the computer and for changes to take effect.

VGA Drivers Installation

To install the VGA drivers, follow the steps below to proceed with the installation.

1. Insert the CD that comes with the board. Click **Intel** and then **Intel(R) GM45 Chipset Drivers**.
2. Click **Intel(R) GM45 Chipset Family Graphics Driver**.

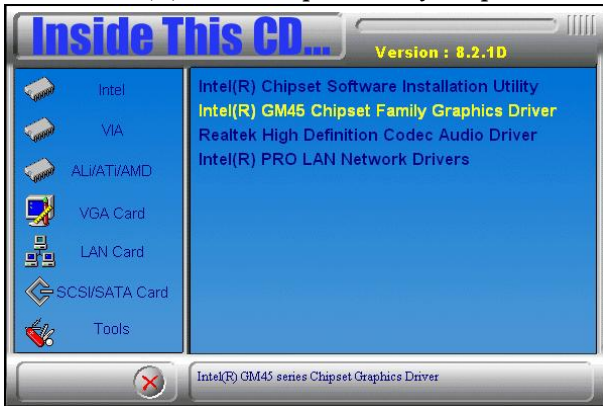

3. When the Welcome screen to the Setup Program appears, click **Next** to continue.



4. Click **Yes** to agree with the license agreement and continue the installation.
5. On the Readme File Information screen, click **Next** to continue the installation of the Intel® Graphics Media Accelerator Driver.
6. On Setup Progress screen, click **Next** to continue.
7. Setup complete. Click **Finish** to restart the computer and for changes to take effect.

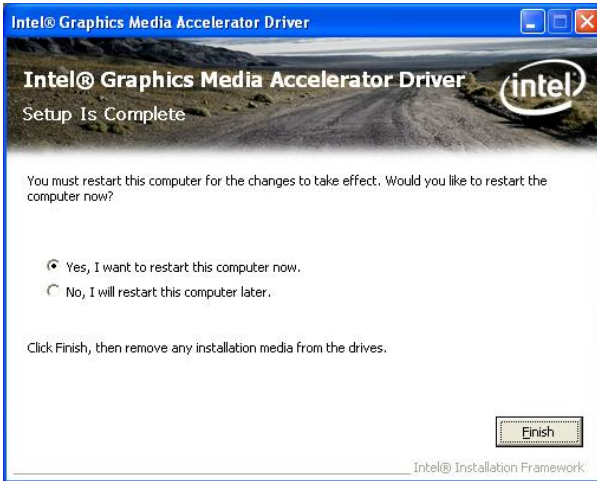

High Definition Codec Audio Driver Installation

1. Insert the drivers CD. Click *Intel* and then *Intel(R) GM45 Chipset Drivers*. Click *Realtek High Definition Codec Audio Driver*.



2. On the Welcome to the InstallShield Wizard screen, click *Next*.

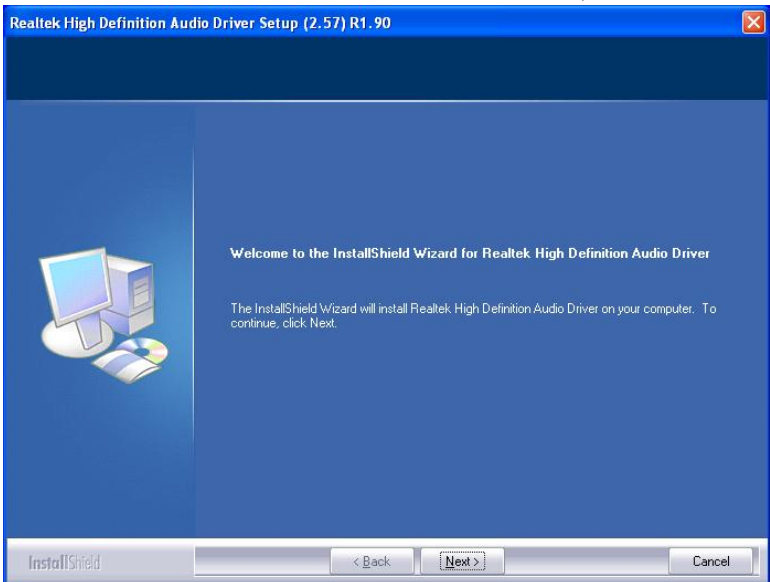

3. InstallShield Wizard is complete. Click *Finish* to restart the computer.

LAN Drivers Installation

Follow the steps below to install the Intel LAN drivers. *This one installation will cover both 82574L and 82567LM LAN controllers.*

1. Insert the CD that comes with the motherboard. Click **LAN Card** and then **Intel(R) PRO 82574L LAN Drivers**.

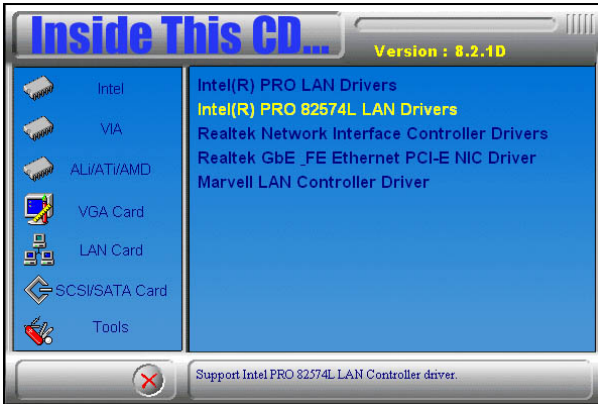

2. When the Welcome screen to the InstallShield Wizard for Intel® Network Connections appears, click **Next**. On the next screen, click **Yes** to agree with the license agreement.

3. Click the checkbox for **Drivers** in the Setup Options screen to select it and click **Next** to continue.

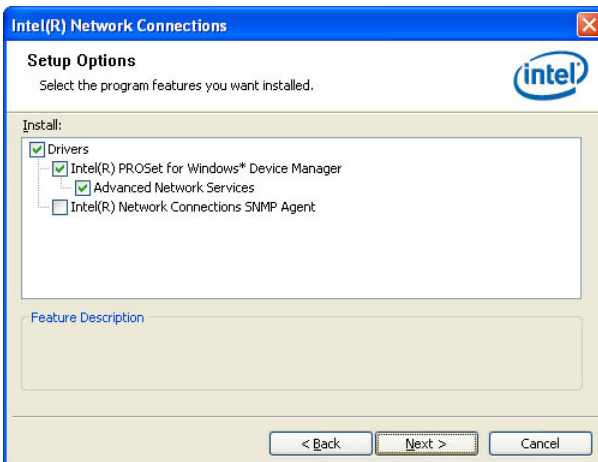

4. The wizard is ready to begin installation. Click **Install** to begin the installation.

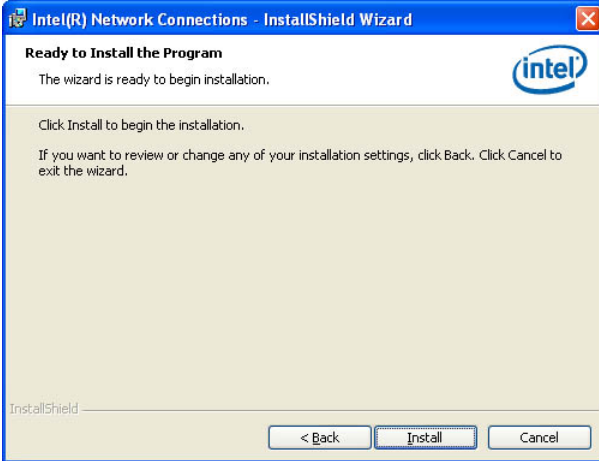

5. When InstallShield Wizard is complete, click **Finish**.

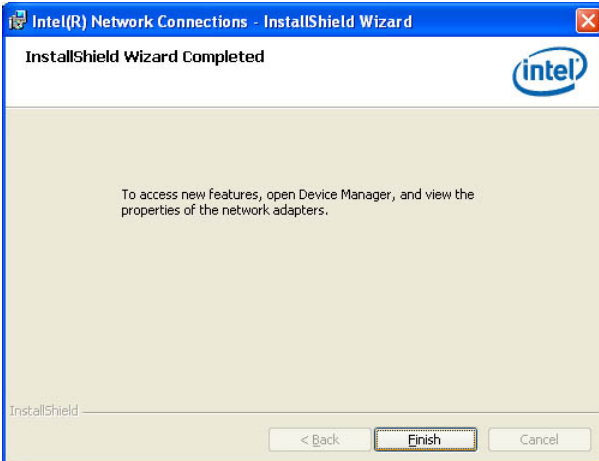

Remarks: This Intel® PRO 82574L LAN drivers support both Intel 82574L and 82567LM LAN controllers.

Appendix

A. I/O Port Address Map

Each peripheral device in the system is assigned a set of I/O port addresses which also becomes the identity of the device. The following table lists the I/O port addresses used.

Address	Device Description
000h - 01Fh	DMA Controller #1
020h - 03Fh	Interrupt Controller #1
040h - 05Fh	Timer
060h - 06Fh	Keyboard Controller
070h - 07Fh	Real Time Clock, NMI
080h - 09Fh	DMA Page Register
0A0h - 0BFh	Interrupt Controller #2
0C0h - 0DFh	DMA Controller #2
0F0h	Clear Math Coprocessor Busy Signal
0F1h	Reset Math Coprocessor
1F0h - 1F7h	IDE Interface
278 - 27F	Parallel Port #2(LPT2)
2F8h - 2FFh	Serial Port #2(COM2)
2B0 - 2DF	Graphics adapter Controller
378h - 3FFh	Parallel Port #1(LPT1)
360 - 36F	Network Ports
3B0 - 3BF	Monochrome & Printer adapter
3C0 - 3CF	EGA adapter
3D0 - 3DF	CGA adapter
3F0h - 3F7h	Floppy Disk Controller
3F8h - 3FFh	Serial Port #1(COM1)

B. Interrupt Request Lines (IRQ)

Peripheral devices use interrupt request lines to notify CPU for the service required. The following table shows the IRQ used by the devices on board.

Level	Function
IRQ0	System Timer Output
IRQ1	Keyboard
IRQ2	Interrupt Cascade
IRQ3	Serial Port #2
IRQ4	Serial Port #1
IRQ5	Reserved
IRQ6	Floppy Disk Controller
IRQ7	Parallel Port #1
IRQ8	Real Time Clock
IRQ9	Reserved
IRQ10	Reserved
IRQ11	Reserved
IRQ12	PS/2 Mouse
IRQ13	80287
IRQ14	Primary IDE
IRQ15	Secondary IDE

C. Watchdog Timer Configuration

The WDT is used to generate a variety of output signals after a user programmable count. The WDT is suitable for use in the prevention of system lock-up, such as when software becomes trapped in a deadlock. Under these sorts of circumstances, the timer will count to zero and the selected outputs will be driven. Under normal circumstance, the user will restart the WDT at regular intervals before the timer counts to zero.

SAMPLE CODE:

```
//-----
//
// THIS CODE AND INFORMATION IS PROVIDED "AS IS" WITHOUT WARRANTY OF ANY
// KIND, EITHER EXPRESSED OR IMPLIED, INCLUDING BUT NOT LIMITED TO THE
// IMPLIED WARRANTIES OF MERCHANTABILITY AND/OR FITNESS FOR A PARTICULAR
// PURPOSE.
//
//-----
#include <dos.h>
#include <conio.h>
#include <stdio.h>
#include <stdlib.h>
#include "W627DHG.H"
//-----
int main (void);

void WDTInitial(void);
void WDTEnable(unsigned char);
void WDTDisable(void);

//-----
int main (void)
{
    char SIO;

    SIO = Init_W627DHG();
    if (SIO == 0)
    {
        printf("Can not detect Winbond 83627DHG, program
abort.\n");
        return(1);
    }

    WDTInitial();

    WDTEnable(10);

    WDTDisable();

    return 0;
}
//-----
void WDTInitial(void)
{
    unsigned char bBuf;

    bBuf = Get_W627DHG_Reg(0x2D);
    bBuf &= (~0x01);
    Set_W627DHG_Reg(0x2D, bBuf); //Enable WDTO
}
//-----
void WDTEnable(unsigned char NewInterval)
{
    unsigned char bBuf;
```

```

        Set_W627DHG_LD(0x08);
        Set_W627DHG_Reg(0x30, 0x01);                //enable timer

        bBuf = Get_W627DHG_Reg(0xF5);
        bBuf &= (~0x08);
        Set_W627DHG_Reg(0xF5, bBuf);                //count mode is second

        Set_W627DHG_Reg(0xF6, NewInterval);
        //set timer
    }
//-----
void WDTDisable(void)
{
        Set_W627DHG_LD(0x08);
        Set_W627DHG_Reg(0xF6, 0x00);                //clear
watchdog timer
        Set_W627DHG_Reg(0x30, 0x00);                //watchdog
disabled
}
//-----

//-----
//
// THIS CODE AND INFORMATION IS PROVIDED "AS IS" WITHOUT WARRANTY OF ANY
// KIND, EITHER EXPRESSED OR IMPLIED, INCLUDING BUT NOT LIMITED TO THE
// IMPLIED WARRANTIES OF MERCHANTABILITY AND/OR FITNESS FOR A PARTICULAR
// PURPOSE.
//
//-----
#ifndef __W627DHG_H
#define __W627DHG_H                                1
//-----
#define W627DHG_INDEX_PORT                        (W627DHG_BASE)
#define W627DHG_DATA_PORT                          (W627DHG_BASE+1)
//-----
#define W627DHG_REG_LD                              0x07
//-----
#define W627DHG_UNLOCK                              0x87
#define W627DHG_LOCK                                0xAA
//-----
unsigned int Init_W627DHG(void);
void Set_W627DHG_LD( unsigned char);
void Set_W627DHG_Reg( unsigned char, unsigned char);
unsigned char Get_W627DHG_Reg( unsigned char);
//-----
#endif //__W627DHG_H

//-----
//
// THIS CODE AND INFORMATION IS PROVIDED "AS IS" WITHOUT WARRANTY OF ANY
// KIND, EITHER EXPRESSED OR IMPLIED, INCLUDING BUT NOT LIMITED TO THE
// IMPLIED WARRANTIES OF MERCHANTABILITY AND/OR FITNESS FOR A PARTICULAR
// PURPOSE.
//
//-----
#include "W627DHG.H"
#include <dos.h>
//-----
unsigned int W627DHG_BASE;
void Unlock_W627DHG (void);
void Lock_W627DHG (void);
//-----
unsigned int Init_W627DHG(void)
{
        unsigned int result;
        unsigned char ucDid;

        W627DHG_BASE = 0x4E;
        result = W627DHG_BASE;

```

```

ucDid = Get_W627DHG_Reg(0x20);
if (ucDid == 0xA0)
{
    goto Init_Finish;
}
else if (ucDid == 0xB0)
{
    goto Init_Finish;
}
//W83627DHG-P??

W627DHG_BASE = 0x2E;
result = W627DHG_BASE;

ucDid = Get_W627DHG_Reg(0x20);
if (ucDid == 0xA0)
{
    goto Init_Finish;
}
else if (ucDid == 0xB0)
{
    goto Init_Finish;
}
//W83627DHG-P??

W627DHG_BASE = 0x00;
result = W627DHG_BASE;

Init_Finish:
    return (result);
}
//-----
void Unlock_W627DHG (void)
{
    outportb(W627DHG_INDEX_PORT, W627DHG_UNLOCK);
    outportb(W627DHG_INDEX_PORT, W627DHG_UNLOCK);
}
//-----
void Lock_W627DHG (void)
{
    outportb(W627DHG_INDEX_PORT, W627DHG_LOCK);
}
//-----
void Set_W627DHG_LD( unsigned char LD)
{
    Unlock_W627DHG();
    outportb(W627DHG_INDEX_PORT, W627DHG_REG_LD);
    outportb(W627DHG_DATA_PORT, LD);
    Lock_W627DHG();
}
//-----
void Set_W627DHG_Reg( unsigned char REG, unsigned char DATA)
{
    Unlock_W627DHG();
    outportb(W627DHG_INDEX_PORT, REG);
    outportb(W627DHG_DATA_PORT, DATA);
    Lock_W627DHG();
}
//-----
unsigned char Get_W627DHG_Reg(unsigned char REG)
{
    unsigned char Result;
    Unlock_W627DHG();
    outportb(W627DHG_INDEX_PORT, REG);
    Result = inportb(W627DHG_DATA_PORT);
    Lock_W627DHG();
    return Result;
}
//-----

```

This page is intentionally left blank.