

MB884

Socket LGA775 Pentium® 4
Intel® 915G Chipset
Industrial Motherboard

USER'S MANUAL

Version 1.0

Acknowledgments

Award is a registered trademark of Award Software International, Inc.

PS/2 is a trademark of International Business Machines Corporation.

Intel and Pentium 4 are registered trademarks of Intel Corporation.

Microsoft Windows is a registered trademark of Microsoft Corporation.

Winbond is a registered trademark of Winbond Electronics Corporation.

All other product names or trademarks are properties of their respective owners.

Table of Contents

Introduction	1
Checklist.....	1
Product Description.....	2
MB884 Specifications.....	3
Board Dimensions.....	4
Installations	5
Installing the CPU.....	6
ATX Power Installation.....	7
Installing the Memory.....	7
Setting the Jumpers.....	8
Connectors on MB884.....	12
Watchdog Timer Configuration.....	24
Digital I/O Sample Code.....	27
BIOS Setup	30
Drivers Installation	53
Intel 915G Chipset Software Intallation Utility.....	54
Intel 915G Chipset Graphics Driver.....	55
Realtek AC97 Codec Audio Driver Installation.....	56
Marvell 88E8053 LAN Drivers Installation.....	57
Appendix	59
A. I/O Port Address Map.....	59
B. Interrupt Request Lines (IRQ).....	60

This page is intentionally left blank.

Introduction

Checklist

Your MB884 Pentium® 4 motherboard package should include the items listed below:

- The MB884 motherboard
- This User's Manual
- 1 Back I/O shield
- 1 IDE Cable
- 1 Floppy Cable
- 1 SATA Cable
- Optional 3 SATA Cables
- Optional Serial Port Cable
- 1 CD containing the following:
 - Chipset Drivers
 - Flash Memory Utility

Product Description

The MB884 LGA 775 Pentium® 4 motherboard incorporates the Intel 915G chipset that can utilize a single LGA775 processor of up to 4.0GHz or higher and supports FSB frequency of 533/800Mhz (133MHz, and 200MHz HCLK respectively).

The 915G chipset is designed for use with the Pentium® 4 processor with 1M Level 2 (CPU integrated) cache. The integrated MCH component provides the CPU interface, DDR interface, Hub Interface and PCI Express graphics interface.

Two DDR memory sockets supports DDR 400/333 SDRAM DIMM modules of up to 2GB in capacity.

The board is designed with two Marvell 88E8053 PCI Express Gigabit LAN single controllers. Four Serial ATA connectors offer 1.5 Gigabits/sec data throughput speed - faster than the most advanced parallel ATA.

Expansion is provided by two PCI, one PCI Express x1 slots and one PCI Express x16 slots. Other advanced features include six USB 2.0 ports, IrDA interface, digital I/O, two serial ports, watchdog timer and audio function. Dimensions of the board are 9.5” by 9.5” (244mm x 244mm) in a Micro ATX form factor.

MB884 Specifications

Form Factor	Micro ATX
CPU Type	Intel Pentium 4
CPU Voltage	0.8375V~1.6V (VRD 10.1)
CPU FSB	800MHz
CPU FSB	Up to 3.8+ GHz
Green / APM	APM1.2
CPU Socket	Socket 775
Chipset	Intel® 915GV/915G Chipset GMCH: 915GV/915G 1210-ball FCBGA ICH6: 82801FB 609-ball mBGA; FWH
BIOS	Award BIOS, supports ACPI Function
Cache	1M Level 2 (CPU integrated)
VGA	915GV built-in, supports CRT
Gigabit LAN	Marvell 88E8053 PCI-Express Gigabit LAN controller x2
Audio	ICH6 Built-in Audio controller + AC97 Codec ALC658 6 Channels (Line-out, Line-in & Mic.)
Memory	2x DDR333/400 SDRAM DIMMs (w/o ECC), Max. 2GB (Dual Channel)
Parallel IDE	ICH6 built-in one channel Ultra DMA 33/66/100
Serial ATA Ports	ICH6 built-in Serial ATA Controller, supports 4 ports
USB	ICH6 built-in USB Version 2.0, supports 8 ports, implement 6 ports
LPC I/O	Winbond W83627HF: IrDA x1, Parallel x1, COM1 (RS232), COM2 (RS232/422/485), FDC 2.88MB (3-Mode supported), Hardware monitor (3 thermal inputs, 4 voltage monitor inputs, VID0-4 & 3 fan headers)
RTC	ICH6 built-in w/ on board Lithium Battery
Edge Connector	- PS/2 Keyboard & Mouse, Quad USB stack connector x1 for USB1~4, RJ45 connector (w/ Gigabit transformer) x2 for LAN, DB15 x1 for VGA (CRT), DB9 x1 for COM1, DB26 x1 for Printer, Audio Din stack connector x1 for Line-out, Line-in & Mic
Onboard Header / Connector	- 5x2 pins box-header x1 for COM2 - 4x2 pins pin-header x1 for USB 5~6 - 20x2 pins (2.5mm pitch) box-header x1 for IDE1 - 17x2 pin box-header x 1 for Floppy - 5 pins pin-header x1 for IrDA - 10x2 pins pin-header x1 for other features (PWR LED, Reset, Lock, HDD LED, SPKR, etc.)
Expansion Slots	- PCI x2, PCI Express (x1) x1, PCI Express (x16) x1
Power Connector	ATX 12V (24 pins + 4 pins)
Watchdog Timer	Yes (256 segments, 0, 1, 2...255 sec/min)
System Voltage	+5V, +3.3V, +12V, -12V, 5VSB (2A)
Other Function	Modem Wakeup & LAN Wakeup
Board Size	244mm x 244mm

Board Dimensions

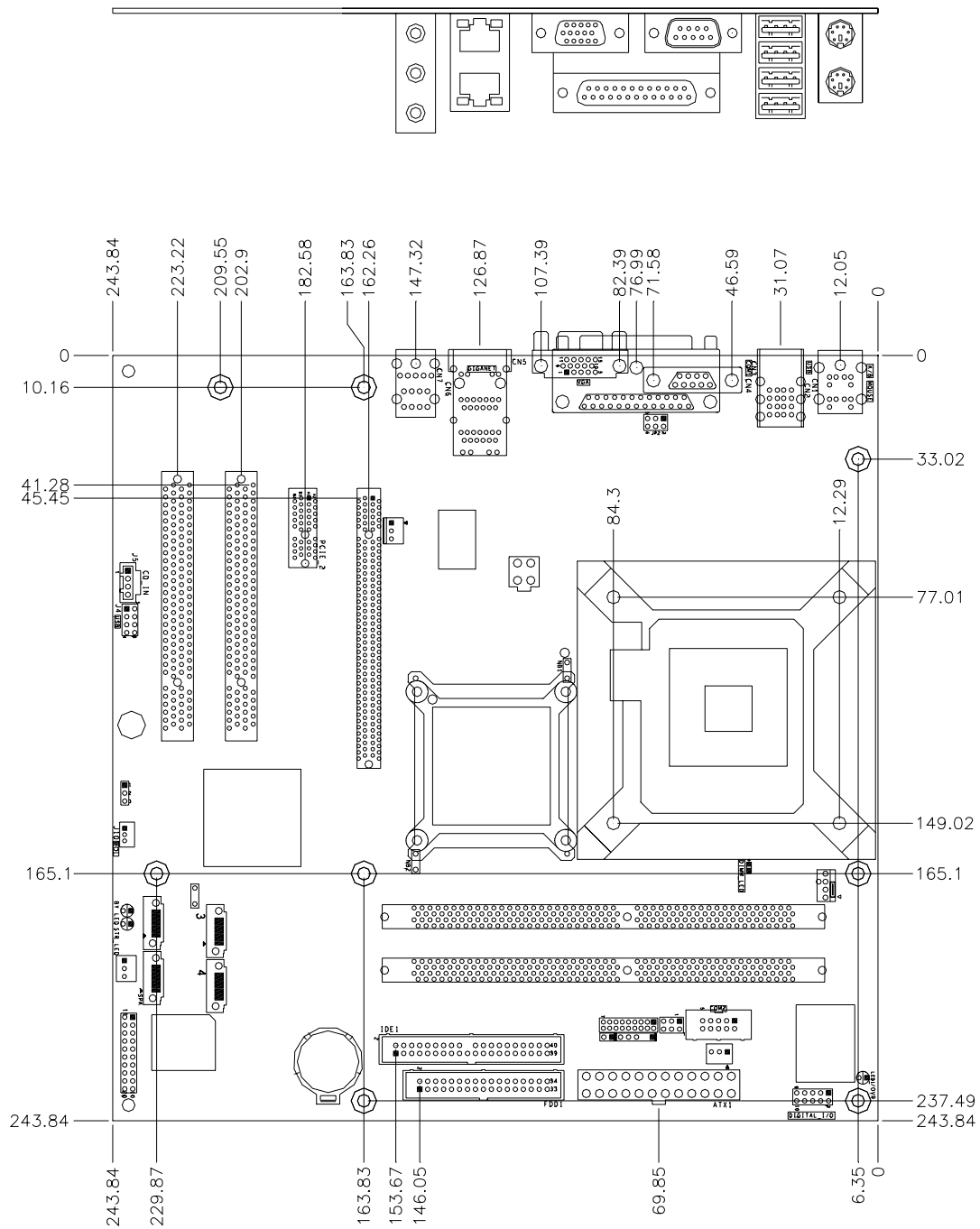

Installations

This section provides information on how to use the jumpers and connectors on the MB884 in order to set up a workable system. The topics covered are:

Installing the CPU	6
ATX Power Installation.....	7
Installing the Memory	7
Setting the Jumpers.....	8
Connectors on MB884.....	12
Watchdog Timer Configuration	24
Digital I/O Sample Code	27

Installing the CPU

The MB884 motherboard supports an LGA 775 processor socket for Intel® Pentium® 4 processors.

The LGA 775 processor socket comes with a lever to secure the processor. Refer to the pictures below, from left to right, on how to place the processor into the CPU socket. ***Please note that the cover of the LGA775 socket must always be installed during transport to avoid damage to the socket.***

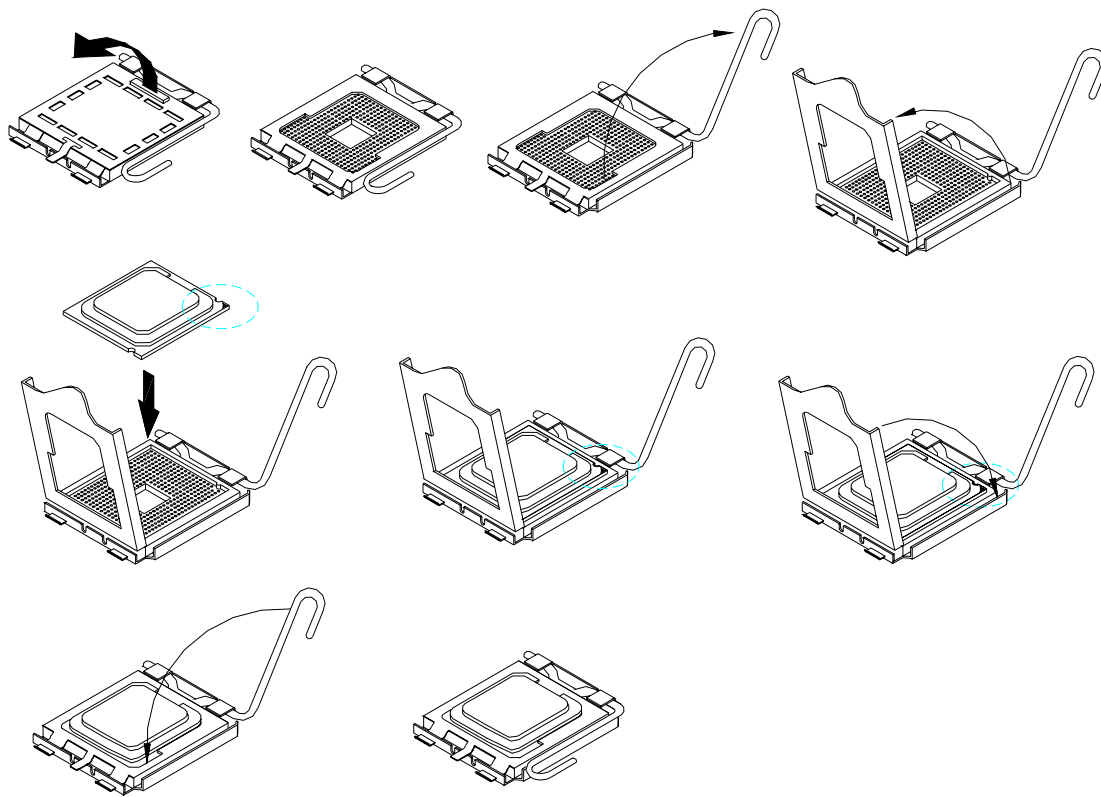

ATX Power Installation

The system power is provided to the motherboard with the ATX1 and ATX_12V power connectors. ATX1 is a 24-pin power connector and ATX_12V is a 4-pin 12V power connector.

The 24-pin power connector can to be connected to a standard 20-pin ATX power connector in a standard ATX power supply (Min. 400watt).

Note: The power supply 5VSB voltage must be at least 2A.

Installing the Memory

The MB884 motherboard supports two DDR memory sockets for a maximum total memory of 2GB in DDR memory type. It supports DDR333 when installed with CPUs that have clock speeds of 533MHz. It supports DDR400 when installed with CPUs that have clock speeds of 800MHz. The board provides dual channel functionality for its DIMM slots. DIMM1 is for one channel and DIMM2 is for another channel.

Basically, the system memory interface has the following features:

- Supports two 64-bit wide DDR data channels

- Available bandwidth up to 3.2GB/s (DDR400) for single-channel mode and 6.4GB/s (DDR400) in dual-channel mode.

- Supports 128Mb, 256Mb, 512Mb, 1Gb DDR technologies.

- Supports only x8, x16, DDR devices with four banks

- Registered DIMMs not supported

- Supports opportunistic refresh

- Up to 16 simultaneously open pages (four per row, four rows maximum)

Setting the Jumpers

Jumpers are used on MB884 to select various settings and features according to your needs and applications. Contact your supplier if you have doubts about the best configuration for your needs. The following lists the connectors on MB884 and their respective functions.

Jumper Locations on MB884	9
JP1: COM2 RS232 +5V/+12V Power Setting	10
JP2: COM1 RS232 +5V/+12V Power Setting	10
JP3: RS232/422/485 (COM2) Selection	10
JP5: Clear CMOS Contents.....	11

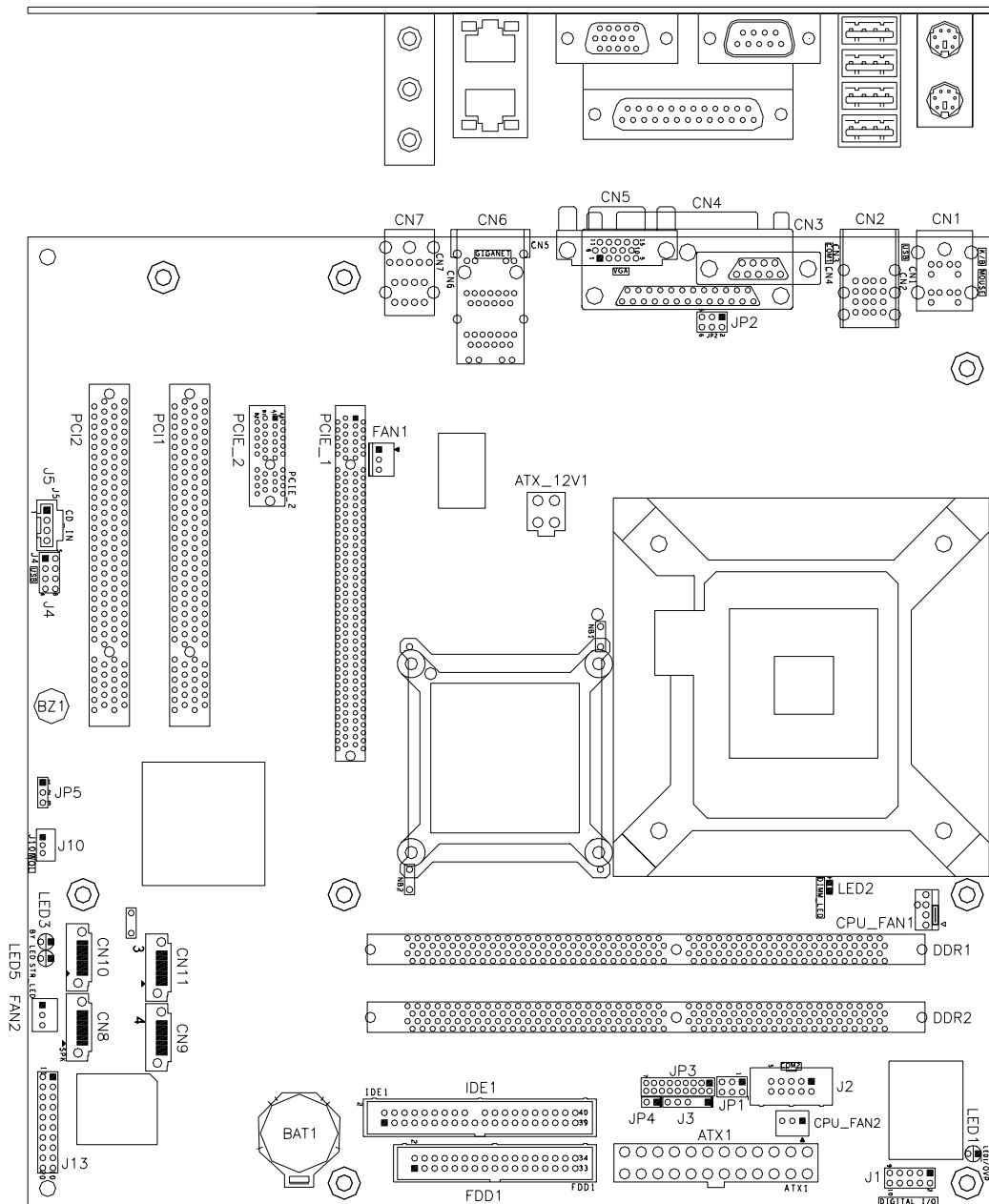

Jumper Locations on MB884

Jumper Locations on MB884	Page
JP1: COM2 RS232 +5V/+12V Power Setting	10
JP2: COM1 RS232 +5V/+12V Power Setting	10
JP3: RS232/422/485 (COM2) Selection	10
JP5: Clear CMOS Contents.....	11

JP1: COM2 RS232 +5V/+12V Power Setting

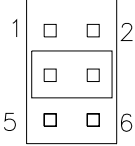
JP1	Setting	Function
	Pin 1-2 Short/Closed	+12V
	Pin 3-4 Short/Closed	Normal
	Pin 5-6 Short/Closed	+5V

JP2: COM1 RS232 +5V/+12V Power Setting

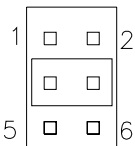
JP2	Setting	Function
	Pin 1-2 Short/Closed	+12V
	Pin 3-4 Short/Closed	Normal
	Pin 5-6 Short/Closed	+5V

JP3: RS232/422/485 (COM2) Selection

COM1 is fixed for RS-232 use only.

JP3, COM2 is selectable for RS232, RS-422 and RS-485.

The following table describes the jumper settings for COM2 selection.

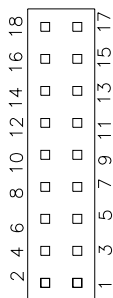

COM2 Function	RS-232	RS-422	RS-485
Jumper Setting (pin closed)	Short: 1-2 9-11 10-12 15-17 16-18	Short: 3-4 7-9 8-10 13-15 14-16	Short: 5-6 7-9 8-10 13-15 14-16

JP5: Clear CMOS Contents

Use JP5, a 3-pin header, to clear the CMOS contents. *Note that the ATX-power connector should be disconnected from the motherboard before clearing CMOS.*

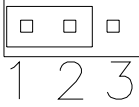
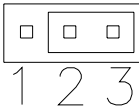
JP5	Setting	Function
 1 2 3	Pin 1-2 Short/Closed	Normal
 1 2 3	Pin 2-3 Short/Closed	Clear CMOS

Connectors on MB884

The connectors on MB884 allows you to connect external devices such as keyboard, floppy disk drives, hard disk drives, printers, etc. The following table lists the connectors on MB884 and their respective functions.

Connector Locations on MB884	13
ATX1: ATX Power Supply Connector	14
ATX_12V: ATX 12V Power Connector	14
DIMM1: Channel A DDR Socket	14
DIMM2: Channel B DDR Socket	14
PCIE_2: PCI Express (x1) Slot	14
PCI1, PCI2: PCI Slots	14
PCIE_1: PCI Express (x16) Slot	14
CN1: PS/2 Keyboard and PS/2 Mouse Connectors.....	15
CN2: 4-port USB Connector	15
CN3, JP2: COM1/COM2 Serial Ports.....	15
CN4: Parallel Port Connector.....	16
CN5: VGA CRT Connector	17
CN6: DUAL LAN RJ45 Connectors.....	17
CN7: Audio Connector.....	17
CN8, CN9, CN10, CN11: SATA Connectors	17
J1: Digital I/O Connector (4 in, 4 out)	18
J3: IrDA Connector	18
J4: USB Connector.....	18
J5: CD-In Audio Connector	18
J10: Wake On LAN Connector	19
J13: System Function Connector.....	19
CPU_FAN1: CPU Fan Power Connector	21
CPU_FAN2: CPU Fan Power Connector	21
FAN1, FAN2: System & Chassis Fan Power Connectors	21
FDD1: Floppy Drive Connector.....	22
IDE1: Primary IDE Connectors	22
LED1: LED for CPU Over-Voltage Protection	23
LED3: Power On LED	23
LED5: Power Off LED.....	23

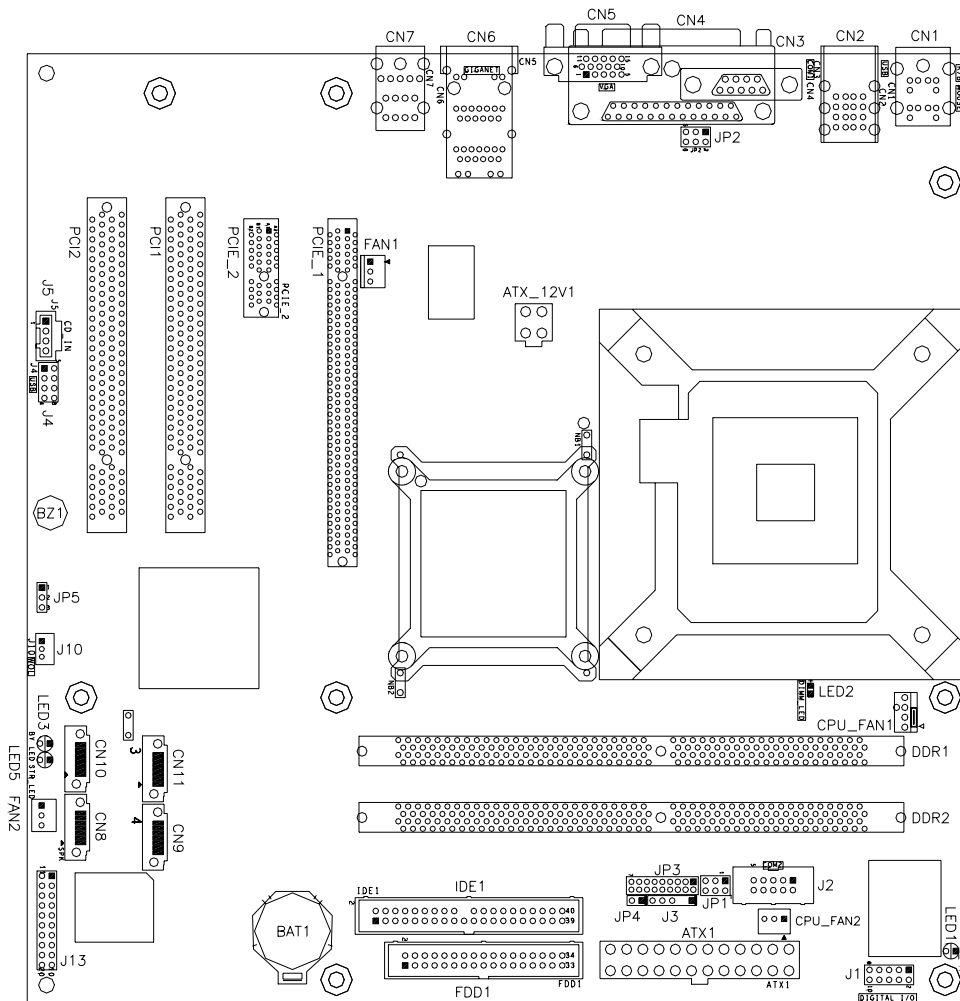

Connectors on MB884	Page
ATX1: ATX Power Supply Connector	14
ATX_12V: ATX 12V Power Connector	14
DIMM1: Channel A DDR Socket.....	14
DIMM2: Channel B DDR Socket.....	14
PCIE_2: PCI Express (x1) Slot.....	14
PCI1, PCI2: PCI Slots.....	14
PCIE_1: PCI Express (x16) Slot.....	14
CN1: PS/2 Keyboard and PS/2 Mouse Connectors	15
CN2: 4-port USB Connector.....	15
CN3, JP2: COM1/COM2 Serial Ports	15
CN4: Parallel Port Connector	16
CN5: VGA CRT Connector.....	17
CN6: DUAL LAN RJ45 Connectors	17
CN7: Audio Connector	17
CN8, CN9, CN10, CN11: SATA Connectors.....	17
J1: Digital I/O Connector (4 in, 4 out).....	18
J3: IrDA Connector.....	18
J4: USB Connector.....	18
J5: CD-In Audio Connector	18
J10: Wake On LAN Connector	19
J13: System Function Connector	19
CPU_FAN1: CPU Fan Power Connector.....	21
CPU_FAN2: CPU Fan Power Connector.....	21
FAN1, FAN2: System & Chassis Fan Power Connectors	21
FDD1: Floppy Drive Connector	22
IDE1: Primary IDE Connectors	22
LED1: LED for CPU Over-Voltage Protection	23
LED3: Power On LED.....	23
LED5: Power Off LED	23

ATX1: ATX Power Supply Connector

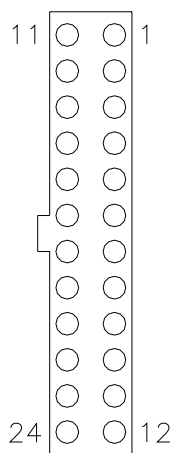

Signal Name	Pin #	Pin #	Signal Name
3.3V	13	1	3.3V
-12V	14	2	3.3V
Ground	15	3	Ground
PS-ON	16	4	+5V
Ground	17	5	Ground
Ground	18	6	+5V
Ground	19	7	Ground
-5V	20	8	Power good
+5V	21	9	5VSB
+5V	22	10	+12V
+5V	23	11	+12V
Ground	24	12	+3.3V

ATX1 is a 24-pin ATX power supply connector.

ATX_12V: ATX 12V Power Connector

This connector supplies the CPU operation voltage

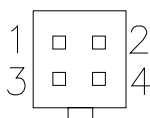

Pin #	Signal Name
1	Ground
2	Ground
3	+12V
4	+12V

DIMM1: Channel A DDR Socket

DIMM1 is the first-channel DDR socket.

DIMM2: Channel B DDR Socket

DIMM2 is the second-channel DDR socket.

PCIE_1: External PCI Express (x16) Graphics Card Slot

PCIE_2: PCI Express (x1) Slot

PCI1, PCI2: PCI Slots

PCIE_1: PCI Express (x16) Slot

CN1: PS/2 Keyboard and PS/2 Mouse Connectors

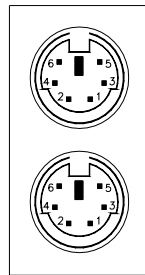

PS/2 Mouse

PS/2 Keyboard

Signal Name	Keyboard	Mouse	Signal Name
Keyboard data	1	1	Mouse data
N.C.	2	2	N.C.
GND	3	3	GND
5V	4	4	5V
Keyboard clock	5	5	Mouse clock
N.C.	6	6	N.C.

CN2: 4-port USB Connector

CN2 is a USB connector consisting of four ports stacked vertically.

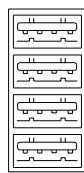

CN2

Pin	Signal Name
1	Ground
2	USB+
3	USB-
4	Vcc

CN3, JP2: COM1/COM2 Serial Ports

CN3 (COM1) is a DB-9 connector, while JP2 is a COM2 pin-header connector.

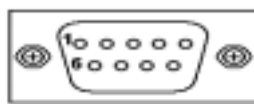

COM1

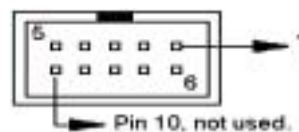

COM2

Signal Name	Pin #	Pin #	Signal Name
DCD, Data carrier detect	1	6	DSR, Data set ready
RXD, Receive data	2	7	RTS, Request to send
TXD, Transmit data	3	8	CTS, Clear to send
DTR, Data terminal ready	4	9	RI, Ring indicator
GND, ground	5	10	Not Used

COM2 is jumper selectable for RS-232, RS-422 and RS-485.

Pin #	Signal Name		
	RS-232	RS-422	RS-485
1	DCD	TX-	DATA-
2	RX	TX+	DATA+
3	TX	RX+	NC
4	DTR	RX-	NC
5	Ground	Ground	Ground
6	DSR	RTS-	NC
7	RTS	RTS+	NC
8	CTS	CTS+	NC
9	RI	CTS-	NC
10	NC	NC	NC

CN4: Parallel Port Connector

CN4 is a DB-25 external connector situated on top of the VGA and serial ports.

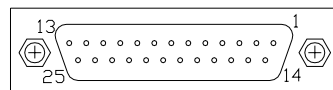

CN4 Parallel Port

Signal Name	Pin #	Pin #	Signal Name
Line printer strobe	1	14	AutoFeed
PD0, parallel data 0	2	15	Error
PD1, parallel data 1	3	16	Initialize
PD2, parallel data 2	4	17	Select
PD3, parallel data 3	5	18	Ground
PD4, parallel data 4	6	19	Ground
PD5, parallel data 5	7	20	Ground
PD6, parallel data 6	8	21	Ground
PD7, parallel data 7	9	22	Ground
ACK, acknowledge	10	23	Ground
Busy	11	24	Ground
Paper empty	12	25	Ground
Select	13	N/A	N/A

CN5: VGA CRT Connector

CN5 is a DB-15 VGA connector located beside the COM1 port. The following table shows the pin-out assignments of this connector.

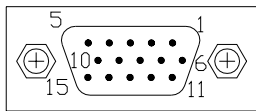

Signal Name	Pin #	Pin #	Signal Name
Red	1	2	Green
Blue	3	4	N.C.
GND	5	6	GND
GND	7	8	GND
N.C.	9	10	GND
N.C.	11	12	N.C.
HSYNC	13	14	VSYNC
NC	15		

CN6: DUAL LAN RJ45 Connectors

CN6 consists of two RJ-45 connectors that are used in conjunction with the Marvell 88E8053 PCI Express Gigabit LAN single controllers.

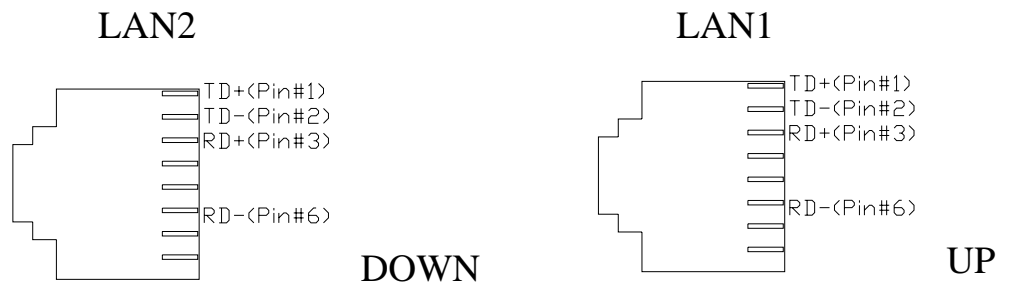

CN7: Audio Connector

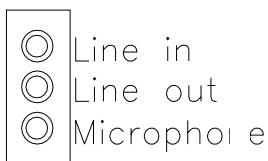

CN7 is a 3-jack audio connector beside the USB/RJ45 combo connector.

CN8, CN9, CN10, CN11: SATA Connectors

The SATA connectors support SATA 150 and use one serial ATA HDD for each. CN8 is port 2, CN9 is port 4, CN10 is port1 and CN11 is port3

J1: Digital I/O Connector (4 in, 4 out)

This 10-pin Digital I/O connector supports TTL levels and is used to control external devices requiring ON/OFF circuitry.

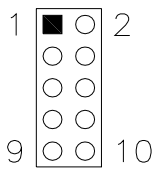

Signal Name	Pin #	Pin #	Signal Name
Ground	1	2	+5V
Out3	3	4	Out1
Out2	5	6	Out0
IN3	7	8	IN1
IN2	9	10	IN0

J3: IrDA Connector

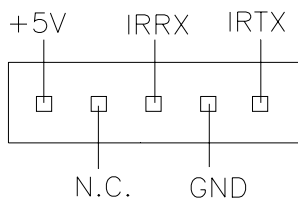

Pin #	Signal Name
1	+5V
2	No connect
3	Ir RX
4	Ground
5	Ir TX

J4: USB Connector

The following table shows the pin outs of the USB pin header.

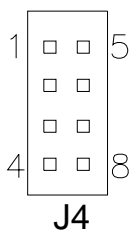

Signal Name	Pin	Pin	Signal Name
Vcc	1	5	Ground
USB0-	2	6	USB1+
USB0+	3	7	USB1-
Ground	4	8	Vcc

J5: CD-In Audio Connector



Pin #	Signal Name
1	CD Audio R
2	Ground
3	Ground
4	CD Audio L

J10: Wake On LAN Connector

J10 is a 3-pin header for the Wake On LAN function on the motherboard. The following table shows the pin out assignments of this connector. Wake On LAN will function properly only with an ATX power supply with 5VSB that has 1A.

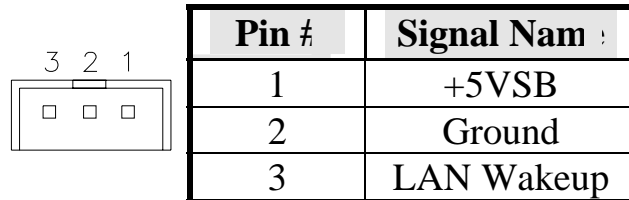

J13: System Function Connector

J13 provides connectors for system indicators that provide light indication of the computer activities and switches to change the computer status.

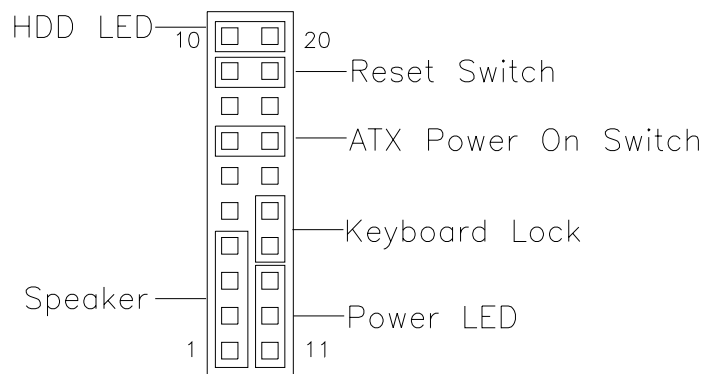

Speaker: Pins 1 - 4

This connector provides an interface to a speaker for audio tone generation. An 8-ohm speaker is recommended.

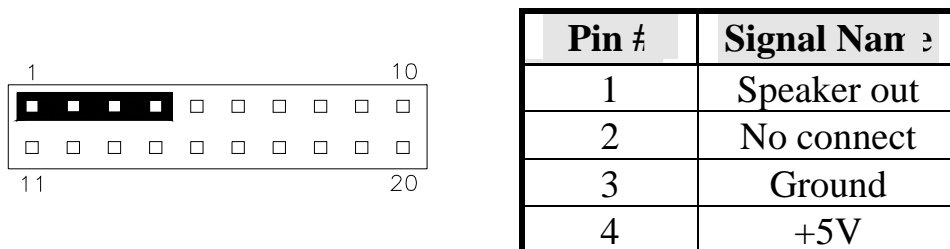

Power LED: Pins 11 - 13

The power LED indicates the status of the main power switch.

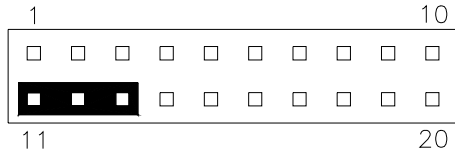

Pin #	Signal Name
11	Power LED
12	No connect
13	Ground

Keyboard Locked: Pin 14-15

To use keyboard lock, set pin14/15 to short/closed

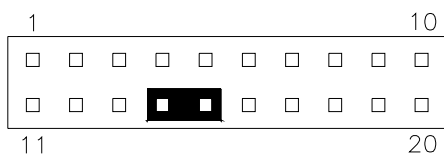

Pin #	Signal Name
14	Keyboard lock
15	Ground

ATX Power ON Switch: Pins 7 and 17

This 2-pin connector is an “ATX Power Supply On/Off Switch” on the system that connects to the power switch on the case. When pressed, the power switch will force the system to power on. When pressed again, it will force the system to power off.

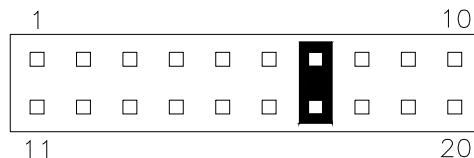

Reset Switch: Pins 9 and 19

The reset switch allows the user to reset the system without turning the main power switch off and then on again. Orientation is not required when making a connection to this header.

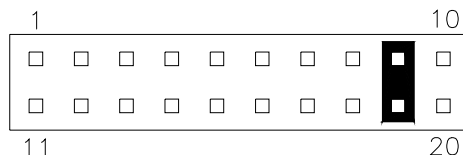

Hard Disk Drive LED Connector: Pins 10 and 20

This connector connects to the hard drive activity LED on control panel. This LED will flash when the HDD is being accessed.

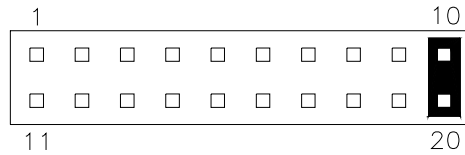

Pin #	Signal Name
10	HDD Active
20	5V

CPU_FAN1: CPU Fan Power Connector

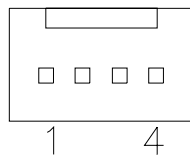

Pin #	Signal Name
1	Ground
2	+12V
3	Rotation detection
4	Control

CPU_FAN2: CPU Fan Power Connector

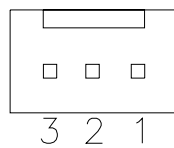

Pin #	Signal Name
1	Ground
2	+12V
3	Rotation detection

FAN1, FAN2: System & Chassis Fan Power Connectors

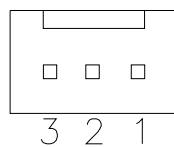

Pin #	Signal Name
1	Ground
2	+12V
3	Rotation detection

FDD1: Floppy Drive Connector

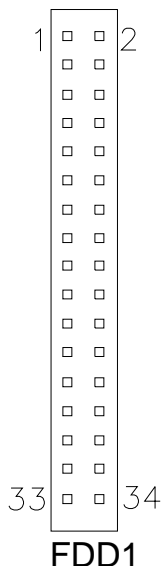

Signal Name	Pin #	Pin #	Signal Name
Ground	1	2	RM/LC
Ground	3	4	No connect
Ground	5	6	No connect
Ground	7	8	Index
Ground	9	10	Motor enable 0
Ground	11	12	Drive select 1
Ground	13	14	Drive select 0
Ground	15	16	Motor enable 1
Ground	17	18	Direction
Ground	19	20	Step
Ground	21	22	Write data
Ground	23	24	Write gate
Ground	25	26	Track 00
Ground	27	28	Write protect
Ground	29	30	Read data
Ground	31	32	Side 1 select
Ground	33	34	Diskette change

IDE1: Primary IDE Connectors

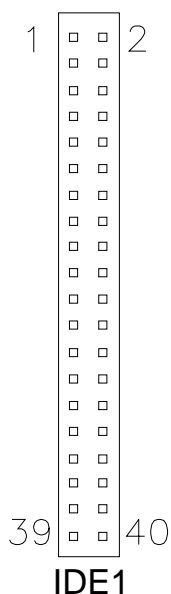

Signal Name	Pin #	Pin #	Signal Name
Reset IDE	1	2	Ground
Host data 7	3	4	Host data 8
Host data 6	5	6	Host data 9
Host data 5	7	8	Host data 10
Host data 4	9	10	Host data 11
Host data 3	11	12	Host data 12
Host data 2	13	14	Host data 13
Host data 1	15	16	Host data 14
Host data 0	17	18	Host data 15
Ground	19	20	Protect pin
DRQ0	21	22	Ground
Host IOW	23	24	Ground
Host IOR	25	26	Ground
IOCHRDY	27	28	Host ALE
DACK0	29	30	Ground
IRQ14	31	32	No connect
Address 1	33	34	No connect
Address 0	35	36	Address 2
Chip select 0	37	38	Chip select 1
Activity	39	40	Ground

LED1: LED for CPU Over-Voltage Protection

This red LED shall light to indicate that the CPU voltage has surged and reached the default voltage protection value (2V). In such a case, the system will shut down automatically.

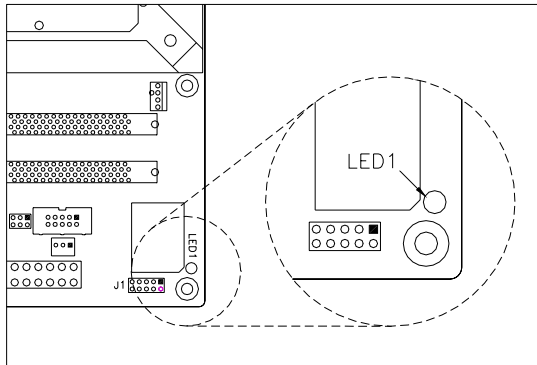
**LED3: Power On LED**

This green LED will light constantly when the power is on to indicate that the 5VSB status has switched to 5V power.

LED5: Power Off LED

This Red LED will light constantly during a power-off status to indicate 5VSB status. At this time, LED3 will not light.

Watchdog Timer Configuration

The WDT is used to generate a variety of output signals after a user programmable count. The WDT is suitable for use in the prevention of system lock-up, such as when software becomes trapped in a deadlock. Under these sort of circumstances, the timer will count to zero and the selected outputs will be driven. Under normal circumstance, the user will restart the WDT at regular intervals before the timer counts to zero.

SAMPLE CODE:

This code and information is provided "as is" without warranty of any kind, either expressed or implied, including but not limited to the implied warranties of merchantability and/or fitness for a particular purpose.

```

;[]=====
; Name   : Enable_And_Set_Watchdog
; IN    : AL - 1sec ~ 255sec
; OUT   : None
;[]=====
Enable_And_Set_Watchdog Proc Near
    push ax                ;save time interval
    call Unlock_Chip

    mov cl, 2Bh
    call Read_Reg
    and al, NOT 10h
    call Write_Reg        ;set GP24 as WDTO

    mov cl, 07h
    mov al, 08h
    call Write_Reg        ;switch to LD8

    mov cl, 0F5h
    call Read_Reg
    and al, NOT 08h
    call Write_Reg        ;set count mode as second

    pop ax
    mov cl, 0F6h
    call Write_Reg        ;set watchdog timer

```

```

        mov al, 01h
        mov cl, 30h
        call Write_Reg      ;watchdog enabled

        call Lock_Chip
        ret
Enable_And_Set_Watchdog Endp
;[]=====
; Name   : Disable_Watchdog
; IN    : None
; OUT   : None
;[]=====
Disable_Watchdog Proc Near
        call Unlock_Chip

        mov cl, 07h
        mov al, 08h
        call Write_Reg      ;switch to LD8

        xor al, al
        mov cl, 0F6h
        call Write_Reg      ;clear watchdog timer

        xor al, al
        mov cl, 30h
        call Write_Reg      ;watchdog disabled

        call Lock_Chip
        ret
Disable_Watchdog Endp
;[]=====
; Name   : Unlock_Chip
; IN    : None
; OUT   : None
;[]=====
Unlock_Chip Proc Near
        Mov dx, 4Eh
        mov al, 87h
        out dx, al
        out dx, al
        ret
Unlock_Chip Endp
;[]=====
; Name   : Lock_Chip
; IN    : None
; OUT   : None

```

```
;[]=====
Unlock_Chip Proc Near
    mov dx, 4Eh
    mov al, 0AAh
    out dx, al
    ret
Unlock_Chip Endp
;[]=====
; Name : Write_Reg
; IN : CL - register index
; AL - Value to write
; OUT : None
;[]=====
Write_RegProc Near
    push ax
    mov dx, 4Eh
    mov al, cl
    out dx, al
    pop ax
    inc dx
    out dx, al
    ret
Write_RegEndp
;[]=====
; Name : Read_Reg
; IN : CL - register index
; OUT : AL - Value to read
;[]=====
Read_Reg Proc Near
    Mov al, cl
    mov dx, 4Eh
    out dx, al
    inc dx
    in al, dx
    ret
Read_Reg Endp
;[]=====
```

Digital I/O Sample Code

Filename: W627hf.h

```
//=====
//
// THIS CODE AND INFORMATION IS PROVIDED "AS IS" WITHOUT WARRANTY OF ANY
// KIND, EITHER EXPRESSED OR IMPLIED, INCLUDING BUT NOT LIMITED TO THE
// IMPLIED WARRANTIES OF MERCHANTABILITY AND/OR FITNESS FOR A PARTICULAR
// PURPOSE.
//
//=====
#ifndef __W627HF_H
#define __W627HF_H                1
//=====
#define W627_IOBASE                0x4E
//=====
#define W627HF_INDEX_PORT          (W627_IOBASE+0)
#define W627HF_DATA_PORT          (W627_IOBASE+1)
//=====
#define W627HF_REG_LD              0x07
//=====
#define W627HF_UNLOCK              0x87
#define W627HF_LOCK                0xAA
//=====
void Set_W627HF_LD( unsigned char);
void Set_W627HF_Reg( unsigned char, unsigned char);
unsigned char Get_W627HF_Reg( unsigned char);
//=====
#endif    //__W627HF_H
```

INSTALLATIONS

Filename: W627hf.cpp

```
//=====
//
// THIS CODE AND INFORMATION IS PROVIDED "AS IS" WITHOUT WARRANTY OF ANY
// KIND, EITHER EXPRESSED OR IMPLIED, INCLUDING BUT NOT LIMITED TO THE
// IMPLIED WARRANTIES OF MERCHANTABILITY AND/OR FITNESS FOR A PARTICULAR
// PURPOSE.
//
//=====
#include "W627HF.H"
#include <dos.h>
//=====
void Unlock_W627HF (void);
void Lock_W627HF (void);
//=====
void Unlock_W627HF (void)
{
    outportb(W627HF_INDEX_PORT, W627HF_UNLOCK);
    outportb(W627HF_INDEX_PORT, W627HF_UNLOCK);
}
//=====
void Lock_W627HF (void)
{
    outportb(W627HF_INDEX_PORT, W627HF_LOCK);
}
//=====
void Set_W627HF_LD( unsigned char LD)
{
    Unlock_W627HF();
    outportb(W627HF_INDEX_PORT, W627HF_REG_LD);
    outportb(W627HF_DATA_PORT, LD);
    Lock_W627HF();
}
//=====
void Set_W627HF_Reg( unsigned char REG, unsigned char DATA)
{
    Unlock_W627HF();
    outportb(W627HF_INDEX_PORT, REG);
    outportb(W627HF_DATA_PORT, DATA);
    Lock_W627HF();
}
//=====
unsigned char Get_W627HF_Reg( unsigned char REG)
{
    unsigned char Result;
    Unlock_W627HF();
    outportb(W627HF_INDEX_PORT, REG);
    Result = inportb(W627HF_DATA_PORT);
    Lock_W627HF();
    return Result;
}
//=====
File of the Main.cpp
```

```

//=====
//
// THIS CODE AND INFORMATION IS PROVIDED "AS IS" WITHOUT WARRANTY OF ANY
// KIND, EITHER EXPRESSED OR IMPLIED, INCLUDING BUT NOT LIMITED TO THE
// IMPLIED WARRANTIES OF MERCHANTABILITY AND/OR FITNESS FOR A PARTICULAR
// PURPOSE.
//
//=====
#include <dos.h>
#include <conio.h>
#include <stdio.h>
#include <stdlib.h>
#include "W627HF.H"
//=====
void ClrKbBuf(void);
int main (int argc, char *argv[]);
//=====
int main (int argc, char *argv[])
{
    unsigned char ucDO = 0;                //data for digital output
    unsigned char ucDI;                    //data for digital input
    unsigned char ucBuf;

    Set_W627HF_LD( 0x07);                  //switch to logic device 7

    Set_W627HF_Reg(0xF1, 0x00);            //clear
    ucDI = Get_W627HF_Reg(0xF1) & 0x0F;

    ClrKbBuf();
    while(1)
    {
        ucDO++;
        Set_W627HF_Reg(0xF1, ((ucDO & 0x0F) << 4));
        ucBuf = Get_W627HF_Reg(0xF1) & 0x0F;
        if (ucBuf != ucDI)
        {
            ucDI = ucBuf;
            printf("Digital I/O Input Changed. Current Data is 0x%X\n",ucDI);
        }

        if (kbhit())
        {
            getch();
            break;
        }
        delay(500);
    }
    return 0;
}
//=====
void ClrKbBuf(void)
{
    while(kbhit())
    {    getch();    }
}
//-----

```

BIOS Setup

This chapter describes the different settings available in the Award BIOS that comes with the motherboard. The topics covered in this chapter are as follows:

BIOS Introduction	31
BIOS Setup.....	31
Standard CMOS Setup	33
Advanced BIOS Features	36
Advanced Chipset Features	40
Integrated Peripherals.....	43
Power Management Setup.....	47
PNP/PCI Configurations	49
PC Health Status.....	50
Frequency/Voltage Control	51
Load Fail-Safe Defaults	52
Load Setup Defaults	52
Set Supervisor/User Password.....	52
Save & Exit Setup	52
Exit Without Saving	52

BIOS Introduction

The Award BIOS (Basic Input/Output System) installed in your computer system's ROM supports Intel® Pentium® 4 processors. The BIOS provides critical low-level support for a standard device such as disk drives, serial ports and parallel ports. It also adds virus and password protection as well as special support for detailed fine-tuning of the chipset controlling the entire system.

BIOS Setup

The Award BIOS provides a Setup utility program for specifying the system configurations and settings. The BIOS ROM of the system stores the Setup utility. When you turn on the computer, the Award BIOS is immediately activated. Pressing the key immediately allows you to enter the Setup utility. If you are a little bit late pressing the key, POST (Power On Self Test) will continue with its test routines, thus preventing you from invoking the Setup. If you still wish to enter Setup, restart the system by pressing the "Reset" button or simultaneously pressing the <Ctrl>, <Alt> and <Delete> keys. You can also restart by turning the system Off and back On again. The following message will appear on the screen:

Press to Enter Setup

In general, you press the arrow keys to highlight items, <Enter> to select, the <PgUp> and <PgDn> keys to change entries, <F1> for help and <Esc> to quit.

When you enter the Setup utility, the Main Menu screen will appear on the screen. The Main Menu allows you to select from various setup functions and exit choices.

Phoenix - AwardBIOS CMOS Setup Utility

Standard CMOS Features	Frequency/Voltage Control
Advanced BIOS Features	Load Fail-Safe Defaults
Advanced Chipset Features	Load Optimized Defaults
Integrated Peripherals	Set Supervisor Password
Power Management Setup	Set User Password
PnP/PCI Configurations	Save & Exit Setup
PC Health Status	Exit Without Saving
ESC : Quit	↑ ↓ → ← : Select Item
F10 : Save & Exit Setup	
Time, Date, Hard Disk Type...	

The section below the setup items of the Main Menu displays the control keys for this menu. At the bottom of the Main Menu just below the control keys section, there is another section, which displays information on the currently highlighted item in the list.

Note: *If the system cannot boot after making and saving system changes with Setup, the Award BIOS supports an override to the CMOS settings that resets your system to its default.*

Warning: *It is strongly recommended that you avoid making any changes to the chipset defaults. These defaults have been carefully chosen by both Award and your system manufacturer to provide the absolute maximum performance and reliability. Changing the defaults could cause the system to become unstable and crash in some cases.*

Standard CMOS Setup

“Standard CMOS Setup” choice allows you to record some basic hardware configurations in your computer system and set the system clock and error handling. If the board is already installed in a working system, you will not need to select this option. You will need to run the Standard CMOS option, however, if you change your system hardware configurations, the onboard battery fails, or the configuration stored in the CMOS memory was lost or damaged.

Phoenix - AwardBIOS CMOS Setup Utility
Standard CMOS Features

Date (mm:dd:yy)	Thu, Dec 16, 2004	Item Help
Time (hh:mm:ss)	00 : 00 : 00	Menu Level
IDE Channel 0 Master	None	Change the day, month, Year and century
IDE Channel 0 Slave	None	
IDE Channel 1 Master	None	
IDE Channel 1 Slave	None	
Drive A	1.44M, 3.5 in.	
Drive B	None	
Video	EGA/VGA	
Halt On	All Errors , But Keyboard	
Base Memory	640K	
Extended Memory	515072K	
Total Memory	516096K	

At the bottom of the menu are the control keys for use on this menu. If you need any help in each item field, you can press the <F1> key. It will display the relevant information to help you. The memory display at the lower right-hand side of the menu is read-only. It will adjust automatically according to the memory changed. The following describes each item of this menu.

Date

The date format is:

Day : Sun to Sat
Month : 1 to 12
Date : 1 to 31
Year : 1999 to 2099

To set the date, highlight the “Date” field and use the PageUp/ PageDown or +/- keys to set the current time.

Time

The time format is: **Hour** : 00 to 23
 Minute : 00 to 59
 Second : 00 to 59

To set the time, highlight the “Time” field and use the <PgUp>/ <PgDn> or +/- keys to set the current time.

IDE Primary HDDs / IDE Secondary HDDs

The onboard PCI IDE connectors provide Primary and Secondary channels for connecting up to four IDE hard disks or other IDE devices. Each channel can support up to two hard disks; the first is the “Master” and the second is the “Slave”.

Press <Enter> to configure the hard disk. The selections include Auto, Manual, and None. Select ‘Manual’ to define the drive information manually. You will be asked to enter the following items.

Capacity : Capacity/size of the hard disk drive
Cylinder : Number of cylinders
Head : Number of read/write heads
Precomp : Write precompensation
Landing Zone : Landing zone
Sector : Number of sectors

The Access Mode selections are as follows:

CHS (HD < 528MB)
LBA (HD > 528MB and supports Logical Block Addressing)
Large (for MS-DOS only)
Auto

Drive A / Drive B

These fields identify the types of floppy disk drive A or drive B that has been installed in the computer. The available specifications are:

360KB	1.2MB	720KB	1.44MB	2.88MB
5.25 in.	5.25 in.	3.5 in.	3.5 in.	3.5 in.

Video

This field selects the type of video display card installed in your system. You can choose the following video display cards:

EGA/VGA	For EGA, VGA, SEGA, SVGA or VGA monitor adapters. (default)
CGA 40	Power up in 40 column mode.
CGA 80	Power up in 80 column mode.
MONO	For Hercules or MDA adapters.

Halt On

This field determines whether or not the system will halt if an error is detected during power up.

No errors	The system boot will not be halted for any error that may be detected.
All errors	Whenever the BIOS detects a non-fatal error, the system will stop and you will be prompted.
All, But Keyboard	The system boot will not be halted for a keyboard error; it will stop for all other errors
All, But Diskette	The system boot will not be halted for a disk error; it will stop for all other errors.
All, But Disk/Key	The system boot will not be halted for a keyboard or disk error; it will stop for all others.

Advanced BIOS Features

This section allows you to configure and improve your system and allows you to set up some system features according to your preference.

Phoenix - AwardBIOS CMOS Setup Utility
Advanced BIOS Features

CPU Feature	Press Enter	ITEM HELP
Hard Disk Boot Priority	Press Enter	
Virus Warning	Disabled	Menu Level
CPU L1 and L2 Cache	Enabled	
Hyper-Threading Technology	Enabled	
Quick Power On Self Test	Enabled	
First Boot Device	Floppy	
Second Boot Device	Hard Disk	
Third Boot Device	CDROM	
Boot Other Device	Enabled	
Swap Floppy Drive	Disabled	
Boot Up Floppy Seek	Disabled	
Boot Up Numlock Status	On	
Gate A20 Option	Fast	
Typematic Rate Setting	Disabled	
Typematic Rate (chars/Sec)	6	
Typematic Delay (Msec)	250	
Security Option	Setup	
APIC Mode	Enabled	
MPS Version Control for OS	1.4	
OS Select For DRAM>64MB	Non-OS2	
Report No FDD For WIN 95	Yes	
Small Logo (EPA) Show	Enabled	

Phoenix - AwardBIOS CMOS Setup Utility
CPU Features

Delay Prior Thermal	16 Min	ITEM HELP
Thermal Management	Thermal Monitor 1	
Limit CPUID MaxVal	Disabled	Menu Level

Delay Prior to Thermal

This field activates the CPU thermal function after the systems boots for the set number of minutes. The options are *16Min* and *64Min*.

Limit CPUID MaxVal

The choices are:

Enabled: Limits CPUID maximum value to 3 when used with older OS like Windows NT4.

Disabled: Disables CPUID limit for Windows XP.

Hard Disk Boot Priority

This item allows you to set the priority for hard disk boot. When you press enter, the selections shows the current hard disks used in your system as well as the “Bootable Add-in Card” that is relevant to other boot sources media such as SCSI cards and LAN cards.

Virus Warning

This item protects the boot sector and partition table of your hard disk against accidental modifications. If an attempt is made, the BIOS will halt the system and display a warning message. If this occurs, you can either allow the operation to continue or run an anti-virus program to locate and remove the problem.

CPU L1 and L2 Cache

Cache memory is additional memory that is much faster than conventional DRAM (system memory). CPUs from 486-type on up contain internal cache memory, and most, but not all, modern PCs have additional (external) cache memory. When the CPU requests data, the system transfers the requested data from the main DRAM into cache memory, for even faster access by the CPU. These items allow you to enable (speed up memory access) or disable the cache function..

Hyper-Threading Technology

Hyper-Threading Technology enables two logical processors on a single physical processor by replicating, partitioning, and sharing the resources within the Intel NetBurst microarchitecture pipeline.

Quick Power On Self Test

When enabled, this field speeds up the Power On Self Test (POST) after the system is turned on. If it is set to *Enabled*, BIOS will skip some items.

First/Second/Third Boot Device

These fields determine the drive that the system searches first for an operating system. The options available include *Floppy*, *LS/ZIP*, *Hard Disk*, *CDROM*, *LAN*, *USB-FDD*, *USB-ZIP*, *USB-CDROM* and *Disable*.

Boot Other Device

These fields allow the system to search for an operating system from other devices other than the ones selected in the First/Second/Third Boot Device.

Swap Floppy Drive

This item allows you to determine whether or not to enable Swap Floppy Drive. When enabled, the BIOS swaps floppy drive assignments so that Drive A becomes Drive B, and Drive B becomes Drive A. By default, this field is set to *Disabled*.

Boot Up Floppy Seek

This feature controls whether the BIOS checks for a floppy drive while booting up. If it cannot detect one (either due to improper configuration or its absence), it will flash an error message.

Boot Up NumLock Status

This allows you to activate the NumLock function after you power up the system.

Gate A20 Option

This field allows you to select how Gate A20 is worked. Gate A20 is a device used to address memory above 1 MB.

Typematic Rate Setting

When disabled, continually holding down a key on your keyboard will generate only one instance. When enabled, you can set the two typematic controls listed next. By default, this field is set to *Disabled*.

Typematic Rate (Chars/Sec)

When the typematic rate is enabled, the system registers repeated keystrokes speeds. Settings are from 6 to 30 characters per second.

Typematic Delay (Msec)

When the typematic rate is enabled, this item allows you to set the time interval for displaying the first and second characters. By default, this item is set to *250msec*.

Security Option

This field allows you to limit access to the System and Setup. The default value is *Setup*. When you select *System*, the system prompts for the User Password every time you boot up. When you select *Setup*, the system always boots up and prompts for the Supervisor Password only when the Setup utility is called up.

APIC Mode

APIC stands for Advanced Programmable Interrupt Controller. The default setting is *Enabled*.

MPS Version Control for OS

This option specifies the MPS (Multiprocessor Specification) version for your operating system. MPS version 1.4 added extended configuration tables to improve support for multiple PCI bus configurations and improve future expandability. The default setting is *1.4*.

OS Select for DRAM > 64MB

This option allows the system to access greater than 64MB of DRAM memory when used with OS/2 that depends on certain BIOS calls to access memory. The default setting is *Non-OS/2*.

Report No FDD For WIN 95

If you are using Windows 95/98 without a floppy disk drive, select Enabled to release IRQ6. This is required to pass Windows 95/98's SCT test. You should also disable the Onboard FDC Controller in the Integrated Peripherals screen when there's no floppy drive in the system. If you set this feature to Disabled, the BIOS will not report the missing floppy drive to Win95/98.

Small Logo (EPA) Show

The EPA logo appears at the right side of the monitor screen when the system is boot up. The default setting is *Enabled*.

Advanced Chipset Features

This Setup menu controls the configuration of the chipset.

Phoenix - AwardBIOS CMOS Setup Utility
Advanced Chipset Features

DRAM Timing Selectable	By SPD	ITEM HELP
CAS Latency Time	2.5	Menu Level
DRAM RAS# to CAS# Delay	3	
DRAM RAS# Precharge	3	
Precharge dealy (tRAS)	8	
System Memory Frequency	400MHz	
SLP_S4# Assertion Width	1 to 2 Sec.	
System BIOS Cacheable	Enabled	
Video BIOS Cacheable	Enabled	
Memory Hole At 15M-16M	Disabled	
PCI Express Root Port Func	Press Enter	
** VGA Setting **		
PEG/Onchip VGA Control	Auto	
On-Chip Video Memory Size	Press Enter	
On-Chip Frame Buffer Size	8MB	
FIXED Memory Size	0MB	
DVMT Memory Size	120MB	

Phoenix - AwardBIOS CMOS Setup Utility
PCI Express Root Port Func

PCI Express Port 1	Auto	ITEM HELP
PCI Express Port 2	Auto	Menu Level
PCI Express Port 3	Auto	
PCI Express Port 4	Auto	
PCI-E Compliancy Mode	V1.0a	

DRAM Timing Selectable

This option refers to the method by which the DRAM timing is selected. The default is **By SPD**.

CAS Latency Time

You can select CAS latency time in HCLKs of 2/2 or 3/3. The system board designer should set the values in this field, depending on the DRAM installed. Do not change the values in this field unless you change specifications of the installed DRAM or the installed CPU. The choices are 2 and 3.

DRAM RAS# to CAS# Delay

This option allows you to insert a delay between the RAS (Row Address Strobe) and CAS (Column Address Strobe) signals. This delay occurs when the SDRAM is written to, read from or refreshed. Reducing the delay improves the performance of the SDRAM.

DRAM RAS# Precharge

This option sets the number of cycles required for the RAS to accumulate its charge before the SDRAM refreshes. The default setting for the Active to Precharge Delay is 3.

Precharge delay (tRAS)

The default setting for the Active to Precharge Delay is 7.

System Memory Frequency

This field sets the frequency of the DRAM memory installed. The default setting is *Auto*. The other settings are *DDR333*, *DDR400* and *DDR533*.

SLP_S4# Assertion Width

Pushing the power button for 1 to 2 seconds will power off the system. This will prevent the system from powering off in case you accidentally hit or pushed the power button.

System BIOS Cacheable

The setting of *Enabled* allows caching of the system BIOS ROM at F000h-FFFFh, resulting in better system performance. However, if any program writes to this memory area, a system error may result.

Video BIOS Cacheable

The Setting *Enabled* allows caching of the video BIOS ROM at C0000h-F7FFFh, resulting in better video performance. However, if any program writes to this memory area, a system error may result.

Memory Hole At 15-16M

In order to improve performance, certain space in memory can be reserved for ISA cards. This memory must be mapped into the memory space below 16 MB. The choices are *Enabled* and *Disabled*.

PCI Express Port 1/2/3/4

The default setting is *Auto*. The choices are *Enabled*, *Disabled* and *Auto*.

PCI-E Compliancy Mode

The default setting is *Auto*. Another mode is **v1.0**.

PEG/OnChip VGA Control

The default setting is *Auto*.

On-Chip Video Memory Size

Use this field to select On-Chip Frame Buffer Size, Fixed Memory Size and DVMT Memory Size. Total Graphics Memory can be set as 64MB, 128MB or 224MB.

On-Chip Frame Buffer Size

The On-Chip Frame Buffer Size can be set us 1MB, 8MB or 16MB. This memory is shared with the system memory.

FIXED Memory Size

Specify the size of system memory to allocate for video memory.

DVMT Memory Size

Specify the size of DVMT memory to allocate for video memory.

Integrated Peripherals

Phoenix - AwardBIOS CMOS Setup Utility
Integrated Peripherals

OnChip IDE Device	Press Enter	ITEM HELP
Onboard Device	Press Enter	Menu Level
SuperIO Device	Press Enter	
Onboard Lan Boot ROM	Disabled	

OnChip IDE Device

IDE HDD Block Mode	Enabled	ITEM HELP
IDE DMA transfer access	Enabled	Menu Level
On-Chip Primary PCI IDE	Enabled	
IDE Primary Master PIO	Auto	
IDE Primary Slave PIO	Auto	
IDE Primary Master UDMA	Auto	
IDE Primary Slave UDMA	Auto	
On-Chip Secondary PCI IDE	Enabled	
IDE Secondary Master PIO	Auto	
IDE Secondary Slave PIO	Auto	
IDE Secondary Master UDMA	Auto	
IDE Secondary Slave UDMA	Auto	
*** On-Chip Serial ATA Setting ***		
On-Chip Serial ATA	Auto	
PATA IDE Mode	Primary	
SATA Port	P1,P3 is Secondary	

Onboard Device

USB Controller	Enabled	ITEM HELP
USB 2.0 Controller	Enabled	Menu Level
USB Keyboard Support	Disabled	
USB Mouse Support	Disabled	
Azalia/AC97 Audio Select	Auto	
Onboard PCI-E Giga LAN1	Enabled	
Onboard PCI-E Giga LAN2	Enabled	

SuperIO Device

POWER ON Function	BUTTON ONLY	ITEM HELP
KB Power ON Password	Enter	Menu Level >
Hot Key Power ON	Ctrl-F1	
Onboard FDC Controller	Enabled	
Onboard Serial Port 1	3F8/IRQ4	
Onboard Serial Port 2	2F8/IRQ3	
UART Mode Select	Normal	
RxD, TxD Active	Hi, Lo	
IR Transmission Delay	Enabled	
UR2 Duplex Mode	Half	
Use IR Pins	IR-Rx2Tx2	
Onboard Parallel Port	378/IRQ7	
Parallel Port Mode	SPP	
EPP Mode Select	EPP1.7	
ECP Mode Use DMA	3	
PWRON After PWR-Fail	Off	

Onboard LAN Boot ROM

This field allows you to enable the on board LAN boot ROM. By default, this option is disabled.

IDE HDD Block Mode

This field allows your hard disk controller to use the fast block mode to transfer data to and from your hard disk drive.

IDE DMA Transfer Access

Use this field to enable or disable IDE DMA transfer access.

OnChip Primary/Secondary PCI IDE

The integrated peripheral controller contains an IDE interface with support for two IDE channels. Select *Enabled* to activate each channel.

IDE Primary/Secondary Master/Slave PIO

These fields allow your system hard disk controller to work faster. Rather than have the BIOS issue a series of commands that transfer to or from the disk drive, PIO (Programmed Input/Output) allows the BIOS to communicate with the controller and CPU directly.

The system supports five modes, numbered from 0 (default) to 4, which primarily differ in timing. When Auto is selected, the BIOS will select the best available mode.

IDE Primary/Secondary Master/Slave UDMA

These fields allow your system to improve disk I/O throughput to 33Mb/sec with the Ultra DMA/33 feature

On-Chip Serial ATA

The default setting of *Auto* allows the Serial ATA drive to be enabled, when the system detects one.

PATA IDE Mode

This item allows you to select the parallel ATA channel. Setting options are Primary and Secondary.

SATA Port

This feature allows users to view the SATA port as primary or secondary channel.

USB Controller

The options for this field are *Enabled* and *Disabled*. By default, this field is set to *Enabled*.

USB 2.0 Controller

The options for this field are *Enabled* and *Disabled*. By default, this field is set to *Enabled*. In order to use USB 2.0, necessary OS drivers must be installed first.

USB Keyboard Support

The options for this field are *Enabled* and *Disabled*. By default, this field is set to *Disabled*.

USB Mouse Support

The options for this field are *Enabled* and *Disabled*. By default, this field is set to *Disabled*.

Azalia/AC97 Audio Select

The default setting of the AC97 Audio is *Auto*.

Onboard PCI-E Giga LAN1/LAN2

The field enables or disables this Marvell Giga BaseT Ethernet controller.

Power ON Function

This field is related to how the system is powered on – such as with the use of conventional power button, keyboard or hot keys. The default is *BUTTON ONLY*.

KB Power ON Password

This field allows users to set the password when keyboard power on is the mode of the Power ON function.

Hot Key Power ON

This field sets certain keys, also known as hot keys, on the keyboard that can be used as a ‘switch’ to power on the system.

Onboard FDC Controller

Select *Enabled* if your system has a floppy disk controller (FDC) installed on the board and you wish to use it. If you install an add-in FDC or the system has no floppy drive, select *Disabled* in this field. This option allows you to select the onboard FDD port.

Onboard Serial/Parallel Port

These fields allow you to select the onboard serial and parallel ports and their addresses. The default values for these ports are:

Serial Port 1	3F8/IRQ4
Serial Port 2	2F8/IRQ3
Parallel Port	378H/IRQ7

UART Mode Select

This field determines the UART 2 mode in your computer. The default value is *Normal*. Other options include *IrDA* and *ASKIR*.

Parallel Port Mode

This field allows you to determine parallel port mode function.

SPP	Standard Printer Port
EPP	Enhanced Parallel Port
ECP	Extended Capabilities Port
ECP+EPP	Combination of ECP and EPP capabilities
Normal	Normal function

PWRON After PWR-Fail

This field sets the system power status whether *on* or *off* when power returns to the system from a power failure situation.

Power Management Setup

The Power Management Setup allows you to save energy of your system effectively.

Phoenix - AwardBIOS CMOS Setup Utility
Power Management Setup

		ITEM HELP
ACPI Function	Enabled	
Power Management	User Define	
Video Off Method	V/H SYNC+Blank	
Video Off In Suspend	Yes	
Suspend Type	Stop Grant	
Modem Use IRQ	3	
Suspend Mode	Disabled	
HDD Power Down	Disabled	
Soft-Off by PWR-BTTN	Instant-Off	
CPU THRM-Throttling	50%	
Wake-Up by PCI Card	Disabled	
Power On by Ring	Disabled	
Wake Up On LAN	Disabled	
Resume by Alarm	Disabled	
Date (of Month) Alarm	0	
Time (hh:mm:ss) Alarm	0 : 0 : 0	
** Reload Global Timer Events **		
Primary IDE 0	Disabled	
Primary IDE 1	Disabled	
Secondary IDE 0	Disabled	
Secondary IDE 1	Disabled	
FDD, COM, LPT Port	Disabled	
PCI PIRQ[A-D] #	Disabled	

ACPI Function

Enable this function to support ACPI (Advance Configuration and Power Interface).

Power Management

This field allows you to select the type of power saving management modes. There are four selections for Power Management.

Min. Power Saving	Minimum power management
Max. Power Saving	Maximum power management.
User Define	Each of the ranges is from 1 min. to 1hr. Except for HDD Power Down which ranges from 1 min. to 15 min.

Video Off Method

This field defines the Video Off features. There are three options.

V/H SYNC + Blank	Default setting, blank the screen and turn off vertical and horizontal scanning.
DPMS	Allows BIOS to control the video display.
Blank Screen	Writes blanks to the video buffer.

Video Off In Suspend

When enabled, the video is off in suspend mode.

Suspend Type

The default setting for the Suspend Type field is Stop Grant.

Modem Use IRQ

This field sets the IRQ used by the Modem. By default, the setting is 3.

Suspend Mode

When enabled, and after the set time of system inactivity, all devices except the CPU will be shut off.

HDD Power Down

When enabled, and after the set time of system inactivity, the hard disk drive will be powered down while all other devices remain active.

Soft-Off by PWRBTN

This field defines the power-off mode when using an ATX power supply. The Instant Off mode allows powering off immediately upon pressing the power button. In the Delay 4 Sec mode, the system powers off when the power button is pressed for more than four seconds or enters the suspend mode when pressed for less than 4 seconds.

Wake-Up by PCI Cards

Enable this field to allow wake up function through a PCI Ethernet card.

Power On by Ring

This field enables or disables the power on of the system through the modem connected to the serial port or LAN.

Wake Up On LAN

Enable this field to allow wake up function through the onboard LAN.

Resume by Alarm

This field enables or disables the resumption of the system operation. When enabled, the user is allowed to set the Date and Time.

Reload Global Timer Events

The HDD, FDD, COM, LPT Ports, and PCI PIRQ are I/O events which can prevent the system from entering a power saving mode or can awaken the system from such a mode. When an I/O device wants to gain the attention of the operating system, it signals this by causing an IRQ to occur. When the operating system is ready to respond to the request, it interrupts itself and performs the service.

PNP/PCI Configurations

This option configures the PCI bus system. All PCI bus systems on the system use INT#, thus all installed PCI cards must be set to this value.

Phoenix - AwardBIOS CMOS Setup Utility
PnP/PCI Configurations

		ITEM HELP
Init Display First	PCI Slot	Menu Level
Reset Configuration Data	Disabled	
Resources Controlled By	Auto (ESCD)	Default is Disabled.
IRQ Resources	Press Enter	Select Enabled to reset
DMA Resources	Press Enter	Extended System
		Configuration Data
		(ESCD) when you exit
		Setup if you have
		installed a new add-on
		and the system
		reconfiguration has
		caused such a serious
		conflict that the OS
		cannot boot
PCI/VGA Palette Snoop	Disabled	
INT Pin 1 Assignment	Auto	
INT Pin 2 Assignment	Auto	
INT Pin 3 Assignment	Auto	
INT Pin 4 Assignment	Auto	
INT Pin 5 Assignment	Auto	
INT Pin 6 Assignment	Auto	
INT Pin 7 Assignment	Auto	
INT Pin 8 Assignment	Auto	
** PCI Express relative items **		
Maximum Payload Size	4096	

Init Display First

By default, the system initializes the PCI Slot VGA when the system boots.

Reset Configuration Data

This field allows you to determine whether to reset the configuration data or not. The default value is *Disabled*.

Resources Controlled by

This PnP BIOS can configure all of the boot and compatible devices automatically with the use of a use a PnP OS such as Windows 95.

PCI/VGA Palette Snoop

Some non-standard VGA display cards may not show colors properly. This field allows you to set whether or not MPEG ISA/VESA VGA cards can work with PCI/VGA. When this field is enabled, a PCI/VGA can work with an MPEG ISA/VESA VGA card. When this field is disabled, a PCI/VGA cannot work with an MPEG ISA/VESA card.

Maximum Payload Size

PCI/VGA cannot work with an MPEG ISA/VESA card.

PC Health Status

This section shows the parameters in determining the PC Health Status. These parameters include temperatures, fan speeds and voltages.

Phoenix - AwardBIOS CMOS Setup Utility
PC Health Status

		ITEM HELP
CPU Warning Temperature	80°C/176°F	
System Temp	28°C/82°F	
CPU Temp	42°C/107°F	
CPU FAN Speed (CPU_FAN1/2)	5400 RPM	
System FAN Speed (FAN1)	5463 RPM	
System FAN Speed (FAN2)	5388 RPM	
Vcore(V)	1.02 V	
+3.3V	3.32 V	
+5 V	4.94 V	
+12 V	12.03 V	
-12 V	-12.44 V	
VBAT (V)	3.21V	
5VSB (V)	5.15V	
Shutdown Temperature	Disabled	
CPU Fan Failure Warning	Disabled	
Sys. Fan Failure Warning	Disabled	
Aux. Fan Failure Warning	Disabled	

CPU Warning Temperature

This field allows the user to set the temperature so that when the temperature is reached, the system sounds a warning. This function can help prevent damage to the system that is caused by overheating.

Shutdown Temperature

This field allows the user to set the temperature by which the system automatically shuts down once the threshold temperature is reached. This function can help prevent damage to the system that is caused by overheating.

Temperatures/Fan Speeds/Voltages

These fields are the parameters of the hardware monitoring function feature of the board. The values are read-only values as monitored by the system and show the PC health status.

CPU/Chassis Fan Failure Warning

When enabled, this field lets the system sounds a 'siren' audible warning to the user that the CPU fan or chassis fan has malfunctioned.

Frequency/Voltage Control

This section shows the user how to configure the processor frequency.

Phoenix - AwardBIOS CMOS Setup Utility
Frequency/Voltage Control

CPU Clock Ratio	14X	ITEM HELP
Auto Detect PCI Clk	Disabled	
Spread Spectrum	Disabled	Menu Level

CPU Clock Ratio

The CPU Ratio, also known as the CPU bus speed multiplier, can be configured through this field. This field will only appear if your CPU allows changes in the CPU clock ratio, such as in the case of engineering-sample CPUs.

Auto Detect PCI Clk

This field enables or disables the auto detection of the PCI clock.

Spread Spectrum

This field sets the value of the spread spectrum. The default setting is *Disabled*. This field is for CE testing use only.

Load Fail-Safe Defaults

This option allows you to load the troubleshooting default values permanently stored in the BIOS ROM. These default settings are non-optimal and disable all high-performance features.

Load Setup Defaults

This option allows you to load the default values to your system configuration. These default settings are optimal and enable all high performance features.

Set Supervisor/User Password

These two options set the system password. Supervisor Password sets a password that will be used to protect the system and Setup utility. User Password sets a password that will be used exclusively on the system. To specify a password, highlight the type you want and press <Enter>. The Enter Password: message prompts on the screen. Type the password, up to eight characters in length, and press <Enter>. The system confirms your password by asking you to type it again. After setting a password, the screen automatically returns to the main screen.

To disable a password, just press the <Enter> key when you are prompted to enter the password. A message will confirm the password to be disabled. Once the password is disabled, the system will boot and you can enter Setup freely.

Save & Exit Setup

This option allows you to determine whether or not to accept the modifications. If you type “Y”, you will quit the setup utility and save all changes into the CMOS memory. If you type “N”, you will return to Setup utility.

Exit Without Saving

Select this option to exit the Setup utility without saving the changes you have made in this session. Typing “Y” will quit the Setup utility without saving the modifications. Typing “N” will return you to Setup utility.

Drivers Installation

This section describes the installation procedures for software and drivers under the Windows 2000 and Windows XP. The software and drivers are included with the board. If you find the items missing, please contact the vendor where you made the purchase. The contents of this section include the following:

Intel 915G Chipset Software Intallation Utility	54
Intel 915G Chipset Graphics Driver.....	55
Realtek AC97 Codec Audio Driver Installation.....	56
Marvell 88E8053 LAN Drivers Installation.....	57

IMPORTANT NOTE:

After installing your Windows operating system (Windows 2000/XP), you must install first the Intel Chipset Software Installation Utility before proceeding with the drivers installation.

Intel 915G Chipset Software Intallation Utility

The Intel 915G Chipset Drivers should be installed first before the software drivers to enable Plug & Play INF support for Intel chipset components. Follow the instructions below to complete the installation under Windows 2000/XP. (Before installed Intel Chipset Software Intallation Utility,Please update your system to Windows 2000 SP4 or Windows XP SP1A)

1. Insert the CD that comes with the board and the screen below would appear. Click Intel Chipset Software Intallation Utility.



2. When the Welcome screen appears, click Next to continue.

3. Click Yes to accept the software license agreement and proceed with the installation process.

4. On Readme Information screen, click Next to continue the installation.

5. The Setup process is now complete. Click Finish to restart the computer and for changes to take effect. When the computer has restarted, the system will be able to find some devices. Restart your computer when prompted.

Intel 915G Chipset Graphics Driver

The Intel 915G Chipset Family Graphics Drivers come in the CD with the motherboard. Follow the instructions below to complete the installation under Windows 2000/XP.

1. Insert the CD that comes with the board and the screen below would appear. Click Intel 915G Chipset Family Graphics Driver.



2. When the Welcome screen appears, click Next to continue.

3. Click Yes to accept the software license agreement and proceed with the installation process.

4. The Setup process is now complete. Click Finish to restart the computer and for changes to take effect. When the computer has restarted, the system will be able to find some devices. Restart your computer when prompted.

Realtek AC97 Codec Audio Driver Installation

Follow the steps below to install the Realtek AC97 Codec Audio Drivers.

1. Insert the CD that comes with the board and the screen below would appear. Click Realtek AC97 Codec Audio Drivers to start the drivers installation.



2. Click Finish to restart the computer and for changes to take effect.

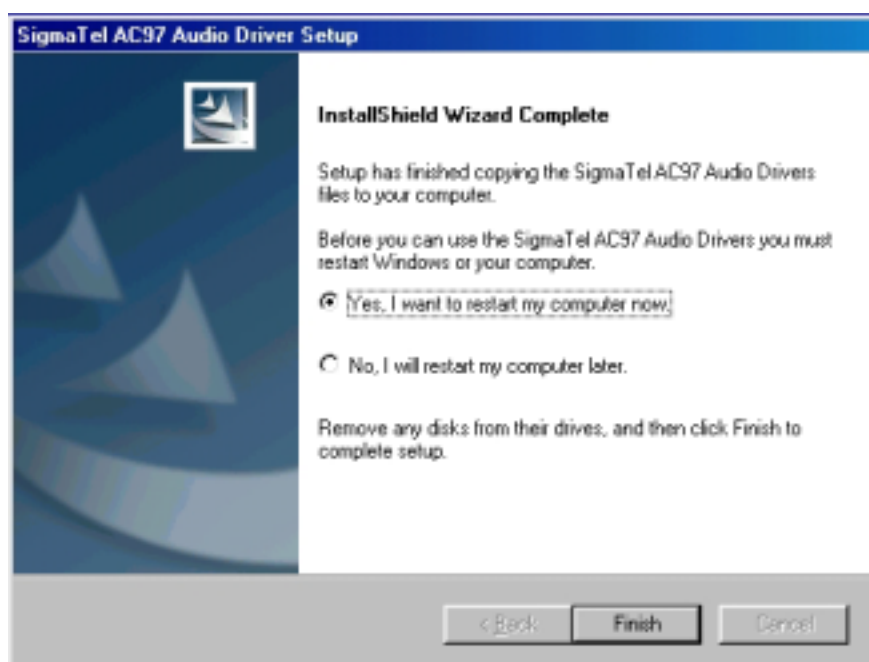

Marvell 88E8053 LAN Drivers Installation

Follow the steps below to start installing the Marvell 88E8053 PCI Express Gigabit LAN drivers.

1. Insert the CD that comes with the board. In the initial screen, click on LAN Card on the left side.



2. When the Welcome screen appears, click Next to start the drivers installation.

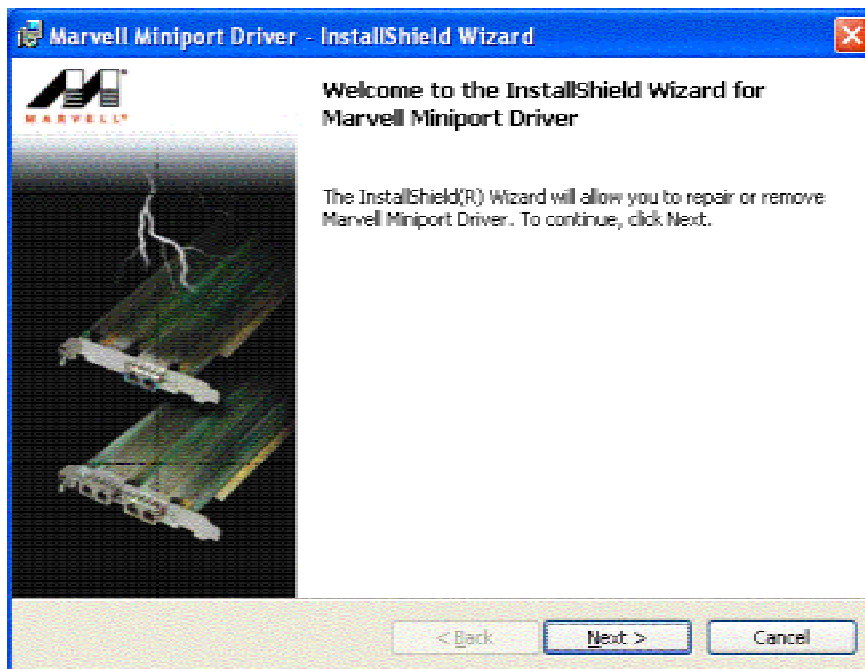

3. Click Finish to complete the setup and for changes to take effect.

This page is intentionally left blank.

Appendix

A. I/O Port Address Map

Each peripheral device in the system is assigned a set of I/O port addresses that also becomes the identity of the device. The following table lists the I/O port addresses used.

Address	Device Description
000h - 01Fh	DMA Controller #1
020h - 03Fh	Interrupt Controller #1
040h - 05Fh	Timer
060h - 06Fh	Keyboard Controller
070h - 07Fh	Real Time Clock, NMI
080h - 09Fh	DMA Page Register
0A0h - 0BFh	Interrupt Controller #2
0C0h - 0DFh	DMA Controller #2
0F0h	Clear Math Coprocessor Busy Signal
0F1h	Reset Math Coprocessor
1F0h - 1F7h	IDE Interface
278h - 27Fh	Parallel Port #2(LPT2)
2F8h - 2FFh	Serial Port #2(COM2)
2B0h - 2DFh	Graphics adapter Controller
378h - 3FFh	Parallel Port #1(LPT1)
360h - 36Fh	Network Ports
3B0h - 3BFh	Monochrome & Printer adapter
3C0h - 3CFh	EGA adapter
3D0h - 3DFh	CGA adapter
3F0h - 3F7h	Floppy Disk Controller
3F8h - 3FFh	Serial Port #1(COM1)

B. Interrupt Request Lines (IRQ)

Peripheral devices use interrupt request lines to notify CPU for the service required. The following table shows the IRQ used by the devices on board.

Level	Function
IRQ0	System Timer Output
IRQ1	Keyboard
IRQ2	Interrupt Cascade
IRQ3	Serial Port #2
IRQ4	Serial Port #1
IRQ5	Reserved
IRQ6	Floppy Disk Controller
IRQ7	Parallel Port #1
IRQ8	Real Time Clock
IRQ9	Reserved
IRQ10	Reserved
IRQ11	Reserved
IRQ12	PS/2 Mouse
IRQ13	80287
IRQ14	Primary IDE
IRQ15	Secondary IDE