

IB940

LGA775 Core™ 2 Duo
Intel® Q965 Chipset
Full Size CPU Card

USER'S MANUAL

Version 1.0A

Acknowledgments

Award is a registered trademark of Award Software International, Inc.

PS/2 is a trademark of International Business Machines Corporation.

Intel and Core 2 Duo are registered trademarks of Intel Corporation.

Microsoft Windows is a registered trademark of Microsoft Corporation.

Winbond is a registered trademark of Winbond Electronics Corporation.

All other product names or trademarks are properties of their respective owners.

Table of Contents

Introduction	1
Product Description.....	1
Checklist.....	2
Specifications	3
Board Dimensions	4
Installations	5
Installing the CPU	6
Installing the Memory	7
Setting the Jumpers	8
Connectors on IB940.....	12
BIOS Setup.....	25
Drivers Installation	45
Intel Q965 Chipset Software Installation Utility.....	46
Intel Q965 Chipset Graphics Driver.....	48
Realtek Codec Audio Driver Installation	50
Intel LAN Drivers Installation	51
Appendix	53
A. I/O Port Address Map.....	53
B. Interrupt Request Lines (IRQ).....	54
C. Watchdog Timer Configuration.....	55
D. Digital I/O Sample Code	59

ATTENTION:

It is strongly recommended that only heatsinks that have corresponding (metal) backplates be used on the CPU card. This is to avoid the CPU card being bent/distorted, causing the CPU card to become damaged. A reference picture of a backplate and heatsink that has backplate are shown below.

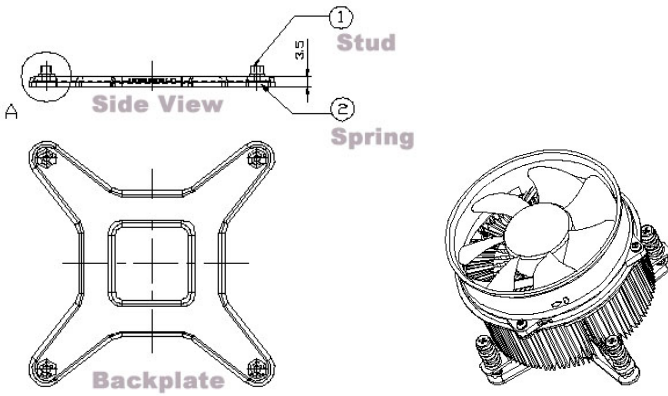

Introduction

Product Description

The IB940 CPU card is based on the Intel Q965 chipset and supports the Intel® Core™2 Duo processor with 1066/800/533 MHz System Bus. It supports the PCI Express x16 graphics interface for the latest high-performance graphics cards. The PCI Express x1 I/O ports offer up to 3.5X the bandwidth over traditional PCI architecture, delivering faster access to peripheral I/O devices.

The Intel GMA 3000 graphics on board supports Dual Independent Display and delivers richer visual color and picture clarity without the need for additional discrete graphics cards, and the integrated audio support enables premium digital sound and delivers advanced features such as multiple audio.

The CPU card also supports Dual-Channel DDR2 memory in four DIMM sockets and delivers up to 12.8 GB/s of bandwidth and 8 GB memory addressability for faster system responsiveness. Dimensions of the board are 338mm x 126mm.

The main features of the CPU card are:

- Intel® Q965 Express Chipset Based
- Support LGA775 Intel® Core™2 Duo Processors
- Support FSB 1066/800/533MHz
- Support up to 4GB DDRII 800/667/533 memory
- 1 x Mini PCI Express Slot
- Support one 10/100 or two Gigabit LAN on board
- 4 x SATA II, 1 x IDE, 1x Floppy, 6 x USB 2.0, 2 x COM, 1 x Parallel,
- 5.1Ch. Audio, 1 x TMDS
- Dual channel LVDS support 18/24 bit

Checklist

Your IB940 Core 2 Duo CPU Card package should include the items listed below:

- The IB940 Card
- This User's manual
- 1 x IDE cable
- 1 x Floppy cable
- 1 x SATA cable
- 1 x TMDS cable
- 2 Serial Port Ribbon Cable and 1 Parallel Port Attached to a Mounting Bracket
- 1 Y-Cable supporting a PS/2 Keyboard and a PS/2 Mouse
- Audio cable with bracket (Audio-18K)
- USB cable with bracket (USB2K-4)
- 1 CD containing the following:
 - Chipset Drivers
 - Flash Memory Utility
- Optional SATA Power Cord (PW34)

Specifications

Form Factor	Full Size CPU Card (PICMG1.0)
Processor	Support for Intel Core 2 Duo processor (Conroe core) in LGA775 socket
FSB	533/800/1066 MHz
Chipset	Intel Broadwater (Q965) Chipset consisting of: <ul style="list-style-type: none"> • Intel Q965 Graphics Memory Controller Hub (GMCH) • Intel ICH8/ICH8DO I/O Controller Hub
BIOS	<ul style="list-style-type: none"> • Award BIOS: footprint for both SPI & LPC I/F • Support for ACPI, SMBIOS
Memory	2x 240-pin DDRII 533/667/800 DIMM sockets, supports single channel, max. 4 GB
Video	Intel Q965 integrated graphics subsystem GMA3000
DVI	Chrontel CH7307C x1 for DVI
LVDS	Chrontel CH7308B x1 for 24-bit single/dual channel LVDS
LAN	LAN1: dual footprint support option: <ul style="list-style-type: none"> • Intel 82566DM Nineveh 10/100/1000 (IB940F) • Intel 82562V Ekron-N 10/100 (IB940) LAN2: Intel 82573L PCI-e gigabit LAN (IB940F)
Audio	Intel ICH8 built-in high definition audio w/ Realtek ALC888 Codec supports 5.1 CH audio (line-out, line-in & mic)
LPC I/O	Winbond W83627EHG: IrDA x1, Parallel x1, COM1 (RS232), COM2 (RS232/422/485), floppy, Hardware monitor (3 thermal inputs, 4 voltage monitor inputs & 2 fan headers)
USB	Intel ICH8 built-in two High Speed USB host controller, supports 6 USB 2.0 ports (support for USB port disable) w/ over-current protection
SATA II	Intel ICH8 built-in SATA II controller (3.0Gb/sec) w/ 4 ports
IDE	JMicron JM368 (PCI-e to PATA) x1 for 1 PATA channel
PCI-to-ISA bridge	ITE IT8888G x1 for high drive ISA bus
Expansion	Mini PCI-express socket x1 for Wireless LAN or other module
Edge Connector	<ul style="list-style-type: none"> • PS/2 connector x1 for PS/2 keyboard & Mouse, DB15 x1 for VGA, RJ45 x2 for LAN 1, 2
On Board Headers / Connectors	<ul style="list-style-type: none"> • Standard SATA (7-pin shrouded vertical) connector x4 • 40 pins, 0.1" pitch, standard box-header x1 for IDE • DF13-20 header x2 for LVDS • DF11-20 header x1 for DVI • 34 pins box-header x1 for floppy • 26 pins box-header x1 for printer • 5x2 pins box-header x2 for COM1-2 • 4 pins pin-header x1 for CPU fan • 3 pins pin-header x1 for system fan • 4x2 pins pin-header x3 for USB1-6
RTC	ICH8 built-in RTC with on-board lithium battery
Watchdog Timer	Yes (256 segments, 0, 1, 2...255 sec/min)
Digital IO	4 in and 4 out
System Voltage	+5V, +3.3V, +12V, -12V & 5VSB
Board Size	338 x 122mm

Board Dimensions

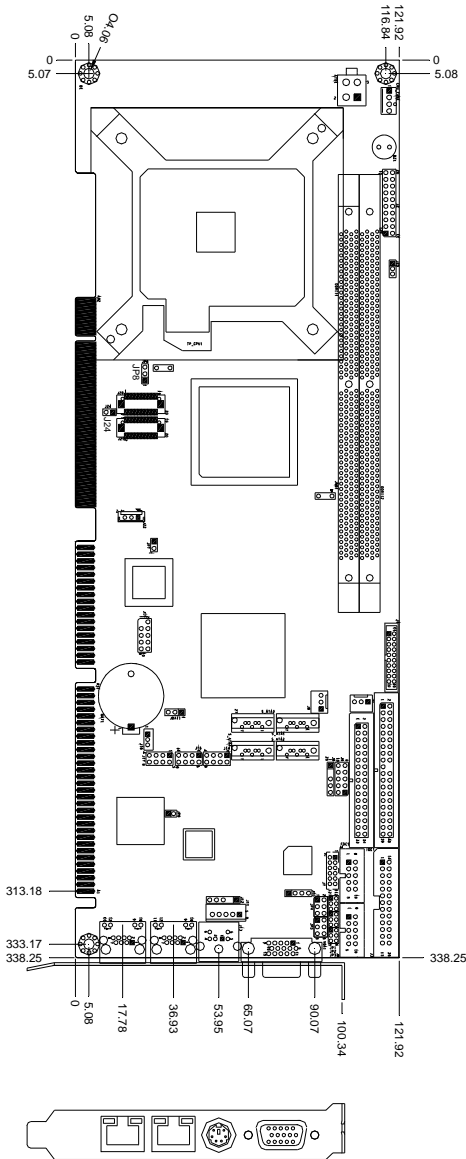

Installations

This section provides information on how to use the jumpers and connectors on the IB940 in order to set up a workable system. The topics covered are:

Installing the CPU	6
Installing the Memory	7
Setting the Jumpers	8
Connectors on IB940	12

Installing the CPU

The IB940 CPU Card supports an LGA 775 processor socket for Intel® Core 2 Duo processors.

The LGA 775 processor socket comes with a lever to secure the processor. Refer to the pictures below, from left to right, on how to place the processor into the CPU socket. ***Please note that the cover of the LGA775 socket must always be installed during transport to avoid damage to the socket.***

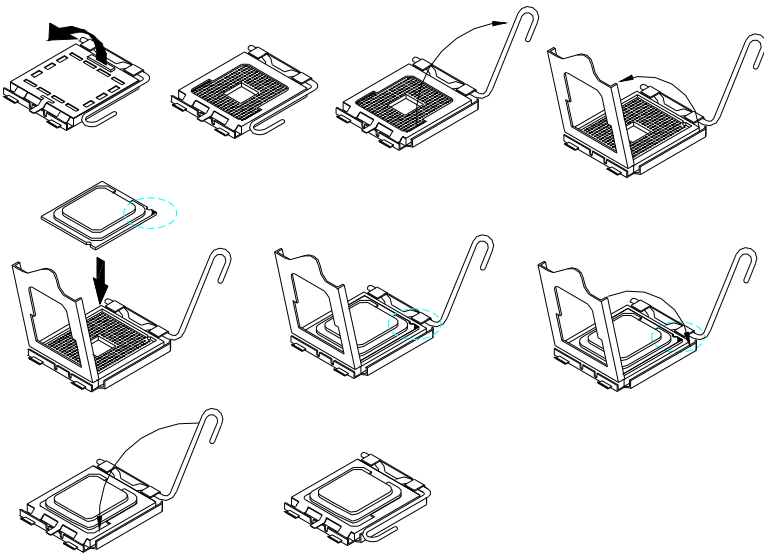

Installing the Memory

The IB940 CPU Card supports four DDR2 memory sockets for a maximum total memory of 4GB in DDR memory type. It supports DDR2 533/667/800.

Basically, the system memory interface has the following features:

- Supports two 64-bit wide DDR data channels
- Available bandwidth up to 6.4GB/s (DDR2 800) for single-channel mode.
- Supports 256Mb, 512Mb, 1Gb DDR2 technologies.
- Supports only x8, x16, DDR2 devices with four banks
- Supports only unbuffered DIMMs
- Supports opportunistic refresh
- Up to 32 simultaneously open pages (four per row, four rows maximum)

Installing and Removing Memory Modules

To install the DDR2 modules, locate the memory slot on the board and perform the following steps:

1. Hold the DDR2 module so that the key of the DDR2 module align with those on the memory slot.
2. Gently push the DDR2 module in an upright position until the clips of the slot close to hold the DDR2 module in place when the DDR module touches the bottom of the slot.
3. To remove the DDR2 module, press the clips with both hands.

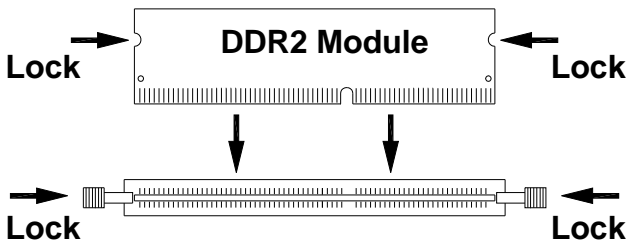

Setting the Jumpers

Jumpers are used on IB940 to select various settings and features according to your needs and applications. Contact your supplier if you have doubts about the best configuration for your needs. The following lists the connectors on IB940 and their respective functions.

Jumper Locations on IB940	9
JBAT1: Clear CMOS Contents.....	10
JP1, JP2, JP3: RS232/422/485 (COM2) Selection	10
JP4, JP5: COM1 / COM2 RS232 +5V/+12V Power Setting	10
JP7: Processor Setting.....	11
JP8: LVDS Panel Power Select	11
J25: Power Supply Type Select	11

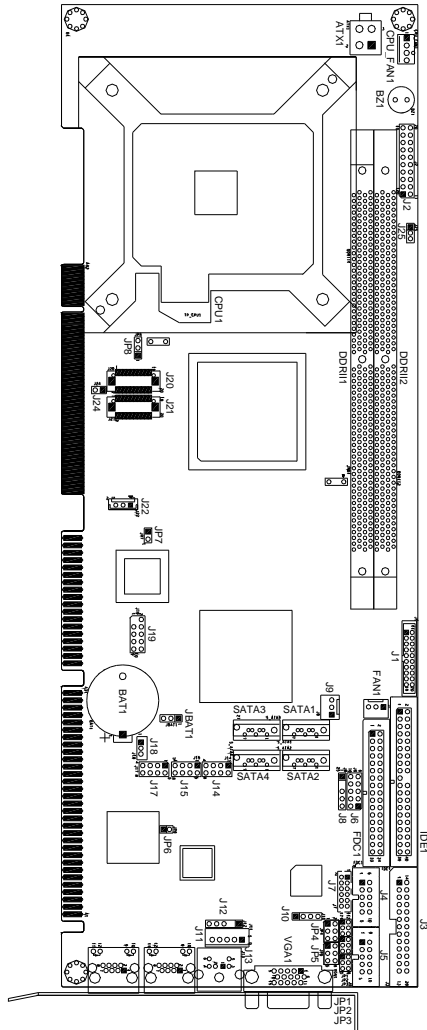

Jumper Locations on IB940



Jumpers on IB940.....	Page
JBAT1: Clear CMOS Contents.....	10
JP1, JP2, JP3: RS232/422/485 (COM2) Selection.....	10
JP4, JP5: COM1 / COM2 RS232 +5V/+12V Power Setting	10
JP7: Processor Setting.....	11
JP8: LVDS Panel Power Select	11
J25: Power Supply Type Select.....	11

JBAT1: Clear CMOS Contents

Use JBAT1, a 3-pin header, to clear the CMOS contents. *Note that the ATX-power connector should be disconnected from the CPU Card before clearing CMOS.*

JBAT1	Setting	Function
	Pin 1-2 Short/Closed	Normal
	Pin 2-3 Short/Closed	Clear CMOS

JP1, JP2, JP3: RS232/422/485 (COM2) Selection

COM1 is fixed for RS-232 use only.

COM2 is selectable for RS232, RS-422 and RS-485.

ID394: COM3 and COM4 are fixed for RS-232 use only. The following table describes the jumper settings for COM2 selection.





COM2 Function	RS-232	RS-422	RS-485
Jumper Setting (pin closed)	JP1: 1-2	JP1: 3-4	JP1: 5-6
	JP2: 3-5 & 4-6	JP2: 1-3 & 2-4	JP2: 1-3 & 2-4
	JP3: 3-5 & 4-6	JP3: 1-3 & 2-4	JP3: 1-3 & 2-4



JP4, JP5: COM1 / COM2 RS232 +5V/+12V Power Setting

JP4 / JP5	Setting	Function
	Pin 1-2 Short/Closed	+12V
	Pin 3-4 Short/Closed	Normal
	Pin 5-6 Short/Closed	+5V

JP7: Processor Setting



JP7	Setting	Processor Used
 Short	Pin 1-2 Short/Closed	Celeron D
 Open	Pin 1-2 Open	Core 2 Duo, Pentium D, Pentium 4 HT

JP8: LVDS Panel Power Select

JP8	Setting	Panel Voltage
 1 2 3	Pin 1-2 Short/Closed	3.3V (default)
 1 2 3	Pin 2-3 Short/Closed	5V

J25: Power Supply Type Select

Use J25, a 3-pin header, to select between AT and ATX power supply.

J25	Setting	Power Supply Type
 1 2 3	Pin 1-2 Short/Closed	ATX
 1 2 3	Pin 2-3 Short/Closed	AT

Connectors on IB940

The connectors on IB940 allows you to connect external devices such as keyboard, floppy disk drives, hard disk drives, printers, etc. The following table lists the connectors on IB940 and their respective functions.

Jumper Locations on IB940.....	13
CPU_FAN1: CPU Fan Power Connector.....	14
PWR_FAN1: SYSTEM Fan Power Connectors.....	14
VGA1: VGA CRT Connector.....	14
FDC1: Floppy Drive Connector	15
IDE1: Primary IDE Connectors	15
S_ATA1, S_ATA2, S_ATA3, S_ATA4: SATA HDD Connectors	16
ATX1: 12V/+12V Power Connector.....	16
J1: TMDS Panel Connector.....	16
J2: System Function Connector	17
J3: Parallel Port Connector	19
J4, J5: COM1 and COM2 Serial Ports Connector	19
J6: Digital I/O Connector (4 in, 4 out).....	20
J7: Audio Connector for 5.1 channel.....	20
J8: IrDA Connector.....	20
J9: External ATX Power Connector	20
J10: CD-In Audio Connector.....	21
J11, J12: External PS/2 Keyboard and Mouse Connector	21
J13: PS/2 Keyboard and Mouse Connector	21
J17, J15, J14: USB0/USB1 Connector	21
J16: Intel 82562V 10/100 or Intel 82566DC GbE RJ-45	22
<i>Note: 10/100 LAN for IB940; Gigabit LAN for IB940F</i>	22
J18: Wake On LAN Connector.....	22
J19: SPI Flash Connector (factory use only)	22
J20, J21: LVDS Connectors (1st channel, 2nd channel)	22
J22: Panel Inverter Power Connector	23
J23: Intel PCI Express GbE RJ45 Connector	23
U46: x1 Mini PCI Express Slot	23

The connectors on IB940 allows you to connect external devices such as keyboard, floppy disk drives, hard disk drives, printers, etc. The following table lists the connectors on IB940 and their respective functions.

CPU_FAN1: CPU Fan Power Connector

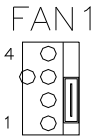

Pin #	Signal Name
4	Control
3	Sense
2	+12V
1	Ground

PWR_FAN1: SYSTEM Fan Power Connectors

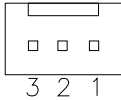

Pin #	Signal Name
1	Sense
2	+12V
3	Rotation detection

VGA1: VGA CRT Connector

VGA1 is a DB-15 VGA connector located beside the COM1 port. The following table shows the pin-out assignments of this connector.

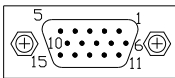

Signal Name	Pin #	Pin #	Signal Name
Red	1	2	Green
Blue	3	4	N.C.
GND	5	6	GND
GND	7	8	GND
VCC	9	10	GND
N.C.	11	12	DDCDATA
HSYNC	13	14	VSYNC
DDCCLK	15		

FDC1: Floppy Drive Connector

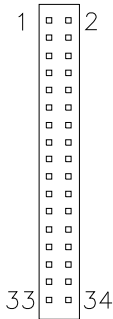

Signal Name	Pin #	Pin #	Signal Name
Ground	1	2	RM/LC
Ground	3	4	No connect
Ground	5	6	No connect
Ground	7	8	Index
Ground	9	10	Motor enable 0
Ground	11	12	Drive select 1
Ground	13	14	Drive select 0
Ground	15	16	Motor enable 1
Ground	17	18	Direction
Ground	19	20	Step
Ground	21	22	Write data
Ground	23	24	Write gate
Ground	25	26	Track 00
Ground	27	28	Write protect
Ground	29	30	Read data
Ground	31	32	Side 1 select
Ground	33	34	Diskette change

IDE1: Primary IDE Connectors

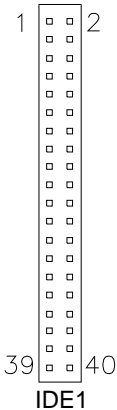

Signal Name	Pin #	Pin #	Signal Name
Reset IDE	1	2	Ground
Host data 7	3	4	Host data 8
Host data 6	5	6	Host data 9
Host data 5	7	8	Host data 10
Host data 4	9	10	Host data 11
Host data 3	11	12	Host data 12
Host data 2	13	14	Host data 13
Host data 1	15	16	Host data 14
Host data 0	17	18	Host data 15
Ground	19	20	Protect pin
DRQ0	21	22	Ground
Host IOW	23	24	Ground
Host IOR	25	26	Ground
IOCHRDY	27	28	Host ALE
DACK0	29	30	Ground
IRQ14	31	32	No connect
Address 1	33	34	No connect
Address 0	35	36	Address 2
Chip select 0	37	38	Chip select 1
Activity	39	40	Ground

S_ATA1, S_ATA2, S_ATA3, S_ATA4: SATA HDD Connectors

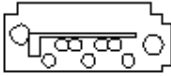

Pin #	Signal Name
1	Ground
2	TX+
3	TX-
4	Ground
5	RX-
6	RX+
7	Ground

ATX1: 12V/+12V Power Connector

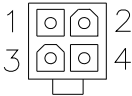

Pin #	Signal Name
1	Ground
2	Ground
3	+12V
4	+12V

J1: TMDS Panel Connector

TMDS stands Transition Minimized Differential Signaling.

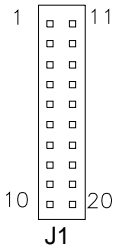

Signal Name	Pin #	Pin #	Signal Name
TX1P	1	11	TX2P
TXIN	2	12	TX2N
GND	3	13	GND
GND	4	14	GND
TXCP	5	15	TX0P
TXCN	6	16	TX0N
GND	7	17	NC
+5v	8	18	NC
HTPG	9	19	DDCDATA
NC	10	20	DDCCLK

J2: System Function Connector

J2 provides connectors for system indicators that provide light indication of the computer activities and switches to change the computer status. J1 is a 20-pin header that provides interfaces for the following functions.

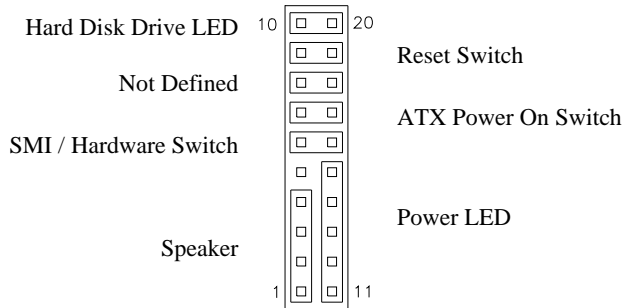

Speaker: Pins 1 - 4

This connector provides an interface to a speaker for audio tone generation. An 8-ohm speaker is recommended.

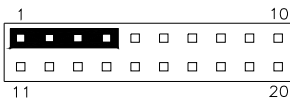

Pin #	Signal Name
1	Speaker out
2	No connect
3	Ground
4	+5V

Power LED: Pins 11 - 15

The power LED indicates the status of the main power switch.

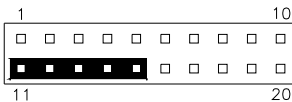

Pin #	Signal Name
11	Power LED
12	No connect
13	Ground
14	No connect
15	Ground

SMI/Hardware Switch: Pins 6 and 16

This connector supports the "Green Switch" on the control panel, which, when pressed, will force the system into the power-saving mode immediately.

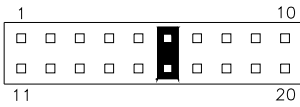

Pin #	Signal Name
6	SMI
16	Ground

ATX Power ON Switch: Pins 7 and 17

This 2-pin connector is an "ATX Power Supply On/Off Switch" on the system that connects to the power switch on the case. When pressed, the power switch will force the system to power on. When pressed again, it will force the system to power off.

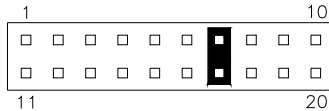

Reset Switch: Pins 9 and 19

The reset switch allows the user to reset the system without turning the main power switch off and then on again. Orientation is not required when making a connection to this header.

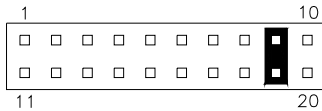

Hard Disk Drive LED Connector: Pins 10 and 20

This connector connects to the hard drive activity LED on control panel. This LED will flash when the HDD is being accessed.

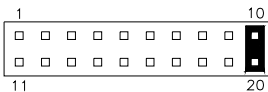

Pin #	Signal Name
10	HDD Active
20	5V

J3: Parallel Port Connector

The following table describes the pin out assignments of this connector.

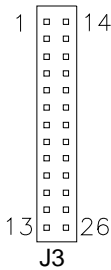

Signal Name	Pin #	Pin #	Signal Name
Line printer strobe	1	14	AutoFeed
PD0, parallel data 0	2	15	Error
PD1, parallel data 1	3	16	Initialize
PD2, parallel data 2	4	17	Select
PD3, parallel data 3	5	18	Ground
PD4, parallel data 4	6	19	Ground
PD5, parallel data 5	7	20	Ground
PD6, parallel data 6	8	21	Ground
PD7, parallel data 7	9	22	Ground
ACK, acknowledge	10	23	Ground
Busy	11	24	Ground
Paper empty	12	25	Ground
Select	13	N/A	N/A

J4, J5: COM1 and COM2 Serial Ports Connector

J4 and J5 both 10-pin headers, are the onboard serial port connectors.

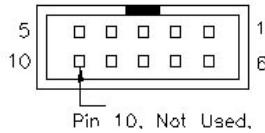

J4
Fixed as
RS-232

J5
Configurable
as RS-232/
RS-422/485
with jumpers
JP1/JP2/JP3

Pin #	Signal Name		
	RS-232	RS-422	RS-485
1	DCD	TX-	DATA-
2	RX	TX+	DATA+
3	TX	RX+	NC
4	DTR	RX-	NC
5	GND	GND	GND
6	DSR	NC	NC
7	RTS	NC	NC
8	CTS	NC	NC
9	RI	NC	NC
10	NC	NC	NC

J6: Digital I/O Connector (4 in, 4 out)

This 10-pin digital I/O connector supports TTL levels and is used to control external devices requiring ON/OFF circuitry.

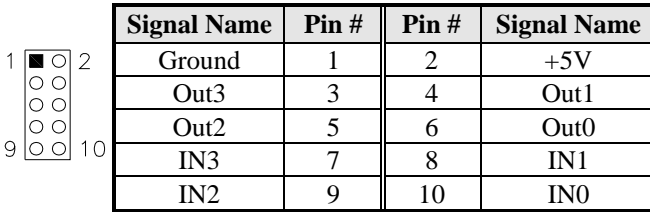

J7: Audio Connector for 5.1 channel

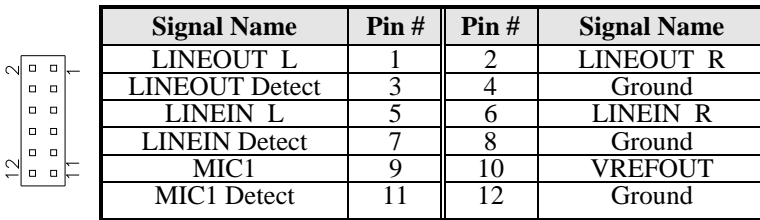

J8: IrDA Connector

J8 is used for an optional IrDA connector for wireless communication.

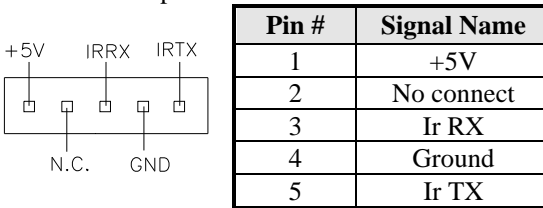

J9: External ATX Power Connector

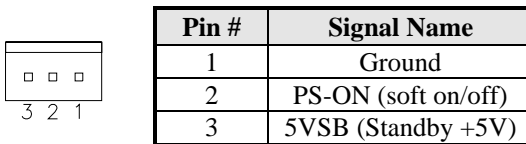

J10: CD-In Audio Connector

Pin #	Signal Name
1	CD Audio R
2	Ground
3	Ground
4	CD Audio L



J11, J12: External PS/2 Keyboard and Mouse Connector

Pin #	J11	J12
1	KB clock	Mouse data
2	KB data	N.C.
3	N.C.	Ground
4	Ground	Vcc
5	Vcc	Mouse clock

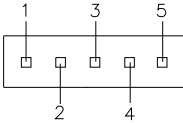

J13: PS/2 Keyboard and Mouse Connector

J13 uses a Y-cable with dual D-connectors for a PS/2 keyboard and a PS/2 mouse.

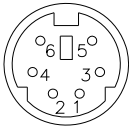

Pin #	Signal Name
1	Keyboard data
2	Mouse data
3	Ground
4	Vcc
5	Keyboard Clock
6	Mouse Clock

J17, J15, J14: USB0/USB1 Connector

Signal Name	Pin	Pin	Signal Name
Vcc	1	2	Ground
USB0-	3	4	USB1+
USB0+	5	6	USB1-
Ground	7	8	Vcc



J16: Intel 82562V 10/100 or Intel 82566DC GbE RJ-45

J16 is the 10/100 or Gigabit LAN RJ45 connector based on the Intel PCI Express 10/100 or GbE controller.

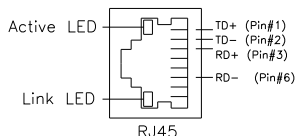

Note: 10/100 LAN for IB940; Gigabit LAN for IB940F

J18: Wake On LAN Connector

J18 is a 3-pin header for the Wake On LAN function on the CPU Card. The following table shows the pin out assignments of this connector. Wake On LAN will function properly only with an ATX power supply with 5VSB that has 1A.

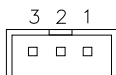

Pin #	Signal Name
1	+5VSB
2	Ground
3	LAN Wakeup

J19: SPI Flash Connector (factory use only)

J20, J21: LVDS Connectors (1st channel, 2nd channel)

The LVDS connectors, DF13 20-pin mating connectors, are composed of the first channel (J5) and second channel (J10) to support 24-bit or 48-bit.

Diagram of a 20-pin connector with pins labeled 1 through 20.

Signal Name	Pin #	Pin #	Signal Name
TX0-	2	1	TX0+
Ground	4	3	Ground
TX1-	6	5	TX1+
5V/3.3V	8	7	Ground
TX3-	10	9	TX3+
TX2-	12	11	TX2+
Ground	14	13	Ground
TXC-	16	15	TXC+
5V/3.3V	18	17	ENABKL
+12V	20	19	+12V

Remarks: Maximum current for +12V is 1A.

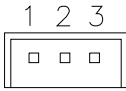
J22: Panel Inverter Power Connector

Pin #	Signal Name
1	+12V
2	ENABKL
3	Ground

Remarks: Maximum current is 1A.

J23: Intel PCI Express GbE RJ45 Connector

J23 is the Gigabit LAN RJ45 connector based on the Intel PCI Express GbE controller.

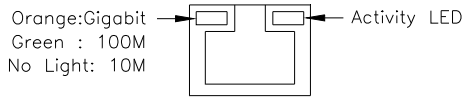
**U46: x1 Mini PCI Express Slot**

This page is intentionally left blank.

BIOS Setup

This chapter describes the different settings available in the Award BIOS that comes with the board. The topics covered in this chapter are as follows:

BIOS Introduction	26
BIOS Setup	26
Standard CMOS Setup	28
Advanced BIOS Features	31
Advanced Chipset Features	34
Integrated Peripherals	35
Power Management Setup	38
PNP/PCI Configurations	41
PC Health Status	42
Frequency/Voltage Control	43
Load Fail-Safe Defaults	44
Load Optimized Defaults	44
Set Supervisor/User Password	44
Save & Exit Setup	44
Exit Without Saving	44

BIOS Introduction

The Award BIOS (Basic Input/Output System) installed in your computer system's ROM supports Intel processors. The BIOS provides critical low-level support for a standard device such as disk drives, serial ports and parallel ports. It also adds virus and password protection as well as special support for detailed fine-tuning of the chipset controlling the entire system.

BIOS Setup

The Award BIOS provides a Setup utility program for specifying the system configurations and settings. The BIOS ROM of the system stores the Setup utility. When you turn on the computer, the Award BIOS is immediately activated. Pressing the key immediately allows you to enter the Setup utility. If you are a little bit late pressing the key, POST (Power On Self Test) will continue with its test routines, thus preventing you from invoking the Setup. If you still wish to enter Setup, restart the system by pressing the "Reset" button or simultaneously pressing the <Ctrl>, <Alt> and <Delete> keys. You can also restart by turning the system Off and back On again. The following message will appear on the screen:

```
Press <DEL> to Enter Setup
```

In general, you press the arrow keys to highlight items, <Enter> to select, the <PgUp> and <PgDn> keys to change entries, <F1> for help and <Esc> to quit.

When you enter the Setup utility, the Main Menu screen will appear on the screen. The Main Menu allows you to select from various setup functions and exit choices.

Phoenix - AwardBIOS CMOS Setup Utility

Standard CMOS Features	Frequency/Voltage Control
Advanced BIOS Features	Load Fail-Safe Defaults
Advanced Chipset Features	Load Optimized Defaults
Integrated Peripherals	Set Supervisor Password
Power Management Setup	Set User Password
PnP/PCI Configurations	Save & Exit Setup
PC Health Status	Exit Without Saving
ESC : Quit	↑ ↓ → ← : Select Item
F10 : Save & Exit Setup	
Time, Date, Hard Disk Type...	

The section below the setup items of the Main Menu displays the control keys for this menu. At the bottom of the Main Menu just below the control keys section, there is another section, which displays information on the currently highlighted item in the list.

Note: *If the system cannot boot after making and saving system changes with Setup, the Award BIOS supports an override to the CMOS settings that resets your system to its default.*

Warning: *It is strongly recommended that you avoid making any changes to the chipset defaults. These defaults have been carefully chosen by both Award and your system manufacturer to provide the absolute maximum performance and reliability. Changing the defaults could cause the system to become unstable and crash in some cases.*

Standard CMOS Setup

“Standard CMOS Setup” choice allows you to record some basic hardware configurations in your computer system and set the system clock and error handling. If the motherboard is already installed in a working system, you will not need to select this option. You will need to run the Standard CMOS option, however, if you change your system hardware configurations, the onboard battery fails, or the configuration stored in the CMOS memory was lost or damaged.

Phoenix - AwardBIOS CMOS Setup Utility
Standard CMOS Features

Date (mm:dd:yy)	Fri, Oct 20, 2006	Item Help
Time (hh:mm:ss)	16 : 11 : 00	Menu Level >
IDE Channel 0 Master	None	Change the day, month, Year and century
IDE Channel 0 Slave	None	
IDE Channel 1 Master	None	
IDE Channel 1 Slave	None	
IDE Channel 2 Master	None	
IDE Channel 3 Master	None	
IDE Channel 4 Master	None	
IDE Channel 4 Slave	None	
Drive A	1.44M, 3.5 in	
Drive B	None	
Video	EGA/VGA	
Halt On	All , But Keyboard	
Base Memory	640K	
Extended Memory	2086912K	
Total Memory	2087936K	

At the bottom of the menu are the control keys for use on this menu. If you need any help in each item field, you can press the <F1> key. It will display the relevant information to help you. The memory display at the lower right-hand side of the menu is read-only. It will adjust automatically according to the memory changed. The following describes each item of this menu.

Date

The date format is:

Day : Sun to Sat
Month : 1 to 12
Date : 1 to 31
Year : 1999 to 2099

To set the date, highlight the “Date” field and use the PageUp/PageDown or +/- keys to set the current time.

Time

The time format is: **Hour : 00 to 23**
Minute : 00 to 59
Second : 00 to 59

To set the time, highlight the “Time” field and use the <PgUp>/<PgDn> or +/- keys to set the current time.

IDE Channel Master/Slave

The onboard Serial ATA connectors provide Primary and Secondary channels for connecting up to four Serial ATA hard disks . Each channel can support up to two hard disks; the first is the “Master” and the second is the “Slave”.

Press <Enter> to configure the hard disk. The selections include Auto, Manual, and None. Select ‘Manual’ to define the drive information manually. You will be asked to enter the following items.

Capacity : Capacity/size of the hard disk drive
Cylinder : Number of cylinders
Head : Number of read/write heads
Precomp : Write precompensation
Landing Zone : Landing zone
Sector : Number of sectors

The Access Mode selections are as follows:

CHS (HD < 528MB)
 LBA (HD > 528MB and supports Logical Block Addressing)
 Large (for MS-DOS only)
 Auto

Drive A / Drive B

These fields identify the types of floppy disk drive A or drive B that has been installed in the computer. The available specifications are:

360KB	1.2MB	720KB	1.44MB	2.88MB
5.25 in.	5.25 in.	3.5 in.	3.5 in.	3.5 in.

Video

This field selects the type of video display card installed in your system.

You can choose the following video display cards:

EGA/VGA	For EGA, VGA, SEGA, SVGA or PGA monitor adapters. (default)
CGA 40	Power up in 40 column mode.
CGA 80	Power up in 80 column mode.
MONO	For Hercules or MDA adapters.

Halt On

This field determines whether or not the system will halt if an error is detected during power up.

No errors	The system boot will not be halted for any error that may be detected.
All errors	Whenever the BIOS detects a non-fatal error, the system will stop and you will be prompted.
All, But Keyboard	The system boot will not be halted for a keyboard error; it will stop for all other errors
All, But Diskette	The system boot will not be halted for a disk error; it will stop for all other errors.
All, But Disk/Key	The system boot will not be halted for a keyboard or disk error; it will stop for all others.

Advanced BIOS Features

This section allows you to configure and improve your system and allows you to set up some system features according to your preference.

Phoenix - AwardBIOS CMOS Setup Utility
Advanced BIOS Features

		ITEM HELP
CPU Feature	Press Enter	
Hard Disk Boot Priority	Press Enter	
Virus Warning	Disabled	Menu Level >
CPU L1 and L2 Cache	Enabled	
CPU L3 Cache	Enabled	
Quick Power On Self Test	Enabled	
First Boot Device	Floppy	
Second Boot Device	Hard Disk	
Third Boot Device	CDROM	
Boot Other Device	Enabled	
Swap Floppy Drive	Disabled	
Boot up Floppy Seek	Disabled	
Boot Up NumLock Status	On	
Gate A20 Option	Fast	
Typematic Rate Setting	Disabled	
Typematic Rate (Chars/Sec)	6	
Typematic Delay (Msec)	250	
Security Option	Setup	
APIC Mode	Enabled	
MPS Version Control for OS	1.4	
OS Select For DRAM>64MB	Non-OS2	
Report No FDD for Win95	Yes	
Small Logo (EPA) Show	Disabled	

CPU Feature

Press Enter to configure the settings relevant to CPU Feature.

Hard Disk Boot Priority

With the field, there is the option to choose, aside from the hard disks connected, "Bootable add-in Cards" which refers to other external devices.

Virus Warning

If this option is enabled, an alarm message will be displayed when trying to write on the boot sector or on the partition table on the disk, which is typical of the virus.

CPU L1 / L2 / L3 Cache

Cache memory is additional memory that is much faster than conventional DRAM (system memory). CPUs from 486-type on up contain internal cache memory, and most, but not all, modern PCs have additional (external) cache memory. When the CPU requests data, the system transfers the requested data from the main DRAM into cache memory, for even faster access by the CPU. These items allow you to enable (speed up memory access) or disable the cache function. By default, these items are Enabled.

Hyper-Threading Technology

Hyper-Threading Technology enables two logical processors on a single physical processor by replicating, partitioning, and sharing the resources within the Intel NetBurst microarchitecture pipeline.

Quick Power On Self Test

When enabled, this field speeds up the Power On Self Test (POST) after the system is turned on. If it is set to *Enabled*, BIOS will skip some items.

First/Second/Third Boot Device

These fields determine the drive that the system searches first for an operating system. The options available include *LS120*, *Hard Disk*, *CDROM*, *ZIP100*, *USB-FDD*, *USB-ZIP*, *USB-CDROM* and *Disabled*.

Boot Other Device

These fields allow the system to search for an OS from other devices other than the ones selected in the First/Second/Third Boot Device.

Swap Floppy Drive

The default setting is *Disabled*.

Boot up Floppy Seek

The default setting is *Disabled*.

Boot Up NumLock Status

This allows you to activate the NumLock function after you power up the system.

Gate A20 Option

This field allows you to select how Gate A20 is worked. Gate A20 is a device used to address memory above 1 MB.

Typematic Rate Setting

When disabled, continually holding down a key on your keyboard will generate only one instance. When enabled, you can set the two typematic controls listed next. By default, this field is set to *Disabled*.

Typematic Rate (Chars/Sec)

When the typematic rate is enabled, the system registers repeated keystrokes speeds. Settings are from 6 to 30 characters per second.

Typematic Delay (Msec)

When the typematic rate is enabled, this item allows you to set the time interval for displaying the first and second characters. By default, this item is set to *250msec*.

Security Option

This field allows you to limit access to the System and Setup. The default value is *Setup*. When you select *System*, the system prompts for the User Password every time you boot up. When you select *Setup*, the system always boots up and prompts for the Supervisor Password only when the Setup utility is called up.

APIC Mode

APIC stands for Advanced Programmable Interrupt Controller. The default setting is *Enabled*.

MPS Version Control for OS

This option specifies the MPS (Multiprocessor Specification) version for the OS. MPS version 1.4 added extended configuration tables to improve support for multiple PCI bus configurations and improve future expandability. The default setting is *1.4*.

OS Select for DRAM > 64MB

This option allows the system to access greater than 64MB of DRAM memory when used with OS/2 that depends on certain BIOS calls to access memory. The default setting is *Non-OS/2*.

Report No FDD for Win95

The default setting is *Yes*.

Small Logo (EPA) Show

The EPA logo appears at the right side of the monitor screen when the system is boot up. The default setting is *Disabled*.

Advanced Chipset Features

This Setup menu controls the configuration of the chipset.

Phoenix - AwardBIOS CMOS Setup Utility
Advanced Chipset Features

System BIOS Cacheable	Enabled	ITEM HELP
Memory Hole at 15M-16M	Disabled	
PCI Express Root Port Func	Press Enter	Menu Level >
** VGA Setting **		
PEG/On Chip VGA Control	Auto	
On-Chip Frame Buffer Size	8MB	
DVMT Mode	DVMT	
DVMT/FIXED memory Size	128MB	
SDVO Device Setting	None	
SDVO LVDS Protocol	1 Ch SPWVG 18bit	
SDVO Panel Number	1024 x 768	
Boot Display	Auto	

System BIOS Cacheable

The setting of *Enabled* allows caching of the system BIOS ROM at F000h-FFFFh, resulting in better system performance. However, if any program writes to this memory area, a system error may result.

Memory Hole At 15M-16M

In order to improve performance, certain space in memory can be reserved for ISA cards. This memory must be mapped into the memory space below 16 MB. The choices are *Enabled* and *Disabled*.

On-Chip VGA Setting

The fields under the On-Chip VGA Setting and their default settings are:

- PEG/On Chip VGA Control: Auto
- On-Chip Frame Buffer Size: 8MB
- DVMT Mode: DVMT
- DVMT/Fixed Memory Size: 128MB

SDVO Device Setting

The default setting is *None*, and other options are *LVDS*, *LVDS+DVI*, and *DVI*.

Boot Display

The default setting is *Auto* and other options are *CRT*, *LVDS*, *CRT+LVDS*, *DVI*, and *CRT+DVI*.

Integrated Peripherals

This section sets configurations for your hard disk and other integrated peripherals. The first screen shows three main items for user to select. Once an item selected, a submenu appears. Details follow.

Phoenix - AwardBIOS CMOS Setup Utility
Integrated Peripherals

OnChip IDE Device	Press Enter	ITEM HELP
SuperIO Device	Press Enter	Menu Level >
USB Device Setting	Press Enter	

Phoenix - AwardBIOS CMOS Setup Utility
OnChip IDE Device

IDE HDD Block Mode	Enabled	ITEM HELP
IDE DMA transfer access	Enabled	Menu Level >
IDE Primary Master PIO	Auto	
IDE Primary Slave PIO	Auto	
IDE Primary Master UDMA	Auto	
IDE Primary Slave UDMA	Auto	
On-Chip Secondary PCI IDE	Enabled	
IDE Secondary Master PIO	Auto	
IDE Secondary Slave PIO	Auto	
IDE Secondary Master UDMA	Auto	
IDE Secondary Slave UDMA	Auto	
LEGACY Mode Support	Enabled	

Phoenix - AwardBIOS CMOS Setup Utility
SuperIO Device

POWER ON Function	BUTTON ONLY	ITEM HELP
KB Power ON Password	Enter	Menu Level >
Hot Key power ON	Ctrl-F1	
Onboard Serial Port 1	3F8/IRQ4	
Onboard Serial Port 2	2F8/IRQ3	
UART Mode Select	Normal	
Onboard Parallel Port	378/IRQ7	
Parallel Port Mode	SPP	
PWRON After PWR-Fail	Off	

Phoenix - AwardBIOS CMOS Setup Utility
USB Device Setting

USB 1.0 Controller	Enabled	ITEM HELP
USB 2.0 Controller	Enabled	Menu Level >
USB Keyboard Function	Disabled	
USB Mouse Function	Disabled	
USB Storage Function	Enabled	
*** USB Mass Storage Device Boot Setting ***		

IDE HDD Block Mode

This field allows your hard disk controller to use the fast block mode to transfer data to and from your hard disk drive.

IDE DMA Transfer Access

This field, by default, is enabled

OnChip Secondary PCI IDE

This field, by default, is enabled

IDE Primary/Secondary Master/Slave PIO

These fields allow your system hard disk controller to work faster. Rather than have the BIOS issue a series of commands that transfer to or from the disk drive, PIO (Programmed Input/Output) allows the BIOS to communicate with the controller and CPU directly.

The system supports five modes, numbered from 0 (default) to 4, which primarily differ in timing. When Auto is selected, the BIOS will select the best available mode.

IDE Primary/Secondary Master/Slave UDMA

These fields allow your system to improve disk I/O throughput to 33Mb/sec with the Ultra DMA/33 feature. The options are *Auto* and *Disabled*.

LEGACY Mode Support

When the Serial ATA (SATA) is set with the legacy mode enabled, then the SATA is set to the conventional IDE mode. Legacy mode is otherwise known as compatible mode.

Power ON Function

This field is related to how the system is powered on – such as with the use of conventional power button, keyboard or hot keys. The default is **BUTTON ONLY**.

KB Power ON Password

This field allows users to set the password when keyboard power on is the mode of the Power ON function.

Hot Key Power ON

This field sets certain keys, also known as hot keys, on the keyboard that can be used as a ‘switch’ to power on the system.

Onboard Serial/Parallel Port

These fields allow you to select the onboard serial and parallel ports and their addresses. The default values for these ports are:

Serial Port 1	3F8/IRQ4
Serial Port 2	2F8/IRQ3
Parallel Port	378H/IRQ7

UART Mode Select

This field determines the UART 2 mode in your computer. The default value is *Normal*. Other options include *IrDA* and *ASKIR*.

Parallel Port Mode

This field allows you to determine parallel port mode function.

SPP	Standard Printer Port
EPP	Enhanced Parallel Port
ECP	Extended Capabilities Port

PWRON After PWR-Fail

This field sets the system power status whether *on* or *off* when power returns to the system from a power failure situation.

USB 1.0 Controller

The options for this field are *Enabled* and *Disabled*. By default, this field is set to *Enabled*.

USB 2.0 Controller

The options for this field are *Enabled* and *Disabled*. By default, this field is set to *Enabled*. In order to use USB 2.0, necessary OS drivers must be installed first. *Please update your system to Windows 2000 SP4 or Windows XP SP2.*

USB Keyboard/Mouse/Storage Function

The options for this field are *Enabled* and *Disabled*. By default, this field is set to *Disabled*.

Power Management Setup

Phoenix - AwardBIOS CMOS Setup Utility
Power Management Setup

ACPI Function	Enabled	ITEM HELP
ACPI Suspend	S3(STR)	
Power Management	User Define	Menu Level >
Video Off Method	V/H SYNC+Blank	
Video Off In Suspend	Yes	
Suspend Type	Stop Grant	
Modem Use IRQ	3	
Suspend Mode	Disabled	
HDD Power Down	Disabled	
Soft-Off by PWR-BTTN	Instant-Off	
CPU THRM-Throttling	75.0%	
Wake Up by PCI card	Disabled	
Power On by Ring	Disabled	
Resume by Alarm	Disabled	
Date (of Month) Alarm	0	
Time (hh:mm:ss) Alarm	0 : 0 : 0	
** Reload Global Timer Events **		
Primary IDE 0	Disabled	
Primary IDE 1	Disabled	
Secondary IDE 0	Disabled	
Secondary IDE 1	Disabled	
FDD, COM, LPT Port	Disabled	
PCI PIRQ[A-D] #	Disabled	

ACPI Function

Enable this function to support ACPI (Advance Configuration and Power Interface).

ACPI Suspend

The default setting of the ACPI Suspend mode is **S3(STR)**.

Power Management

This field allows you to select the type of power saving management modes. There are four selections for Power Management.

Min. Power Saving	Minimum power management
Max. Power Saving	Maximum power management.
User Define	Each of the ranges is from 1 min. to 1hr. Except for HDD Power Down which ranges from 1 min. to 15 min.

Video Off Method

This field defines the Video Off features. There are three options.

V/H SYNC + Blank	Default setting, blank the screen and turn off vertical and horizontal scanning.
DPMS	Allows BIOS to control the video display.
Blank Screen	Writes blanks to the video buffer.

Video Off In Suspend

When enabled, the video is off in suspend mode.

Suspend Type

The default setting for the Suspend Type field is *Stop Grant*.

Modem Use IRQ

This field sets the IRQ used by the Modem. By default, the setting is **3**.

Suspend Mode

When enabled, and after the set time of system inactivity, all devices except the CPU will be shut off.

HDD Power Down

When enabled, and after the set time of system inactivity, the hard disk drive will be powered down while all other devices remain active.

Soft-Off by PWRBTN

This field defines the power-off mode when using an ATX power supply. The *Instant Off* mode allows powering off immediately upon pressing the power button. In the *Delay 4 Sec* mode, the system powers off when the power button is pressed for more than four seconds or enters the suspend mode when pressed for less than 4 seconds.

CPU THRM-Throttling

When the system enters Doze mode, the CPU clock runs only part of the time. You may select the percent of time that the clock runs.

Wake Up by PCI card

The default setting is *Disabled*.

Power On by Ring

The default setting is *Disabled*.

Resume by Alarm

This field enables or disables the resumption of the system operation. When enabled, the user is allowed to set the *Date* and *Time*.

Reload Global Timer Events

The HDD, FDD, COM, LPT Ports, and PCI PIRQ are I/O events that can prevent the system from entering a power saving mode or can awaken the system from such a mode. When an I/O device wants to gain the attention of the operating system, it signals this by causing an IRQ to occur. When the operating system is ready to respond to the request, it interrupts itself and performs the service.

PNP/PCI Configurations

This option configures the PCI bus system. All PCI bus systems on the system use INT#, thus all installed PCI cards must be set to this value.

Phoenix - AwardBIOS CMOS Setup Utility
PnP/PCI Configurations

		ITEM HELP
Init Display First	PCI Slot	
Reset Configuration Data	Disabled	
Resources Controlled By	Auto (ESCD)	Menu Level >
IRQ Resources	Press Enter	
PCI/VGA Palette Snoop	Disabled	
INT Pin 1 Assignment	Auto	
INT Pin 2 Assignment	Auto	
INT Pin 3 Assignment	Auto	
INT Pin 4 Assignment	Auto	
INT Pin 5 Assignment	Auto	
INT Pin 6 Assignment	Auto	
INT Pin 7 Assignment	Auto	
INT Pin 8 Assignment	Auto	
PCI Express relative items		
Maximum Payload Size	128	

Init Display First

The default setting is *PCI Card*.

Reset Configuration Data

The default value is *Disabled*.

Resources Controlled by

This PnP BIOS can configure all of the boot and compatible devices with the use of a PnP operating system such as Windows 95.

PCI/VGA Palette Snoop

Some non-standard VGA display cards may not show colors properly. This field allows you to set whether or not MPEG ISA/VESA VGA cards can work with PCI/VGA. When this field is enabled, a PCI/VGA can work with an MPEG ISA/VESA VGA card. When this field is disabled, a PCI/VGA cannot work with an MPEG ISA/VESA card.

Maximum Payload Size

The default setting of the PCI Express Maximum Payload Size is 128.

PC Health Status

Phoenix - AwardBIOS CMOS Setup Utility
PC Health Status

Shutdown Temperature	Disabled	ITEM HELP
CPU Warning Temperature	Disabled	
System Temp	32°C/89°F	Menu Level >
CPU Temp	39°C/102°F	
System Fan Speed	4000 RPM	
CPU Fan Speed	4000 RPM	
Vcore	1.24 V	
12 V	12.03 V	
1.8 V	1.92 V	
5 V	4.99 V	
3.3 V	3.15 V	
VBAT (V)	3.13 V	
5VSB(V)	5.29 V	

CPU Warning Temperature

This field allows the user to set the temperature so that when the temperature is reached, the system sounds a warning. This function can help prevent damage to the system that is caused by overheating.

Shutdown Temperature

This field allows the user to set the temperature by which the system automatically shuts down once the threshold temperature is reached. This function can help prevent damage to the system that is caused by overheating.

Temperatures/Fan Speeds/Voltages

These fields are the parameters of the hardware monitoring function feature of the board. The values are read-only values as monitored by the system and show the PC health status.

Frequency/Voltage Control

Phoenix - AwardBIOS CMOS Setup Utility
Frequency/Voltage Control

CPU Clock Ratio Unlock	Disabled	ITEM HELP
CPU Clock Ratio	8x	Menu Level >
Auto Detect PCI Clk	Disabled	
Spread Spectrum	Disabled	
CPU Host / SRC / PCI Clock	Default	

CPU Clock Ratio Unlock

This field has a default setting of Disabled. When enabled, it allows the CPU clock ratio setting in the next field to be changed to a 'lower' ratio.

Auto Detect PCI Clk

This field enables or disables the auto detection of the PCI clock.

Spread Spectrum

This field sets the value of the spread spectrum. The default setting is *Disabled*. This field is for CE testing use only.

CPU Host / SRC / PCI Clock

This field has a default setting of *Default*.

Load Fail-Safe Defaults

This option allows you to load the troubleshooting default values permanently stored in the BIOS ROM. These default settings are non-optimal and disable all high-performance features.

Load Optimized Defaults

This option allows you to load the default values to your system configuration. These default settings are optimal and enable all high performance features.

Set Supervisor/User Password

These two options set the system password. Supervisor Password sets a password that will be used to protect the system and Setup utility. User Password sets a password that will be used exclusively on the system. To specify a password, highlight the type you want and press <Enter>. The Enter Password: message prompts on the screen. Type the password, up to eight characters in length, and press <Enter>. The system confirms your password by asking you to type it again. After setting a password, the screen automatically returns to the main screen.

To disable a password, just press the <Enter> key when you are prompted to enter the password. A message will confirm the password to be disabled. Once the password is disabled, the system will boot and you can enter Setup freely.

Save & Exit Setup

This option allows you to determine whether or not to accept the modifications. If you type “Y”, you will quit the setup utility and save all changes into the CMOS memory. If you type “N”, you will return to Setup utility.

Exit Without Saving

Select this option to exit the Setup utility without saving the changes you have made in this session. Typing “Y” will quit the Setup utility without saving the modifications. Typing “N” will return you to Setup utility.

Drivers Installation

This section describes the installation procedures for software and drivers under the Windows 2000 and Windows XP. The software and drivers are included with the board. If you find the items missing, please contact the vendor where you made the purchase. The contents of this section include the following:

Intel Q965 Chipset Software Installation Utility.....	46
Intel Q965 Chipset Graphics Driver.....	48
Realtek Codec Audio Driver Installation	50
Intel LAN Drivers Installation	51

IMPORTANT NOTE:

After installing your Windows operating system (Windows 2000/XP), you must install first the Intel Chipset Software Installation Utility before proceeding with the drivers installation.

Intel Q965 Chipset Software Installation Utility

The Intel® Q965 Chipset Drivers should be installed first before the software drivers to enable Plug & Play INF support for Intel chipset components. Follow the instructions below to complete the installation under Windows 2000/XP. (Before installed Intel Chipset Software Installation Utility, Please update your system to Windows 2000 SP4 or Windows XP SP1A)

1. Insert the CD that comes with the board and the screen below would appear. Click **Intel (R) Q965 Chipset Drivers**, then **Intel(R) Chipset Software Installation Utility**.



2. When the Welcome screen appears, click **Next** to continue.

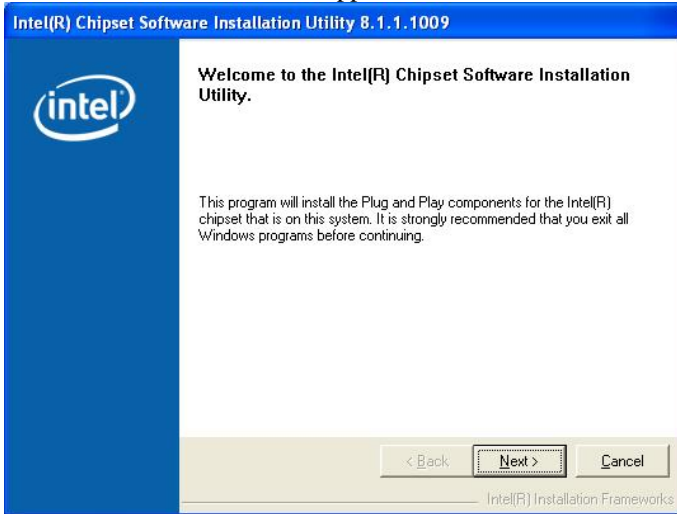

3. Click **Yes** to accept the software license agreement and proceed with the installation process.

4. On the Readme Information screen, click **Next** to continue the installation.

5. The Setup process is now complete. Click **Finish** to restart the computer and for changes to take effect.

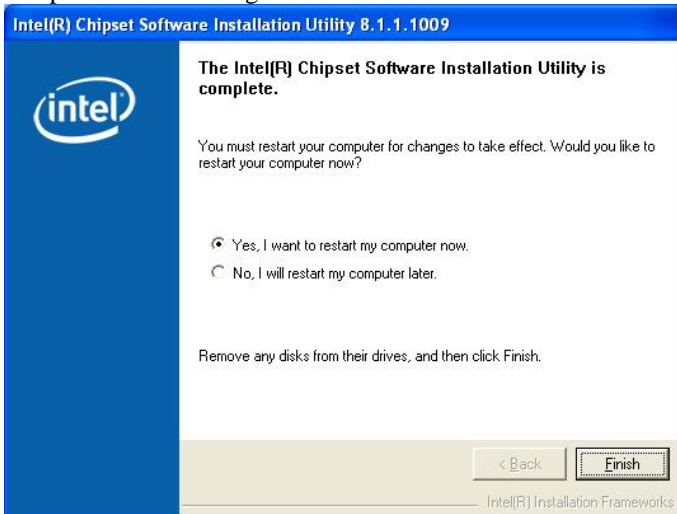

Intel Q965 Chipset Graphics Driver

Follow the instructions below to complete the installation under Windows 2000/XP.

1. Insert the CD that comes with the board and the screen below would appear. Click **Intel (R) Q965 Chipset Drivers**, then **Intel (R) Q965 Chipset Family Graphics Driver**.

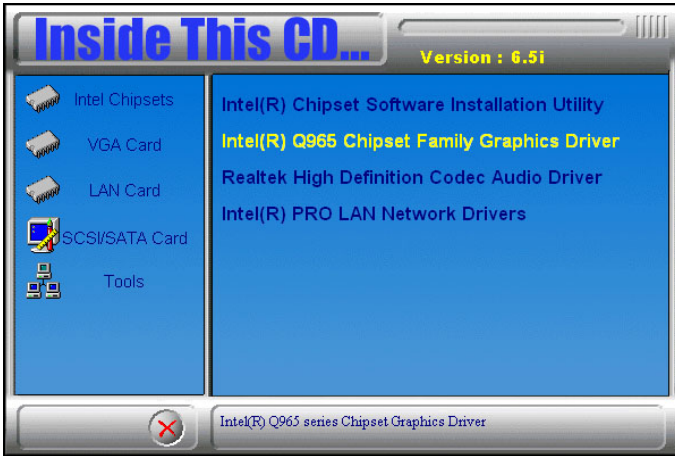

2. When the Welcome screen appears, click **Next** to continue.

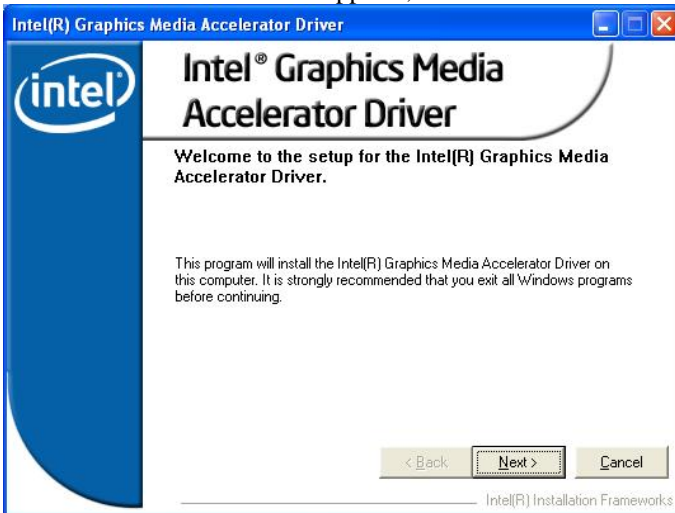

3. Click **Yes** to accept the software license agreement and proceed with the installation process.

4. On Readme File Information screen, click **Next** to continue.

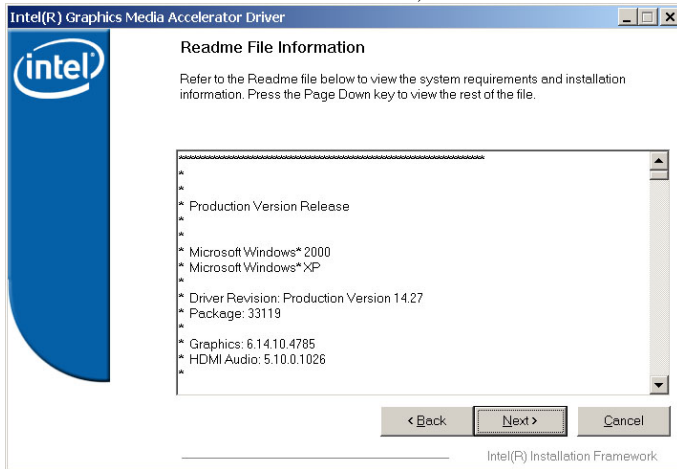

5. On Setup Progress screen, click **Next** to continue the installation.

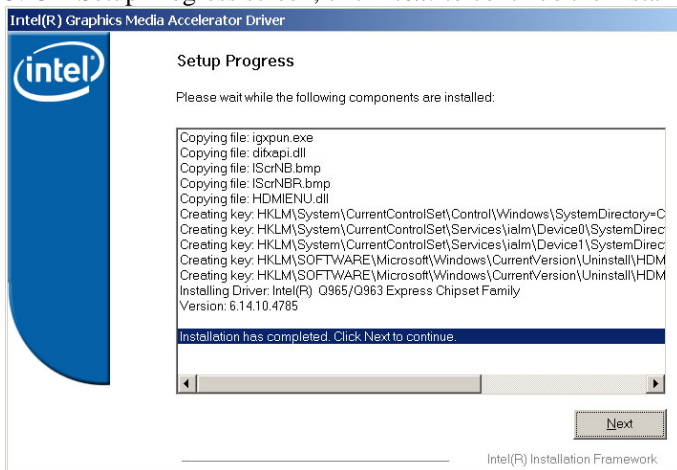

6. The Setup process is now complete. Click **Finish** to restart the computer and for changes to take effect.

Realtek Codec Audio Driver Installation

1. Insert the CD that comes with the board and the screen below would appear. Click **Intel (R) Q965 Chipset Drivers**, then **Realtek High Definition Codec Audio Driver**.



2. When the Welcome screen appears, click **Next** to continue.

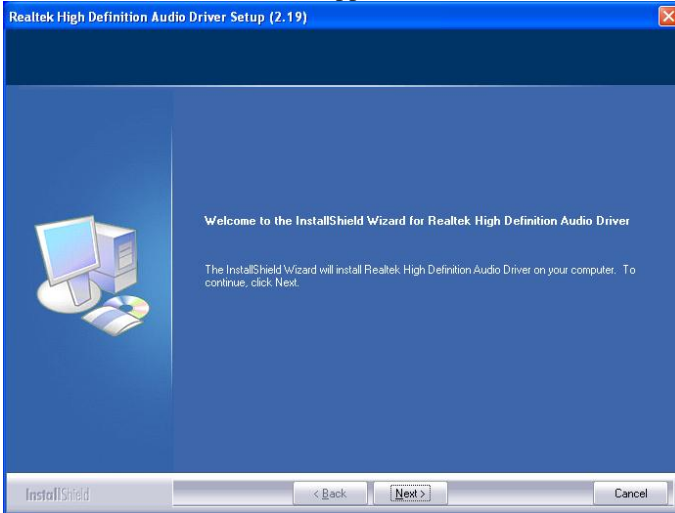

3. The Setup process is now complete. Restart the computer when prompted for changes to take effect.

Intel LAN Drivers Installation

Follow the steps below to start installing the Intel PCI Express Gigabit LAN drivers.

1. Insert the CD that comes with the board. On the initial screen, Click *Intel (R) Q965 Chipset Drivers*, then *Intel(R) PRO LAN Network Drivers*.



2. On the next screen, click *Install Drivers* to start the drivers installation.

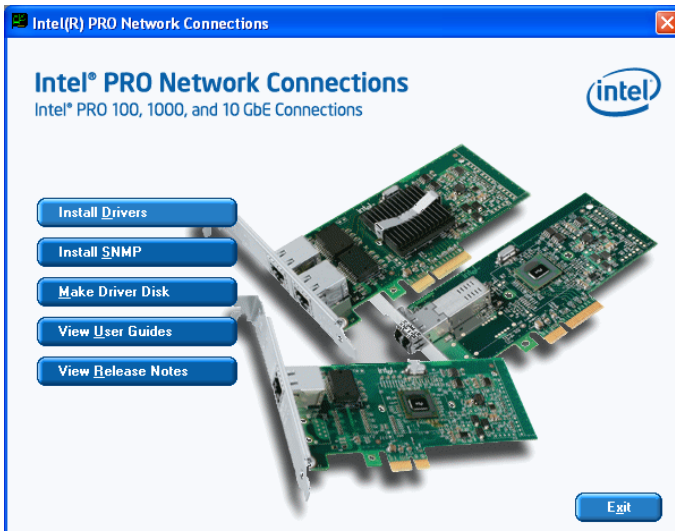

3. When the Welcome screen appears, click *Next* to continue.
4. In the License Agreement screen, click ***I accept the terms in license agreement*** and *Next* to accept the software license agreement and proceed with the installation process.
5. When the Setup Type screen appears, click ***Complete*** and *Next* to continue.

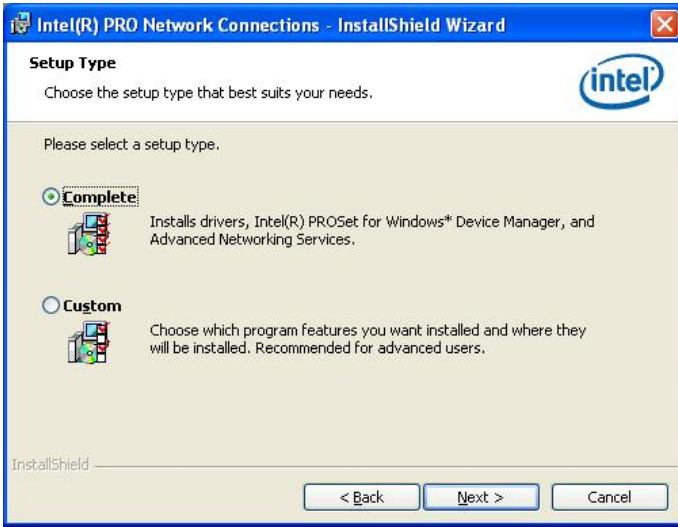

6. When the Ready to Install the Program screen appears, click ***Install*** to continue.
7. The Setup process is now complete (InstallShield Wizard Completed). Click ***Finish*** to restart the computer and for changes to take effect.

Appendix

A. I/O Port Address Map

Each peripheral device in the system is assigned a set of I/O port addresses that also becomes the identity of the device. The following table lists the I/O port addresses used.

Address	Device Description
000h - 01Fh	DMA Controller #1
020h - 03Fh	Interrupt Controller #1
040h - 05Fh	Timer
060h - 06Fh	Keyboard Controller
070h - 07Fh	Real Time Clock, NMI
080h - 09Fh	DMA Page Register
0A0h - 0BFh	Interrupt Controller #2
0C0h - 0DFh	DMA Controller #2
0F0h	Clear Math Coprocessor Busy Signal
0F1h	Reset Math Coprocessor
1F0h - 1F7h	IDE Interface
278h - 27Fh	Parallel Port #2(LPT2)
2F8h - 2FFh	Serial Port #2(COM2)
2B0h - 2DFh	Graphics adapter Controller
378h - 3FFh	Parallel Port #1(LPT1)
360h - 36Fh	Network Ports
3B0h - 3BFh	Monochrome & Printer adapter
3C0h - 3CFh	EGA adapter
3D0h - 3DFh	CGA adapter
3F0h - 3F7h	Floppy Disk Controller
3F8h - 3FFh	Serial Port #1(COM1)

B. Interrupt Request Lines (IRQ)

Peripheral devices use interrupt request lines to notify CPU for the service required. The following table shows the IRQ used by the devices on board.

Level	Function
IRQ0	System Timer Output
IRQ1	Keyboard
IRQ2	Interrupt Cascade
IRQ3	Serial Port #2
IRQ4	Serial Port #1
IRQ5	Reserved
IRQ6	Floppy Disk Controller
IRQ7	Parallel Port #1
IRQ8	Real Time Clock
IRQ9	Reserved
IRQ10	Reserved
IRQ11	Reserved
IRQ12	PS/2 Mouse
IRQ13	80287
IRQ14	Primary IDE
IRQ15	Secondary IDE

C. Watchdog Timer Configuration

The WDT is used to generate a variety of output signals after a user programmable count. The WDT is suitable for use in the prevention of system lock-up, such as when software becomes trapped in a deadlock. Under these sorts of circumstances, the timer will count to zero and the selected outputs will be driven. Under normal circumstance, the user will restart the WDT at regular intervals before the timer counts to zero.

SAMPLE CODE:

```
//=====
//
// THIS CODE AND INFORMATION IS PROVIDED "AS IS" WITHOUT WARRANTY OF ANY
// KIND, EITHER EXPRESSED OR IMPLIED, INCLUDING BUT NOT LIMITED TO THE
// IMPLIED WARRANTIES OF MERCHANTABILITY AND/OR FITNESS FOR A PARTICULAR
// PURPOSE.
//
//=====
=====
#include <stdio.h>
#include <stdlib.h>
#include "W627EHF.H"
//=====
=====
int main (int argc, char *argv[]);
void copyright(void);
void EnableWDT(int);
void DisableWDT(void);
//=====
=====
int main (int argc, char *argv[])
{
    unsigned char bBuf;
    unsigned char bTime;
    char **endptr;

    copyright();

    if (argc != 2)
    {
        printf(" Parameter incorrect!!\n");
        return 1;
    }

    if (Init_W627EHF() == 0)
    {
        printf(" Winbond 83627HF is not detected, program abort.\n");
        return 1;
    }
    bTime = strtol (argv[1], endptr, 10);
```

```

    printf("System will reset after %d seconds\n", bTime);

    EnableWDT(bTime);

    return 0;
}
//=====
void copyright(void)
{
    printf("\n===== Winbond 83627EHF Watch Timer Tester (AUTO DETECT)
=====\\n\\n
        \" Usage : W627E_WD reset_time\\n\\n
        \" Ex : W627E_WD 3 => reset system after 3 second\\n\\n
        \" W627E_WD 0 => disable watch dog timer\\n\\n");
}
//=====
void EnableWDT(int interval)
{
    unsigned char bBuf;

    bBuf = Get_W627EHF_Reg( 0x2D);
    bBuf &= (!0x01);
    Set_W627EHF_Reg( 0x2D, bBuf); //Enable WDTO

    Set_W627EHF_LD( 0x08); //switch to logic device 8
    Set_W627EHF_Reg( 0x30, 0x01); //enable timer

    bBuf = Get_W627EHF_Reg( 0xF5);
    bBuf &= (!0x08);
    Set_W627EHF_Reg( 0xF5, bBuf); //count mode is second

    Set_W627EHF_Reg( 0xF6, interval); //set timer
}
//=====
void DisableWDT(void)
{
    Set_W627EHF_LD(0x08); //switch to logic device 8
    Set_W627EHF_Reg(0xF6, 0x00); //clear watchdog timer
    Set_W627EHF_Reg(0x30, 0x00); //watchdog disabled
}
//=====

```

```

//=====
//
// THIS CODE AND INFORMATION IS PROVIDED "AS IS" WITHOUT WARRANTY OF ANY
// KIND, EITHER EXPRESSED OR IMPLIED, INCLUDING BUT NOT LIMITED TO THE
// IMPLIED WARRANTIES OF MERCHANTABILITY AND/OR FITNESS FOR A PARTICULAR
// PURPOSE.
//
//=====
=====
#include "W627EHF.H"
#include <dos.h>
//=====
=====
unsigned int W627EHF_BASE;
void Unlock_W627EHF (void);
void Lock_W627EHF (void);
//=====
unsigned int Init_W627EHF(void)
{
    unsigned int result;
    unsigned char ucDid;

    W627EHF_BASE = 0x2E;
    result = W627EHF_BASE;

    ucDid = Get_W627EHF_Reg(0x20);
    if (ucDid == 0x88)
    {   goto Init_Finish;   }

    W627EHF_BASE = 0x4E;
    result = W627EHF_BASE;
    ucDid = Get_W627EHF_Reg(0x20);
    if (ucDid == 0x88)
    {   goto Init_Finish;   }

    W627EHF_BASE = 0x00;
    result = W627EHF_BASE;

Init_Finish:
    return (result);
}
//=====
void Unlock_W627EHF (void)
{
    outportb(W627EHF_INDEX_PORT, W627EHF_UNLOCK);
    outportb(W627EHF_INDEX_PORT, W627EHF_UNLOCK);
}
//=====
=====
void Lock_W627EHF (void)
{
    outportb(W627EHF_INDEX_PORT, W627EHF_LOCK);
}
//=====
void Set_W627EHF_LD( unsigned char LD)
{
    Unlock_W627EHF();
    outportb(W627EHF_INDEX_PORT, W627EHF_REG_LD);
    outportb(W627EHF_DATA_PORT, LD);
}

```

```

    Lock_W627EHF();
}
//=====
void Set_W627EHF_Reg( unsigned char REG, unsigned char DATA)
{
    Unlock_W627EHF();
    outportb(W627EHF_INDEX_PORT, REG);
    outportb(W627EHF_DATA_PORT, DATA);
    Lock_W627EHF();
}
//=====
unsigned char Get_W627EHF_Reg(unsigned char REG)
{
    unsigned char Result;
    Unlock_W627EHF();
    outportb(W627EHF_INDEX_PORT, REG);
    Result = inportb(W627EHF_DATA_PORT);
    Lock_W627EHF();
    return Result;
}
//=====

//=====
//
// THIS CODE AND INFORMATION IS PROVIDED "AS IS" WITHOUT WARRANTY OF ANY
// KIND, EITHER EXPRESSED OR IMPLIED, INCLUDING BUT NOT LIMITED TO THE
// IMPLIED WARRANTIES OF MERCHANTABILITY AND/OR FITNESS FOR A PARTICULAR
// PURPOSE.
//
//=====
#ifndef __W627EHF_H
#define __W627EHF_H        1
//=====
#define W627EHF_INDEX_PORT    (W627EHF_BASE)
#define W627EHF_DATA_PORT    (W627EHF_BASE+1)
//=====
#define W627EHF_REG_LD        0x07
//=====
#define W627EHF_UNLOCK        0x87
#define W627EHF_LOCK          0xAA
//=====
unsigned int Init_W627EHF(void);
void Set_W627EHF_LD( unsigned char);
void Set_W627EHF_Reg( unsigned char, unsigned char);
unsigned char Get_W627EHF_Reg( unsigned char);
//=====
#endif    //__W627EHF_H

```

D. Digital I/O Sample Code

```

Filename: W627hf.h
//=====================================================
//
// THIS CODE AND INFORMATION IS PROVIDED "AS IS" WITHOUT WARRANTY OF ANY
// KIND, EITHER EXPRESSED OR IMPLIED, INCLUDING BUT NOT LIMITED TO THE
// IMPLIED WARRANTIES OF MERCHANTABILITY AND/OR FITNESS FOR A PARTICULAR
// PURPOSE.
//
//=====================================================
#ifndef __W627HF_H
#define __W627HF_H                1
//=====================================================
#define W627HF_INDEX_PORT        (W627HF_BASE)
#define W627HF_DATA_PORT         (W627HF_BASE+1)
//=====================================================
#define W627HF_REG_LD             0x07
//=====================================================
#define W627HF_UNLOCK            0x87
#define W627HF_LOCK              0xAA
//=====================================================
unsigned int Init_W627HF(void);
void Set_W627HF_LD( unsigned char);
void Set_W627HF_Reg( unsigned char, unsigned char);
unsigned char Get_W627HF_Reg( unsigned char);
//=====================================================
#endif    // __W627HF_H

```

Filename: W627hf.cpp

```
//=====
//
// THIS CODE AND INFORMATION IS PROVIDED "AS IS" WITHOUT WARRANTY OF ANY
// KIND, EITHER EXPRESSED OR IMPLIED, INCLUDING BUT NOT LIMITED TO THE
// IMPLIED WARRANTIES OF MERCHANTABILITY AND/OR FITNESS FOR A PARTICULAR
// PURPOSE.
//
//=====
unsigned int W627HF_BASE;
void Unlock_W627HF (void);
void Lock_W627HF (void);
//=====
unsigned int Init_W627HF(void)
{
    unsigned int result;    //0=NA, 1=627HF, 2=627THF, 4=627EHF

//    W627HF_BASE = 0x2E;
//    W627HF_BASE = 0x4E;
    result = Get_W627HF_Reg(0x20);
    if (result == 0x52)
    {
        result = 1;
        goto Init_Finish;
    }
    else if (result == 0x82)
    {
        result = 2;
        goto Init_Finish;
    }
    else if (result == 0x88)
    {
        result = 4;
        goto Init_Finish;
    }

//    W627HF_BASE = 0x4E;
//    W627HF_BASE = 0x2E;

    result = Get_W627HF_Reg(0x20);
    if (result == 0x52)
    {
        result = 1;
        goto Init_Finish;
    }
    else if (result == 0x82)
    {
        result = 2;
        goto Init_Finish;
    }
    else if (result == 0x88)
    {
        result = 4;
        goto Init_Finish;
    }
}
```

```

        W627HF_BASE = 0x00;
        result = 0;

Init_Finish:
    return (result);
}
//=====
void Unlock_W627HF (void)
{
    outportb(W627HF_INDEX_PORT, W627HF_UNLOCK);
    outportb(W627HF_INDEX_PORT, W627HF_UNLOCK);
}
//=====
void Lock_W627HF (void)
{
    outportb(W627HF_INDEX_PORT, W627HF_LOCK);
}
//=====
void Set_W627HF_LD( unsigned char LD)
{
    Unlock_W627HF();
    outportb(W627HF_INDEX_PORT, W627HF_REG_LD);
    outportb(W627HF_DATA_PORT, LD);
    Lock_W627HF();
}
//=====
void Set_W627HF_Reg( unsigned char REG, unsigned char DATA)
{
    Unlock_W627HF();
    outportb(W627HF_INDEX_PORT, REG);
    outportb(W627HF_DATA_PORT, DATA);
    Lock_W627HF();
}
//=====
unsigned char Get_W627HF_Reg(unsigned char REG)
{
    unsigned char Result;
    Unlock_W627HF();
    outportb(W627HF_INDEX_PORT, REG);
    Result = inportb(W627HF_DATA_PORT);
    Lock_W627HF();
    return Result;
}
//=====

```

File of the Main.cpp

```
//=====
// THIS CODE AND INFORMATION IS PROVIDED "AS IS" WITHOUT WARRANTY OF ANY
// KIND, EITHER EXPRESSED OR IMPLIED, INCLUDING BUT NOT LIMITED TO THE
// IMPLIED WARRANTIES OF MERCHANTABILITY AND/OR FITNESS FOR A PARTICULAR
// PURPOSE.
//=====
#include <dos.h>
#include <conio.h>
#include <stdio.h>
#include <stdlib.h>
#include "W627HF.H"
//-----
void ClrKbBuf(void);
int main (void);
unsigned char GetDI(unsigned char);
void SetDo(unsigned char, unsigned char);
//-----
int main (void)
{
    unsigned char ucDO = 0;                //data for digital output
    unsigned char ucDI;                    //data for digital input
    unsigned char ucBuf;
    char SIO;

    SIO = Init_W627HF();
    if (SIO == 0)
    {
        printf("Can not detect Winbond 83627HF/83627THF/83627EHF, program abort.\n");
        return(1);
    }
    switch (SIO)
    { //-----
        case 1:
            printf("Winbond 83627HF is detected .\n");
            break;
            //-----
        case 2:
            printf("Winbond 83627THF is detected.\n");
            break;
            //-----
        case 4:
            printf("Winbond 83627EHF is detected.\n");
            break;
            //-----
    }

    //bit 0..3 = input signal
    //bit 4..7 = output signal

    ucDI = GetDI(0x0F);                    //get current DI status
    SetDo(ucDO, 0xF0);                    //set current DO status
    return 0;
}
//-----
unsigned char GetDI(unsigned char Mask)
{
```

```
    unsigned char result;

    Set_W627HF_LD(0x07); //switch to logic device 7
    Set_W627HF_Reg(0xF0, Mask); //set the DIO direction
    result = Get_W627HF_Reg(0xF1) & Mask;
    return (result);
}
//-----
void SetDo(unsigned char NewData, unsigned char Mask)
{
    Set_W627HF_LD(0x07); //switch to logic device 7
    Set_W627HF_Reg(0xF0, ~Mask); //set the DIO direction
    Set_W627HF_Reg(0xF1, NewData & Mask);
}
//-----
void ClrKbBuf(void)
{
    while(kbhit())
    {   getch();   }
}
//-----
```

This page is intentionally left blank.