

IB885

AMD Sempron™ 200U/ 210U
3.5-inch Embedded Board

USER'S MANUAL

Version 1.0

Acknowledgments

Award is a registered trademark of Award Software International, Inc.

PS/2 is a trademark of International Business Machines Corporation.

AMD Sempron™ 200U/210U are registered trademarks of AMD Corporation.

Microsoft Windows is a registered trademark of Microsoft Corporation.

Winbond is a registered trademark of Winbond Electronics Corporation.

All other product names or trademarks are properties of their respective owners.

Table of Contents

Introduction	1
Product Description.....	1
Checklist.....	2
IB885 Specifications	3
Board Dimensions	4
Installations	5
Installing the Memory	6
Setting the Jumpers	7
Connectors on IB885.....	11
BIOS Setup.....	21
Drivers Installation	39
SM Bus Controller Driver Installation	40
VGA Drivers Installation	43
Realtek Codec Audio Driver Installation	45
LAN Drivers Installation.....	46
Appendix	49
A. I/O Port Address Map.....	49
B. Interrupt Request Lines (IRQ)	50
C. Watchdog Timer Configuration.....	51

This page is intentionally left blank.

Introduction

Product Description

The IB885 3.5-inch embedded board incorporates the Mobile AMD M690E Express Chipset for Embedded Computing, consisting of the AMD M690E (North Bridge) and SB600 (South Bridge), an optimized integrated graphics solution with an 800MHz front-side bus. Dimensions of the board are 102mm x 148mm.

The M690E integrates an ATi Radeon X1200-based graphics engine supporting dual display, an LVDS interface, an integrated TMDS controller, and operates at core speeds of up to 400 MHz. IB885 features a low-power design, is validated with the AMD Sempron™. With one DDR2 800MHz SODIMM socket on board, the board supports up to 2GB of DDR2 system memory.

The main features of the board are:

- Supports AMD Sempron™ 200U (8W, 1.0G, DDR2-400) / 210U (15W 1.5G, DDR2-667), 256K cache
- Supports up to 800MHz FSB
- One DDR2 SDRAM SODIMM; Max. 2GB memory
- 2x Realtek PCI-Express Gigabit LAN
- AMD M690E Express VGA for CRT / LVDS / DVI
- 1x SATA, 4x USB 2.0, 2x COM, Watchdog timer
- Digital I/O, LPC/Smart battery interface

Checklist

Your IB885 package should include the items listed below.

- The IB885 embedded board
- This User's Manual
- 1 CD containing chipset drivers and flash memory utility
- Cables and heatsink (shown below) is optional.

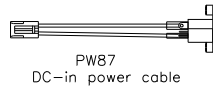
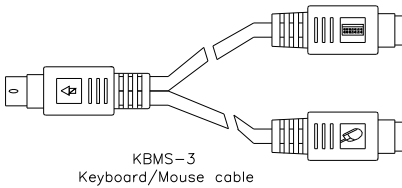
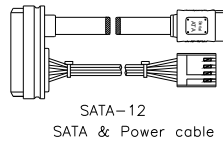
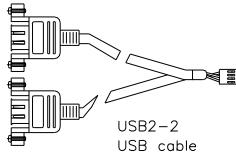
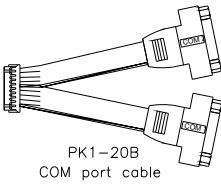
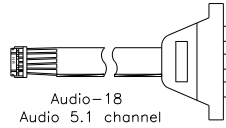
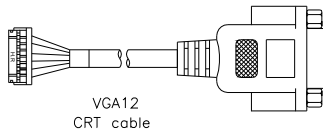
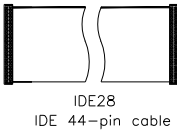

HSIB885-BGA1(+FAN)
Heatsink

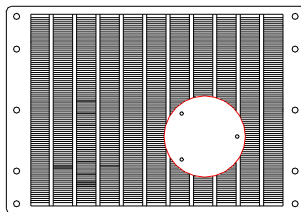

IB885 Specifications

Features

- Supports AMD Sempron 200U / 210U Processors
800MHz FSB, 1GHz~1.5GHz speed
- DDR2 SODIMM x 1, supports 2GB Max.
- Dual Realtek RTL8111C PCI-E Gigabit LAN
- AMD M690E built-in Radeon X1200 graphics,
DVI on board, Dual display supported
- 2x COM, 4x USB, 1x SATAII

System

CPU	AMD Sempron processors 1GHz ~ 1.5GHz, 800MHz FSB
System Memory	DDR2 SODIMM x 1, Max. 2GB, 400MHz/667MHz
System Chipset	AMD M690E + SB600
BIOS	Award
Watchdog Timer	256 levels
SSD	CF socket
H/W Monitor	Yes
Expansion Slot	None

Graphics

VGA Controller	AMD M690E built-in Radeon X1200 graphics Supports DVI edge connector and CRT via pin header
Dual Display	Available in combination of Analog/CRT, LVDS, onboard DVI, CRT via pin header

Ethernet

Controller	Dual Realtek RTL 8111C PCI-E Gigabit LAN
Connector	RJ-45 on board

Multi I/O

Chipset	Winbond W83627EHG 1x IDE, 1x KB, 1x Mouse 1x RS232, 1XRS232/422/485, 1x SATAII
USB	2 ports on board Pin header for 2 ports (USB 2.0)
Audio	Chipset built-in audio w/ ALC662 codec for 5.1CH
Others	12V DC-in, DC backlight control, smart battery interface

Mechanical and Environmental

Dimensions	102mm x 148mm (4" x 5.8")
Operating Temperature	0°C~60°C (32°F~140°F)
Storage Temperature	-20°C~80°C (-4°F~176°F)
Relative Humidity	10%~90% (non-condensing)

Board Dimensions

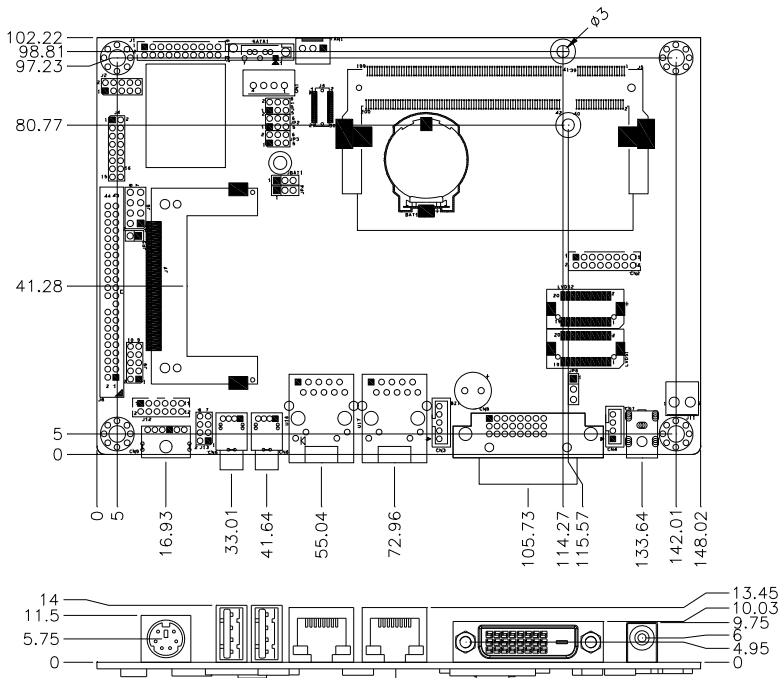

Top View

Installations

This section provides information on how to use the jumpers and connectors on the IB885 in order to set up a workable system. The topics covered are:

Installing the Memory	6
Setting the Jumpers.....	7
Connectors on IB885	11

Installing the Memory

The IB885 board supports one DDR2 memory socket that can support up to 2GB memory, DDR2 400/533/667 (w/o ECC function).

Installing and Removing Memory Modules

To install the DDR2 modules, locate the memory slot on the board and perform the following steps:

1. Hold the DDR2 module so that the key of the DDR2 module aligns with that on the memory slot. Insert the module into the socket at a slight angle (approximately 30 degrees). Note that the socket and module are both keyed, which means that the module can be installed only in one direction.
2. To seat the memory module into the socket, apply firm and even pressure to each end of the module until you feel it slip down into the socket.
3. With the module properly seated in the socket, rotate the module downward. Continue pressing downward until the clips at each end lock into position.
4. To remove the DDR2 module, press the clips with both hands.

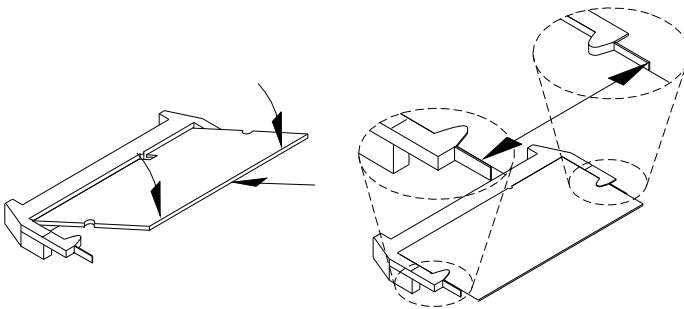

Setting the Jumpers

Jumpers are used on IB885 to select various settings and features according to your needs and applications. Contact your supplier if you have doubts about the best configuration for your needs. The following lists the connectors on IB885 and their respective functions.

Jumper Locations on IB885.....	8
JP1, JP2, JP3: RS232/422/485 (COM2) Selection	9
JBAT1: Clear CMOS Setting	9
JP4: ATX or AT Power Selection	9
JP5: CompactFlash Slave/Master Selection	10
JP6: LCD Panel Power Selection	10

Jumper Locations on IB885

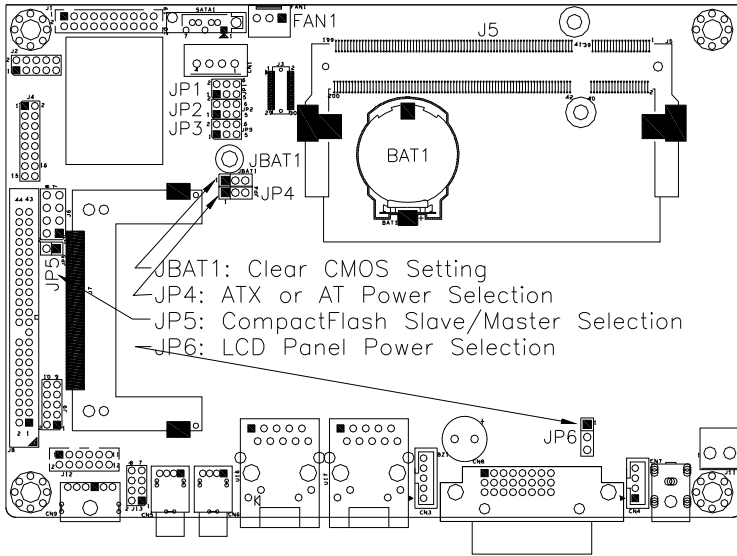

Jumpers on IB885	Page
JP1, JP2, JP3: RS232/422/485 (COM2) Selection	9
JBAT1: Clear CMOS Setting.....	9
JP4: ATX or AT Power Selection.....	9
JP5: CompactFlash Slave/Master Selection.....	10
JP6: LCD Panel Power Selection.....	10

JP1, JP2, JP3: RS232/422/485 (COM2) Selection

COM1 is fixed for RS-232 use only. COM2 is selectable for RS232, RS-422 and RS-485. The following describes the settings for COM2.

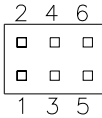

COM2 Function	RS-232	RS-422	RS-485
Jumper Setting (pin closed)	JP3: 1-2	JP3: 3-4	JP3: 5-6
	JP2: 3-5 & 4-6	JP2: 1-3 & 2-4	JP2: 1-3 & 2-4
	JP1: 3-5 & 4-6	JP1: 1-3 & 2-4	JP1: 1-3 & 2-4

COM2 is jumper selectable for RS-232, RS-422 and RS-485.

Pin #	Signal Name		
	RS-232	RS-422	RS-485
11	DCD	TX-	DATA-
13	RX	TX+	DATA+
15	TX	RX+	NC
17	DTR	RX-	NC
19	Ground	Ground	Ground
12	DSR	NC	NC
14	RTS	NC	NC
16	CTS	NC	NC
18	RI	NC	NC
20	NC	NC	NC



JBAT1: Clear CMOS Setting

JBAT1	Setting
 1 2 3	Normal
 1 2 3	Clear CMOS



JP4: ATX or AT Power Selection

JP4	ATX Power
 1 2 3	ATX
 1 2 3	AT

JP5: CompactFlash Slave/Master Selection

JP5	CF Setting
 Short	Master
 Open	Slave

JP6: LCD Panel Power Selection

JP6	LCD Panel Power
 1 2 3	3.3V
 1 2 3	5V

Connectors on IB885

Connector Locations on IB885.....	12
CN9: PS/2 Keyboard/Mouse Connector.....	13
CN5, CN6: USB2/3 Ports.....	13
U16, U17: GbE RJ45 Ports	13
CN8: DVI-D Connector	13
CN7, J11: DC-IN 12V Power Connector	13
FAN1: System Fan Power Connector	14
IDE1: IDE Connector	14
LVDS1, LVDS2: LVDS Connectors (1st/2nd channel).....	14
SATA1: SATA Connector	15
CN1: HDD Power Connector.....	15
CN2: VGA Connector (DF11)	15
CN3: Smart Battery Interface Connector	16
CN4: LCD Backlight Connector (DC type)	16
J1: COM1, COM2 Serial Port	16
J2: Digital I/O.....	17
J4: For LPC I/F Adaptor Card	17
ID394 with Fintek F81216, 2 or 4 Serial Ports	17
ID395 Winbond WPCT200 x1 for TPM1.2.....	17
J6: System Function Connector.....	18
J7: CF Socket.....	19
J9: SPI Flash Connector (factory use only).....	19
J12: Audio Connector.....	19
J13: USB0/USB1 Connector	19

Connector Locations on IB885

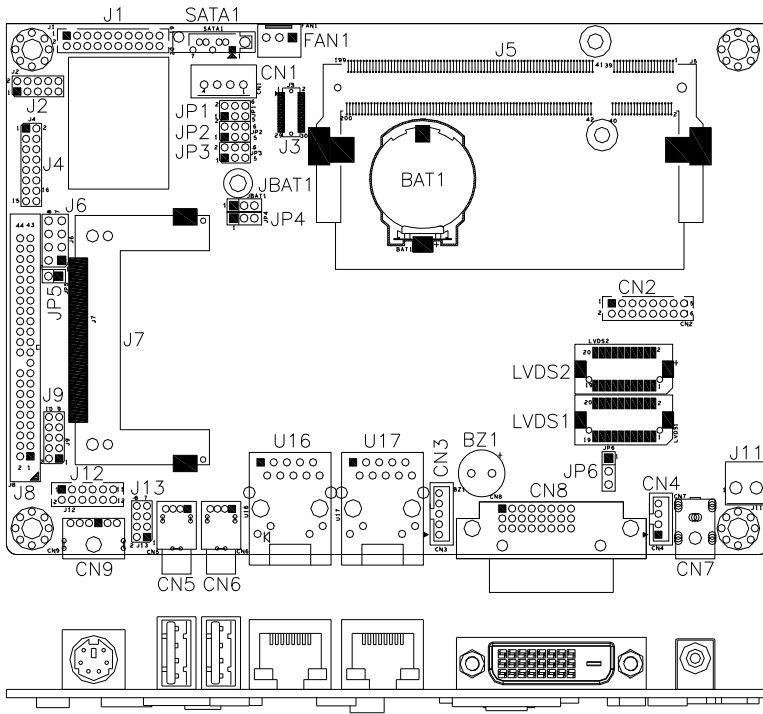

Connector Locations on IB885

CN9: PS/2 Keyboard/Mouse Connector	13
CN5, CN6: USB2/3 Ports	13
U16, U17: GbE RJ45 Ports.....	13
CN8: DVI-D Connector.....	13
CN7, J11: DC-IN 12V Power Connector	13
FAN1: System Fan Power Connector.....	14
IDE1: IDE Connector	14
LVDS1, LVDS2: LVDS Connectors (1st/2nd channel)	14
SATA1: SATA Connector.....	15
CN1: HDD Power Connector	15
CN2: VGA Connector (DF11).....	15
CN3: Smart Battery Interface Connector	16
CN4: LCD Backlight Connector (DC type)	16
J1: COM1, COM2 Serial Port	16
J2: Digital I/O	17
J4: For LPC I/F Adaptor Card	17
ID394 with Fintek F81216, 2 or 4 Serial Ports	17
ID395 Winbond WPCT200 x1 for TPM1.2.....	17
J6: System Function Connector	18
J7: CF Socket.....	19
J9: SPI Flash Connector (factory use only).....	19
J12: Audio Connector.....	19
J13: USB0/USB1 Connector	19

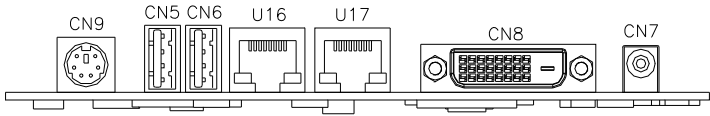

CN9: PS/2 Keyboard/Mouse Connector



Pin #	Signal Name
1	Keyboard data
2	Mouse data
3	GND
4	5V
5	Keyboard clock
6	Mouse clock

CN5, CN6: USB2/3 Ports

U16, U17: GbE RJ45 Ports

CN8: DVI-D Connector

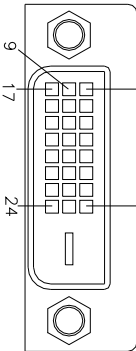

Signal Name	Pin #	Pin #	Signal Name
DATA 2-	1	16	HOT POWER
DATA 2+	2	17	DATA 0-
Shield 2/4	3	18	DATA 0+
DATA 4-	4	19	SHIELD 0/5
DATA 4+	5	20	DATA 5-
DDC CLOCK	6	21	DATA 5+
DDC DATA	7	22	SHIELD CLK
VSYNC	8	23	CLOCK -
DATA 1-	9	24	CLOCK +
DATA 1+	10	C1	N.C.
SHIELD 1/3	11	C2	N.C.
DATA 3-	12	C3	N.C.
DATA 3+	13	C4	N.C.
DDC POWER	14	C5	N.C.
A GROUND 1	15	C6	N.C.

CN7, J11: DC-IN 12V Power Connector

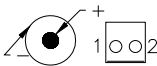

Pin #	Signal Name
1	DC in (12V only)
2	Ground

FAN1: System Fan Power Connector

FAN1 is a 3-pin header for system fans. The fan must be a 12V (500mA).



Pin #	Signal Name
1	Ground
2	+12V
3	Rotation detection

IDE1: IDE Connector

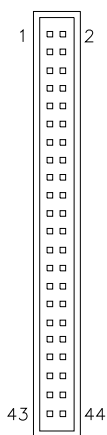

Signal Name	Pin #	Pin #	Signal Name
Reset IDE	1	2	Ground
Host data 7	3	4	Host data 8
Host data 6	5	6	Host data 9
Host data 5	7	8	Host data 10
Host data 4	9	10	Host data 11
Host data 3	11	12	Host data 12
Host data 2	13	14	Host data 13
Host data 1	15	16	Host data 14
Host data 0	17	18	Host data 15
Ground	19	20	Key
DRQ0	21	22	Ground
Host IOW	23	24	Ground
Host IOR	25	26	Ground
IOCHRDY	27	28	Host ALE
DACK0	29	30	Ground
IRQ14	31	32	No connect
Address 1	33	34	No connect
Address 0	35	36	Address 2
Chip select 0	37	38	Chip select 1
Activity	39	40	Ground
Vcc	41	42	Vcc
Ground	43	44	N.C.

LVDS1, LVDS2: LVDS Connectors (1st/2nd channel)

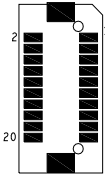

Signal Name	Pin #	Pin #	Signal Name
TX0-	2	1	TX0+
Ground	4	3	Ground
TX1-	6	5	TX1+
*5V/3.3V	8	7	Ground
TX3-	10	9	TX3+
TX2-	12	11	TX2+
Ground	14	13	Ground
TXC-	16	15	TXC+
*5V/3.3V	18	17	ENABKL
+12V	20	19	+12V

*JP6 can be used to set 3.3V or 5V.

SATA1: SATA Connector

CN1: HDD Power Connector



Pin #	Signal Name
1	+5V
2	Ground
3	Ground
4	+12V

CN2: VGA Connector (DF11 Connector)

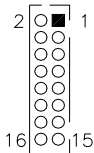

Signal Name	Pin	Pin	Signal Name
+5V	2	1	Red
Ground	4	3	Green
N.C	6	5	Blue
DDCDATA	8	7	N.C
H_SYNC	10	9	GND
V_SYNC	12	11	GND
DDCCLK	14	13	GND
N.C.	16	15	GND

CN3: Smart Battery Interface Connector



Pin #	Signal Name
1	RST
2	EXTSMI
3	Ground
4	DATA
5	CLK

CN4: LCD Backlight Connector (DC type)

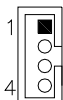

Pin #	Signal Name
1	+12V
2	Backlight Enable
3	*Backlight Adj (DC type)
4	Ground

* LCD backlight can be controlled by the OS.

J1: COM1, COM2 Serial Port (DF11 Connector)

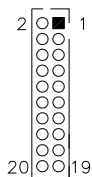

Signal Name	Pin #	Pin #	Signal Name
DSR1 Data set ready	2	1	DCD1 Data carrier detect
RTS1 Request to send	4	3	RXD1 Receive data
CTS1 Clear to send	6	5	TXD1 Transmit data
RI1 Ringing indicator	8	7	DTR1 Data terminal ready
Not used	10	9	Ground
DSR2	12	11	DCD2
RTS2	14	13	RXD2
CTS2	16	15	TXD2
RI2	18	17	DTR2
Not used	20	19	Ground

J2: Digital I/O



Signal Name	Pin	Pin	Signal Name
GND	1	2	VCC
OUT3	3	4	OUT1
OUT2	5	6	OUT0
IN3	7	8	IN1
IN2	9	10	IN0

J4: For LPC I/F Adaptor Card

ID394 with Fintek F81216, 2 or 4 Serial Ports

ID395 Winbond WPCT200 x1 for TPM1.2

ID395 Winbond WPCT200 for TPM1.2

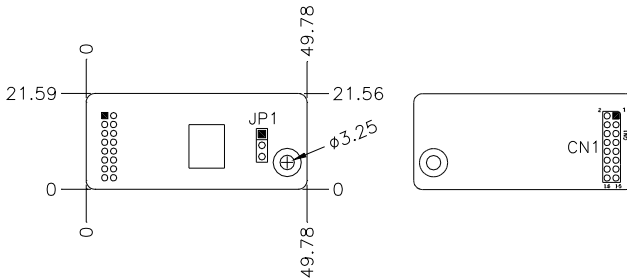

CN1: LPC I/F connectors

Package list

Nylon Nut x1; Screw x2; Washer x2

ID394 LPC Serial Ports Adaptor Card

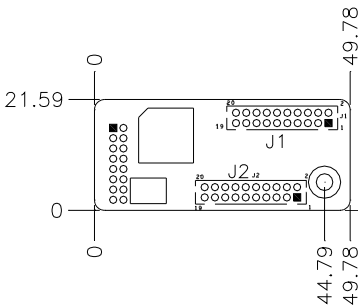

J1 J2: COM3/4/5/6 Serial Ports

J1 - COM3/4 pin-header connector.

Pin1~Pin10 COM3

Pin11~Pin20 COM4

J2 - COM5/6 pin-header connector.

Pin1~Pin10 COM5

Pin11~Pin20 COM6

Signal Name	Pin #	Pin #	Signal Name
DCD, Data carrier detect	1	2	DSR, Data set ready
RXD, Receive data	3	4	RTS, Request to send
TXD, Transmit data	5	6	CTS, Clear to send
DTR, Data terminal ready	7	8	RI, Ring indicator
GND, ground	9	10	Not Used
DCD, Data carrier detect	11	12	DSR, Data set ready
RXD, Receive data	13	14	RTS, Request to send
TXD, Transmit data	15	16	CTS, Clear to send
DTR, Data terminal ready	17	18	RI, Ring indicator
GND, ground	19	20	Not Used

CN1: LPC I/F connectors

Package list:

COM port cable (PK1-20B) x2; Nylon Nut x1;

Screw x2; Washer x2

J6: System Function Connector



ATX Power ON Switch: Pins 1 and 2

This 2-pin connector is an “ATX Power Supply On/Off Switch” on the system that connects to the power switch on the case. When pressed, the power switch will force the system to power on. When pressed again, it will force the system to power off.

Power LED: Pins 3 and 4

Pin #	Signal Name
3	Vcc
4	Ground

Hard Disk Drive LED Connector: Pins 5 and 6

This connector connects to the hard drive activity LED on control panel. This LED will flash when the HDD is being accessed.

Pin #	Signal Name
6	HDD Active
5	Vcc

Reset Switch: Pins 7 and 8

The reset switch allows the user to reset the system without turning the main power switch off and then on again.

J7: CF Socket

J9: SPI Flash Connector (factory use only)

J12: Audio Connector (DF11 Connector)

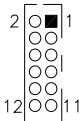

Signal Name	Pin #	Pin #	Signal Name
LINEOUT R	2	1	LINEOUT L
Ground	4	3	JD FRONT
LINEIN R	6	5	LINEIN
Ground	8	7	JD LINEIN
MIC-In	10	9	MIC L
Ground	12	11	JD MIC1

J13: USB0/USB1 Connector

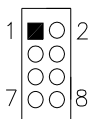

Signal Name	Pin	Pin	Signal Name
Vcc	1	2	Ground
D0-	3	4	D1+
D0+	5	6	D1-
Ground	7	8	Vcc

Note: This USB connector is compatible with USB 2.0 devices only.

This page is intentionally left blank.

BIOS Setup

This chapter describes the different settings available in the Award BIOS that comes with the board. The topics covered in this chapter are as follows:

BIOS Introduction	22
BIOS Setup.....	22
Standard CMOS Setup	24
Advanced BIOS Features	26
Advanced Chipset Features	29
Integrated Peripherals.....	30
Power Management Setup.....	32
PNP/PCI Configurations	34
PC Health Status.....	35
Frequency/Voltage Control	36
Load Fail-Safe Defaults.....	37
Load Optimized Defaults	37
Set Supervisor/User Password.....	37
Save & Exit Setup	37
Exit Without Saving	37

BIOS Introduction

The Award BIOS (Basic Input/Output System) installed in your computer system's ROM supports various processors. The BIOS provides critical low-level support for a standard device such as disk drives, serial ports and parallel ports. It also adds virus and password protection as well as special support for detailed fine-tuning of the chipset controlling the entire system.

BIOS Setup

The Award BIOS provides a Setup utility program for specifying the system configurations and settings. The BIOS ROM of the system stores the Setup utility. When you turn on the computer, the Award BIOS is immediately activated. Pressing the key immediately allows you to enter the Setup utility. If you are a little bit late pressing the key, POST (Power On Self Test) will continue with its test routines, thus preventing you from invoking the Setup. If you still wish to enter Setup, restart the system by pressing the "Reset" button or simultaneously pressing the <Ctrl>, <Alt> and <Delete> keys. You can also restart by turning the system Off and back On again. The following message will appear on the screen:

```
Press <DEL> to Enter Setup
```

In general, you press the arrow keys to highlight items, <Enter> to select, the <PgUp> and <PgDn> keys to change entries, <F1> for help and <Esc> to quit.

When you enter the Setup utility, the Main Menu screen will appear on the screen. The Main Menu allows you to select from various setup functions and exit choices.

Phoenix - AwardBIOS CMOS Setup Utility

Standard CMOS Features	Frequency/Voltage Control
Advanced BIOS Features	Load Fail-Safe Defaults
Advanced Chipset Features	Load Optimized Defaults
Integrated Peripherals	Set Supervisor Password
Power Management Setup	Set User Password
PnP/PCI Configurations	Save & Exit Setup
PC Health Status	Exit Without Saving
ESC : Quit	↑ ↓ → ← : Select Item
F10 : Save & Exit Setup	
Time, Date, Hard Disk Type...	

The section below the setup items of the Main Menu displays the control keys for this menu. At the bottom of the Main Menu just below the control keys section, there is another section, which displays information on the currently highlighted item in the list.

Note: *If the system cannot boot after making and saving system changes with Setup, the Award BIOS supports an override to the CMOS settings that resets your system to its default.*

Warning: *It is strongly recommended that you avoid making any changes to the chipset defaults. These defaults have been carefully chosen by both Award and your system manufacturer to provide the absolute maximum performance and reliability. Changing the defaults could cause the system to become unstable and crash in some cases.*

Standard CMOS Setup

“Standard CMOS Setup” choice allows you to record some basic hardware configurations in your computer system and set the system clock and error handling. If the motherboard is already installed in a working system, you will not need to select this option. You will need to run the Standard CMOS option, however, if you change your system hardware configurations, the onboard battery fails, or the configuration stored in the CMOS memory was lost or damaged.

Phoenix - AwardBIOS CMOS Setup Utility
Standard CMOS Features

		Item Help
Date (mm:dd:yy)	Wed, Apr 28, 2007	Menu Level >
Time (hh:mm:ss)	00 : 00 : 00	
IDE Channel 0 Master	None	Change the day, month, Year and century
IDE Channel 0 Slave	None	
Halt On	No Errors	
Base Memory	640K	
Extended Memory	129024K	
Total Memory	130048K	

At the bottom of the menu are the control keys for use on this menu. If you need any help in each item field, you can press the <F1> key. It will display the relevant information to help you. The memory display at the lower right-hand side of the menu is read-only. It will adjust automatically according to the memory changed. The following describes each item of this menu.

Date

The date format is:

Day : Sun to Sat
Month : 1 to 12
Date : 1 to 31
Year : 1999 to 2099

To set the date, highlight the “Date” field and use the PageUp/PageDown or +/- keys to set the current time.

Time

The time format is: **Hour : 00 to 23**
Minute : 00 to 59
Second : 00 to 59

To set the time, highlight the “Time” field and use the <PgUp>/<PgDn> or +/- keys to set the current time.

IDE Channel Master/Slave

The onboard PCI IDE connector provides Primary and Secondary channels for connecting up to two IDE hard disks or other IDE devices.

Press <Enter> to configure the hard disk. The selections include Auto, Manual, and None. Select ‘Manual’ to define the drive information manually. You will be asked to enter the following items.

CYLS :	Number of cylinders
HEAD :	Number of read/write heads
PRECOMP :	Write precompensation
LANDING ZONE :	Landing zone
SECTOR :	Number of sectors

Remarks: The main board supports two serial ATA ports and are represented in this setting as IDE Channel 0.

Halt On

This field determines whether or not the system will halt if an error is detected during power up.

No errors	The system boot will not be halted for any error that may be detected.
All errors	Whenever the BIOS detects a non-fatal error, the system will stop and you will be prompted.
All, But Keyboard	The system boot will not be halted for a keyboard error; it will stop for all other errors
All, But Diskette	The system boot will not be halted for a disk error; it will stop for all other errors.
All, But Disk/Key	The system boot will not be halted for a keyboard or disk error; it will stop for all others.

Advanced BIOS Features

This section allows you to configure and improve your system and allows you to set up some system features according to your preference.

Phoenix - AwardBIOS CMOS Setup Utility
Advanced BIOS Features

		ITEM HELP
CPU Feature	Press Enter	
Hard Disk Boot Priority	Press Enter	
USB Hard Disk Boot First	Disabled	Menu Level >
Virus Warning	Disabled	
CPU Internal Cache	Enabled	
External Cache	Enabled	
Quick Power On Self Test	Enabled	
First Boot Device	Hard Disk	
Second Boot Device	CDROM	
Third Boot Device	LS120	
Boot Other Device	Enabled	
Boot Up Floppy Seek	Disabled	
Boot Up NumLock Status	On	
Gate A20 Option	Fast	
Typematic Rate Setting	Disabled	
Typematic Rate (Chars/Sec)	6	
Typematic Delay (Msec)	250	
Security Option	Setup	
APIC Mode	Enabled	
MPS Version Control for OS	1.4	
OS Select For DRAM>64MB	Non-OS2	
HDD S.M.A.R.T. Capability	Disabled	

CPU Feature

Press Enter to configure the settings relevant to CPU Feature.

Hard Disk Boot Priority

With the field, there is the option to choose, aside from the hard disks connected, “Bootable add-in Cards” which refers to other external devices.

Virus Warning

If this option is enabled, an alarm message will be displayed when trying to write on the boot sector or on the partition table on the disk, which is typical of the virus.

CPU Internal and External Cache

Cache memory is additional memory that is faster than conventional DRAM (system memory). CPUs from 486-type on up contain internal cache memory, and most, but not all, modern PCs have additional (external) cache memory. When the CPU requests data, the system transfers the requested data from the main DRAM into cache memory, for even faster access by the CPU. These allow you to enable (speed up memory access) or disable the cache function.

Quick Power On Self Test

When enabled, this field speeds up the Power On Self Test (POST) after the system is turned on. If it is set to *Enabled*, BIOS will skip some items.

First/Second/Third Boot Device

These fields determine the drive that the system searches first for an operating system. The options available include *Floppy*, *LS120*, *Hard Disk*, *CDROM*, *ZIP100*, *USB-Floppy*, *USB-ZIP*, *USB-CDROM*, *LAN* and *Disable*.

Boot Other Device

These fields allow the system to search for an OS from other devices other than the ones selected in the First/Second/Third Boot Device.

Boot Up Floppy Seek

This feature controls whether the BIOS checks for a floppy drive while booting up. If it cannot detect one (either due to improper configuration or its absence), it will flash an error message.

Boot Up NumLock Status

This allows you to activate the NumLock function after you power up the system.

Gate A20 Option

This field allows you to select how Gate A20 is worked. Gate A20 is a device used to address memory above 1 MB.

Typematic Rate Setting

When disabled, continually holding down a key on your keyboard will generate only one instance. When enabled, you can set the two typematic controls listed next. By default, this field is set to *Disabled*.

Typematic Rate (Chars/Sec)

When the typematic rate is enabled, the system registers repeated keystrokes speeds. Settings are from 6 to 30 characters per second.

Typematic Delay (Msec)

When the typematic rate is enabled, this item allows you to set the time interval for displaying the first and second characters. By default, this item is set to *250msec*.

Security Option

This field allows you to limit access to the System and Setup. The default value is *Setup*. When you select *System*, the system prompts for the User Password every time you boot up. When you select *Setup*, the system always boots up and prompts for the Supervisor Password only when the Setup utility is called up.

APIC Mode

APIC stands for Advanced Programmable Interrupt Controller. The default setting is *Enabled*.

MPS Version Control for OS

This option specifies the MPS (Multiprocessor Specification) version for your operating system. MPS version 1.4 added extended configuration tables to improve support for multiple PCI bus configurations and improve future expandability. The default setting is *1.4*.

OS Select for DRAM > 64MB

This option allows the system to access greater than 64MB of DRAM memory when used with OS/2 that depends on certain BIOS calls to access memory. The default setting is *Non-OS/2*.

HDD S.M.A.R.T. Capability

By default, this field is disabled.

Advanced Chipset Features

This Setup menu controls the configuration of the chipset.

Phoenix - AwardBIOS CMOS Setup Utility
Advanced Chipset Features

IGX Configuration	Press Enter	ITEM HELP
Memory Hole	Disabled	
System BIOS Cacheable	Disabled	

Phoenix - AwardBIOS CMOS Setup Utility
IGX Configuration

Internal Graphic Mode	UMA	ITEM HELP
UMA Frame Buffer Size	128M	
Current UMA Size	128M	
Video Display Devices	Auto	
LCD Panel Type	Disabled	

Memory Hole At 15M-16M

In order to improve performance, certain space in memory can be reserved for ISA cards. This memory must be mapped into the memory space below 16 MB. The choices are *Enabled* and *Disabled*.

System BIOS Cacheable

The setting of *Enabled* allows caching of the system BIOS ROM at F000h-FFFFh, resulting in better system performance. However, if any program writes to this memory area, a system error may result.

Integrated Peripherals

This section sets configurations for your hard disk and other integrated peripherals. The first screen shows three main items for user to select. Once an item selected, a submenu appears. Details follow.

Phoenix - AwardBIOS CMOS Setup Utility
Integrated Peripherals

South OnChip IDE Device	Press Enter	ITEM HELP
South OnChip PCI Device	Press Enter	Menu Level >
SuperIO Device	Press Enter	
Init Display First	Onboard	
Surroundview	Disabled	
OnChip USB Controller	Enabled	
USB EHCI Controller	Enabled	
OnChip USB KBC Controller	Enabled	
USB Mouse Support	Enabled	
IDE HDD Block Mode	Enabled	

Phoenix - AwardBIOS CMOS Setup Utility
South OnChip IDE Device

IDE DMA transfer access	Enabled	ITEM HELP
On-Chip IDE Channel0	Enabled	Menu Level >
Primary Master PIO	Auto	
Primary Slave PIO	Auto	
Primary Master UDMA	Auto	
Primary Slave UDMA	Auto	

Phoenix - AwardBIOS CMOS Setup Utility
South OnChip PCI Device

HD Azalia Audio	Auto	ITEM HELP
OnChip SATA Controller	Enabled	Menu Level >
OnChip SATA Type	Native IDE	

Phoenix - AwardBIOS CMOS Setup Utility
SuperIO Device

POWER ON Function	BUTTON ONLY	ITEM HELP
KB Power ON Password	Enter	
Hot Key Power ON	Ctrl-F1	
Onboard Serial Port 1	3F8/IRQ4	
Onboard Serial Port 2	2F8/IRQ3	
PWRON After PWR Fail	Off	

Power ON Function

This field is related to how the system is powered on – such as with the use of conventional power button, keyboard or hot keys. The default is **BUTTON ONLY**.

KB Power ON Password

This field allows users to set the password when keyboard power on is the mode of the Power ON function.

Hot Key Power ON

This field sets certain keys, also known as hot keys, on the keyboard that can be used as a ‘switch’ to power on the system.

Onboard Serial Port

These fields allow you to select the onboard serial ports and their addresses. The default values for these ports are:

Serial Port 1	3F8/IRQ4
Serial Port 2	2F8/IRQ3

PWRON After PWR-Fail

This field sets the system power status whether *on* or *off* when power returns to the system from a power failure situation.

Power Management Setup

Phoenix - AwardBIOS CMOS Setup Utility
Power Management Setup

C2 Disable/Enable	Disabled	ITEM HELP Menu Level >
Power Management Option	User Define	
HDD Power Down	Disabled	
Video Off Option	Suspend→Off	
Video Off Method	V/H SYNC+ Blank	
Modem Use IRQ	3	
Soft-Off by PWR-BTTN	Instant-Off	
PowerOn by PCI Card	Disabled	
Modem Ring Resume	Disabled	
ACPI XSDT Table	Disabled	
HPET Support	Enabled	
RTC Alarm Resume	Disabled	
Date (of Month)	0	
Resume Time Alarm (hh:mm:ss)	0 : 0 : 0	

Power Management Option

This field allows you to select the type of power saving management modes. There are four selections for Power Management.

- Min. Power Saving Minimum power management
- Max. Power Saving Maximum power management.
- User Define Each of the ranges is from 1 min. to 1hr. Except for HDD Power Down which ranges from 1 min. to 15 min.

HDD Power Down

When enabled, and after the set time of system inactivity, the hard disk drive will be powered down while all other devices remain active.

Video Off Method

This field defines the Video Off features. There are three options.

- V/H SYNC + Blank Default setting, blank the screen and turn off vertical and horizontal scanning.
- DPMS Allows BIOS to control the video display.
- Blank Screen Writes blanks to the video buffer.

Modem Use IRQ

This field sets the IRQ used by the Modem. By default, the setting is 3.

Soft-Off by PWRBTN

This field defines the power-off mode when using an ATX power supply. The *Instant Off* mode allows powering off immediately upon pressing the power button. In the *Delay 4 Sec* mode, the system powers off when the power button is pressed for more than four seconds or enters the suspend mode when pressed for less than 4 seconds.

PowerOn by PCI Card

By default, this field is disabled.

Modem Ring Resume

This field enables or disables the power on of the system through the modem connected to the serial port or LAN.

HPET Support

HPET, or High Precision Event Timer (formerly known as Multimedia Timer) is a hardware timer that is supported under Linux and Windows Vista. It can produce periodic interrupts at a much higher resolution than the RTC and is often used to synchronize multimedia streams, providing smooth playback and reducing the need to use other timestamp calculations such as an x86 CPU's RDTSC instruction.

PNP/PCI Configurations

This option configures the PCI bus system. All PCI bus systems on the system use INT#, thus all installed PCI cards must be set to this value.

Phoenix - AwardBIOS CMOS Setup Utility
PnP/PCI Configurations

Reset Configuration Data	Disabled	ITEM HELP
Resources Controlled By	Auto (ESCD)	
IRQ Resources	Press Enter	IRQ Resources
PCI/VGA Palette Snoop	Disabled	
Assign IRQ For VGA	Enabled	
Assign IRQ For USB	Enabled	
PCI Latency Timer(CLK)	64	
Maximum Payload Size	4096	

Reset Configuration Data

This field allows you to determine whether to reset the configuration data or not. The default value is **Disabled**.

Resources Controlled by

This PnP BIOS can configure all of the boot and compatible devices with the use of a PnP operating system such as Windows 95.

PCI/VGA Palette Snoop

Some non-standard VGA display cards may not show colors properly. This field allows you to set whether or not MPEG ISA/VESA VGA cards can work with PCI/VGA. When this field is enabled, a PCI/VGA can work with an MPEG ISA/VESA VGA card. When this field is disabled, a PCI/VGA cannot work with an MPEG ISA/VESA card.

Assign IRQ for VGA/USB

The default value is **Enabled**

PCI Latency

PCI latency refers to the number of cycles that any device can hold an IRQ before it is disconnected.

Maximum Payload Size

The default setting of the PCI Express Maximum Payload Size is 4096.

PC Health Status

This section shows the parameters in determining the PC Health Status. These parameters include temperatures, fan speeds and voltages.

Phoenix - AwardBIOS CMOS Setup Utility
PC Health Status

		ITEM HELP
CPU Warning Temperature	Disabled	
System Temp	45°C/113°F	
CPU Temp	45°C/113°F	
North Bridge Temp	30°C/86°F	
FAN1 Speed	5400 RPM	
FAN2 Speed	5400 RPM	
Vcore(V)	1.02 V	
+12V	12.2 V	
Vmem	1.8V	
+5V	5.13 V	
3.3V	3.29V	
VBAT (V)	3.21 V	
3VSB(V)	3.21 V	
System Smart Fan Temp	Disabled	
Fan Tolerance Value	5	
		Menu Level >

CPU Warning Temperature

This field allows the user to set the temperature so that when the temperature is reached, the system sounds a warning. This function can help prevent damage to the system that is caused by overheating.

Temperatures/Voltages

These fields are the parameters of the hardware monitoring function feature of the board. The values are read-only values as monitored by the system and show the PC health status.

1st / 2nd Smart Fan Temperature

This field enables or disables the smart fan feature. At a certain temperature, the fan starts turning. Once the temperature drops to a certain level, it stops turning again.

Frequency/Voltage Control

This section shows the user how to configure the processor frequency.

Phoenix - AwardBIOS CMOS Setup Utility
Frequency/Voltage Control

Spread Spectrum	Disabled	ITEM HELP
CPU Host/SRTC/ATIG	Default	Menu Level >

Spread Spectrum

This field sets the value of the spread spectrum. The default setting is **Disabled**. This field is for CE testing use only.

CPU Host/SRTC/ATIG

This field is set to **Default**.

Load Fail-Safe Defaults

This option allows you to load the troubleshooting default values permanently stored in the BIOS ROM. These default settings are non-optimal and disable all high-performance features.

Load Optimized Defaults

This option allows you to load the default values to your system configuration. These default settings are optimal and enable all high performance features.

Set Supervisor Password

These two options set the system password. Supervisor Password sets a password that will be used to protect the system and Setup utility. User Password sets a password that will be used exclusively on the system. To specify a password, highlight the type you want and press <Enter>. The Enter Password: message prompts on the screen. Type the password, up to eight characters in length, and press <Enter>. The system confirms your password by asking you to type it again. After setting a password, the screen automatically returns to the main screen.

To disable a password, just press the <Enter> key when you are prompted to enter the password. A message will confirm the password to be disabled. Once the password is disabled, the system will boot and you can enter Setup freely.

Save & Exit Setup

This option allows you to determine whether or not to accept the modifications. If you type “Y”, you will quit the setup utility and save all changes into the CMOS memory. If you type “N”, you will return to Setup utility.

Exit Without Saving

Select this option to exit the Setup utility without saving the changes you have made in this session. Typing “Y” will quit the Setup utility without saving the modifications. Typing “N” will return you to Setup utility.

This page is intentionally left blank.

Drivers Installation

This section describes the installation procedures for software and drivers under the Windows 2000 and Windows XP. The software and drivers are included with the motherboard. If you find the items missing, please contact the vendor where you made the purchase. The contents of this section include the following:

SM Bus Controller Driver Installation.....	40
VGA Drivers Installation.....	43
Realtek Codec Audio Driver Installation.....	45
LAN Drivers Installation	46

SM Bus Controller Driver Installation

1. In your Windows operating system, go to the **Device Manager**.
2. Double click **SM Bus Controller** which is under **Other devices** as shown in the picture below to go to the **SM Bus Controller Properties** window.

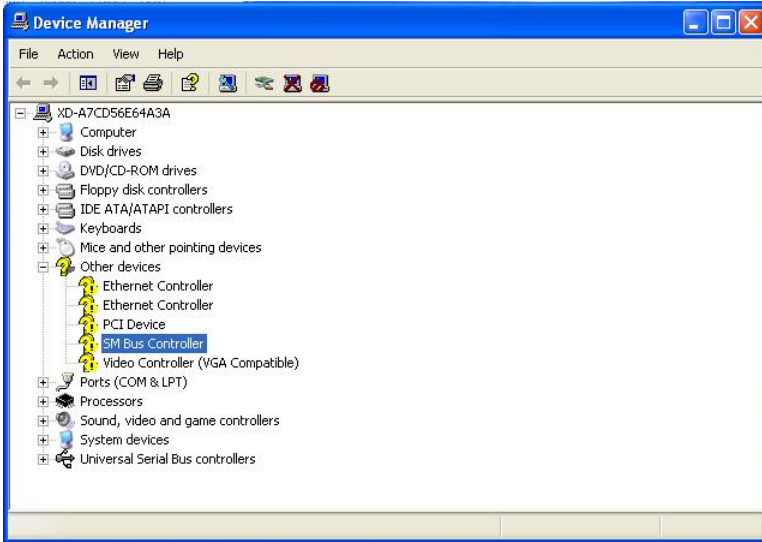

3. Under the **SM Bus Controller Properties** window, click the **Driver** tab and click **Update Driver**.



4. When the welcome screen of the **Hardware Update Wizard** appears, click **No, not this time**, and **Next** to continue.



5. On the next screen, select **Install from a list or specific location (Advanced)**, and click **Next** to continue.

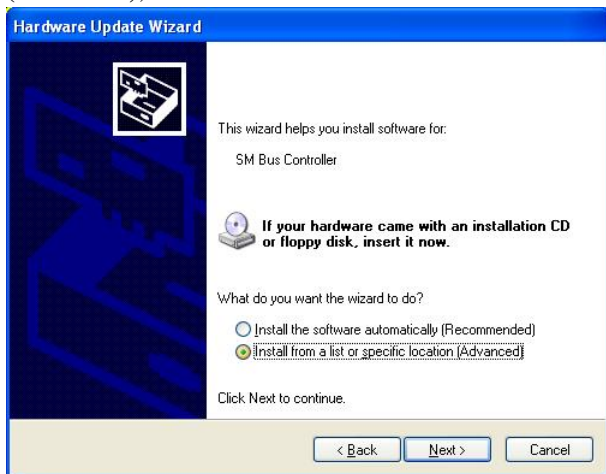

6. Select **Search for the best driver in these locations.**, and enter the path where the drivers are located. If E:\ is your CD ROM drive, enter **E:\Ali\AMD690T\SMBUS** or click **Browse** to search for the path.

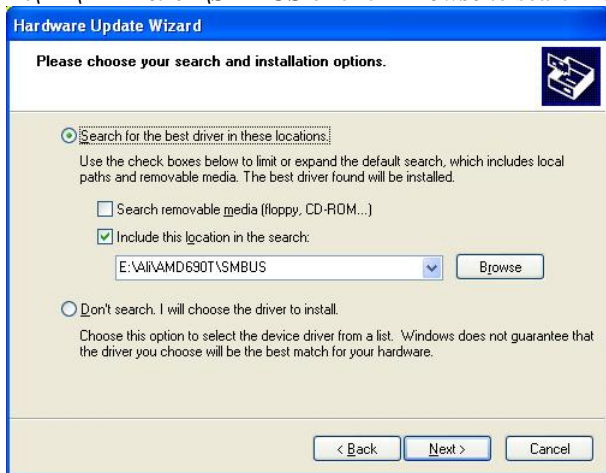

7. When driver installation is complete, click **Finish** for changes to take effect.

VGA Drivers Installation

To install the VGA drivers, follow the steps below to proceed with the installation.

1. Insert the CD that comes with the board. Click **AMD M690T/E Chipset Drivers**.

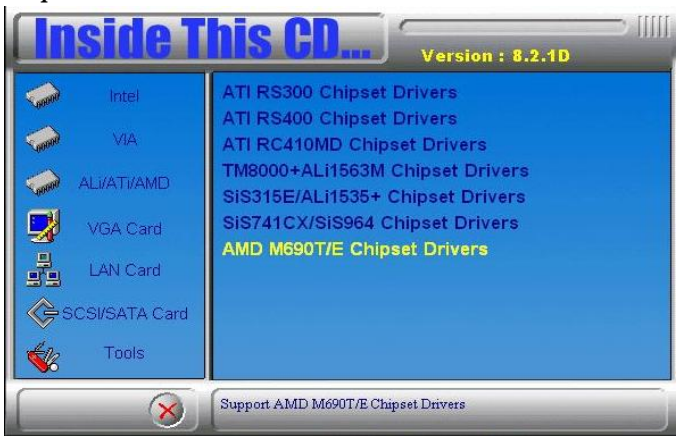

2. Click **ATI Radeon X1200 Serial Graphics Drivers** as shown below.

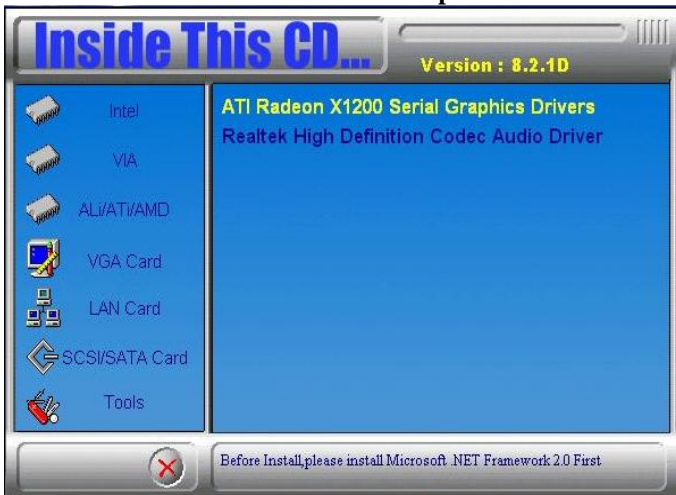

Remarks: Before installing this driver, you have to install Microsoft .NET Framework 2.0. Please go the Microsoft website to do this.

3. In the Welcome screen, click **Next** to continue. Then, in the License Agreement screen, also click **Yes** to continue.

4. When the **Select Components** screen appears, click **Express: Recommended**, in selecting the component that you want to install.

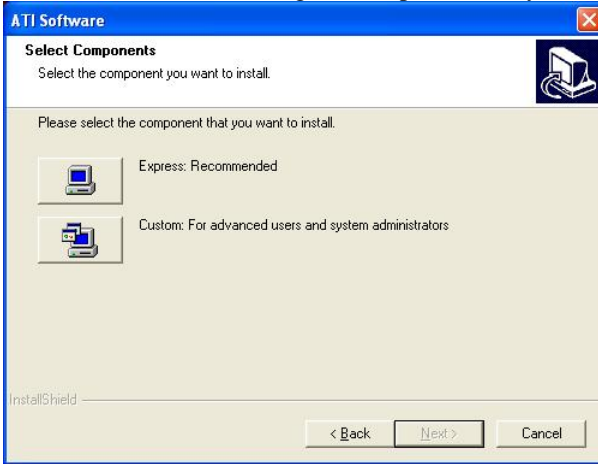

5. When the message regarding Windows Logo testing appears, click **Continue Anyway** to proceed with the driver installation.



6. Setup is now complete. Click **Finish** to restart the computer and for changes to take effect.

Realtek High Definition Codec Audio Driver Installation

Follow the steps below to install the Audio Drivers.

1. Insert the CD that comes with the board. Click **AMD M690T/E Chipset Drivers**.

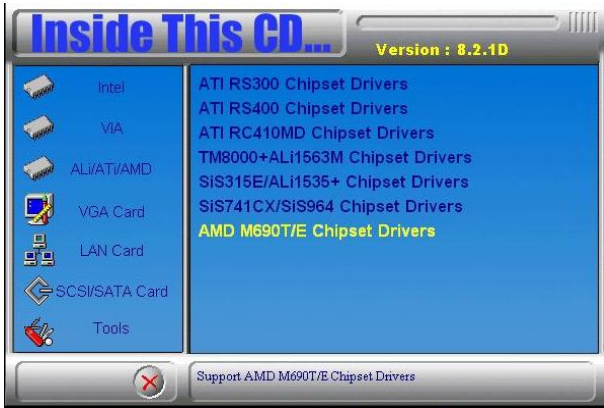

2. Click **Realtek High Definition Codec Audio Driver**.

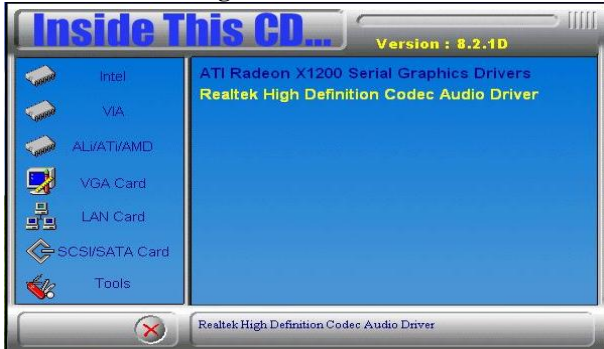

3. In the **Welcome** screen, click **Next** to continue. After the driver installation, click **Finish** on the next screen to restart the computer.

LAN Drivers Installation

1. Insert the CD that comes with the motherboard. Click **LAN Card** on the left side and click **Realtek GbE_FE Ethernet PCI-E NIC Driver**.



2. When the Welcome screen of the **InstallShield Wizard** appears, click **Next** to continue.

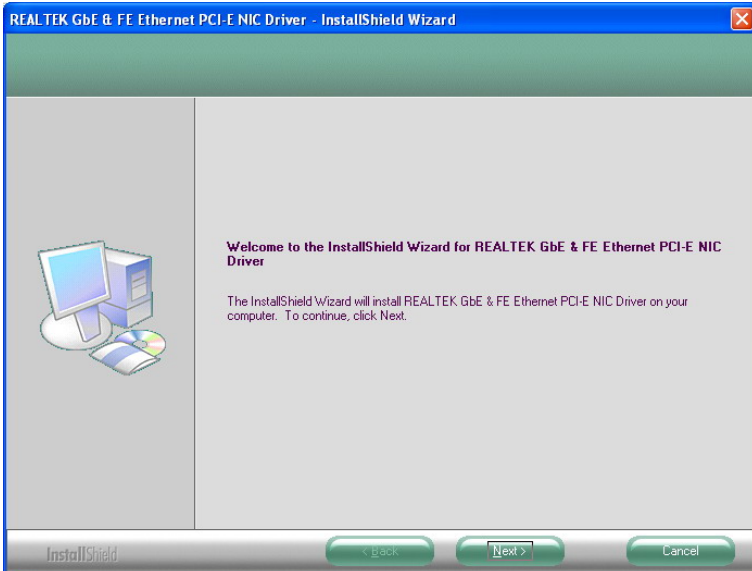

3. On the next screen, you are asked to click **Install** to begin the installation process. Now, click **Install** to proceed.

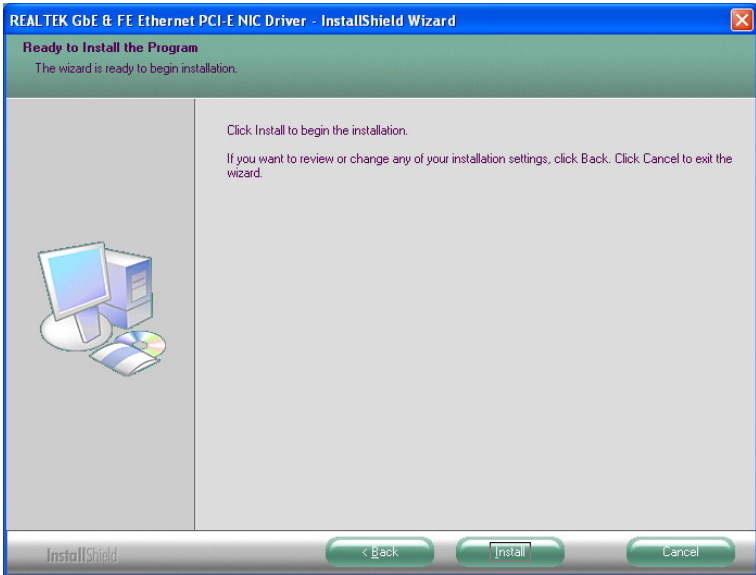

4. Installation is now complete, click **Finish** to exit the InstallShield Wizard.

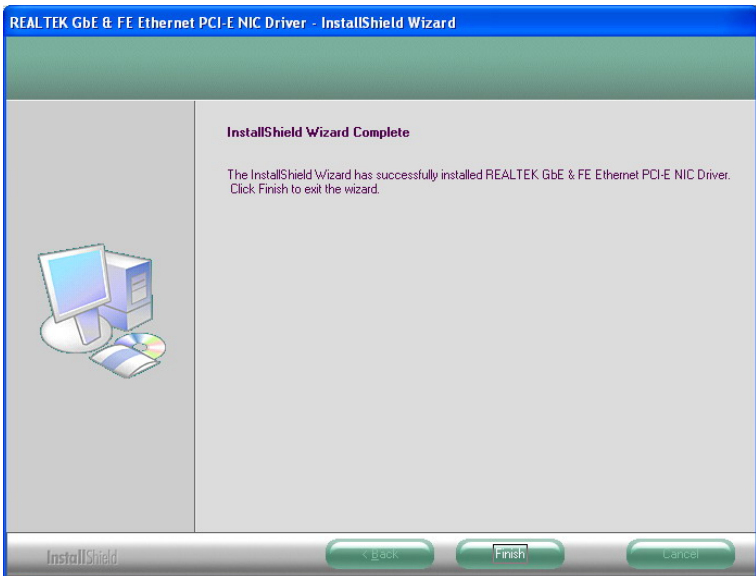

This page is intentionally left blank.

Appendix

A. I/O Port Address Map

Each peripheral device in the system is assigned a set of I/O port addresses which also becomes the identity of the device. The following table lists the I/O port addresses used.

Address	Device Description
000h - 01Fh	DMA Controller #1
020h - 03Fh	Interrupt Controller #1
040h - 05Fh	Timer
060h - 06Fh	Keyboard Controller
070h - 07Fh	Real Time Clock, NMI
080h - 09Fh	DMA Page Register
0A0h - 0BFh	Interrupt Controller #2
0C0h - 0DFh	DMA Controller #2
0F0h	Clear Math Coprocessor Busy Signal
0F1h	Reset Math Coprocessor
1F0h - 1F7h	IDE Interface
278 - 27F	Parallel Port #2(LPT2)
2F8h - 2FFh	Serial Port #2(COM2)
2B0 - 2DF	Graphics adapter Controller
378h - 3FFh	Parallel Port #1(LPT1)
360 - 36F	Network Ports
3B0 - 3BF	Monochrome & Printer adapter
3C0 - 3CF	EGA adapter
3D0 - 3DF	CGA adapter
3F0h - 3F7h	Floppy Disk Controller
3F8h - 3FFh	Serial Port #1(COM1)

B. Interrupt Request Lines (IRQ)

Peripheral devices use interrupt request lines to notify CPU for the service required. The following table shows the IRQ used by the devices on board.

Level	Function
IRQ0	System Timer Output
IRQ1	Keyboard
IRQ2	Interrupt Cascade
IRQ3	Serial Port #2
IRQ4	Serial Port #1
IRQ5	Reserved
IRQ6	Floppy Disk Controller
IRQ7	Parallel Port #1
IRQ8	Real Time Clock
IRQ9	Reserved
IRQ10	Reserved
IRQ11	Reserved
IRQ12	PS/2 Mouse
IRQ13	80287
IRQ14	Primary IDE
IRQ15	Secondary IDE

C. Watchdog Timer Configuration

The WDT is used to generate a variety of output signals after a user programmable count. The WDT is suitable for use in the prevention of system lock-up, such as when software becomes trapped in a deadlock. Under these sorts of circumstances, the timer will count to zero and the selected outputs will be driven. Under normal circumstance, the user will restart the WDT at regular intervals before the timer counts to zero.

SAMPLE CODE:

```

//=====
//
// THIS CODE AND INFORMATION IS PROVIDED "AS IS" WITHOUT WARRANTY OF ANY
// KIND, EITHER EXPRESSED OR IMPLIED, INCLUDING BUT NOT LIMITED TO THE
// IMPLIED WARRANTIES OF MERCHANTABILITY AND/OR FITNESS FOR A PARTICULAR
// PURPOSE.
//
//=====
#include <stdio.h>
#include <stdlib.h>
#include "W627EHF.H"
//=====
int main (int argc, char *argv[]);
void copyright(void);
void EnableWDT(int);
void DisableWDT(void);
//=====
int main (int argc, char *argv[])
{
    unsigned char bBuf;
    unsigned char bTime;
    char **endptr;

    copyright();

    if (argc != 2)
    {
        printf(" Parameter incorrect!!\n");
        return 1;
    }

    if (Init_W627EHF() == 0)
    {
        printf(" Winbond 83627HF is not detected, program abort.\n");
        return 1;
    }
    bTime = strtol (argv[1], endptr, 10);
    printf("System will reset after %d seconds\n", bTime);

    EnableWDT(bTime);

    return 0;
}
//=====

```

```

void copyright(void)
{
    printf("\n===== Winbond 83627EHF Watch Timer Tester (AUTO DETECT) =====\n")
        " Usage : W627E_WD reset_time\n"
        " Ex : W627E_WD 3 => reset system after 3 second\n"
        " W627E_WD 0 => disable watch dog timer\n");
}
//=====
void EnableWDT(int interval)
{
    unsigned char bBuf;

    bBuf = Get_W627EHF_Reg( 0x2D);
    bBuf &= (!0x01);
    Set_W627EHF_Reg( 0x2D, bBuf); //Enable WDTO

    Set_W627EHF_LD( 0x08); //switch to logic device 8
    Set_W627EHF_Reg( 0x30, 0x01); //enable timer

    bBuf = Get_W627EHF_Reg( 0xF5);
    bBuf &= (!0x08);
    Set_W627EHF_Reg( 0xF5, bBuf); //count mode is second

    Set_W627EHF_Reg( 0xF6, interval); //set timer
}
//=====
void DisableWDT(void)
{
    Set_W627EHF_LD(0x08); //switch to logic device 8
    Set_W627EHF_Reg(0xF6, 0x00); //clear watchdog timer
    Set_W627EHF_Reg(0x30, 0x00); //watchdog disabled
}
//=====

```

```

//=====
//
// THIS CODE AND INFORMATION IS PROVIDED "AS IS" WITHOUT WARRANTY OF ANY
// KIND, EITHER EXPRESSED OR IMPLIED, INCLUDING BUT NOT LIMITED TO THE
// IMPLIED WARRANTIES OF MERCHANTABILITY AND/OR FITNESS FOR A PARTICULAR
// PURPOSE.
//
//=====
#include "W627EHF.H"
#include <dos.h>
//=====
unsigned int W627EHF_BASE;
void Unlock_W627EHF (void);
void Lock_W627EHF (void);
//=====
unsigned int Init_W627EHF(void)
{
    unsigned int result;
    unsigned char ucDid;

    W627EHF_BASE = 0x2E;
    result = W627EHF_BASE;

    ucDid = Get_W627EHF_Reg(0x20);
    if (ucDid == 0x88)
    {
        goto Init_Finish;
    }

    W627EHF_BASE = 0x4E;
    result = W627EHF_BASE;
    ucDid = Get_W627EHF_Reg(0x20);
    if (ucDid == 0x88)
    {
        goto Init_Finish;
    }

    W627EHF_BASE = 0x00;
    result = W627EHF_BASE;

Init_Finish:
    return (result);
}
//=====
void Unlock_W627EHF (void)
{
    outportb(W627EHF_INDEX_PORT, W627EHF_UNLOCK);
    outportb(W627EHF_INDEX_PORT, W627EHF_UNLOCK);
}
//=====
void Lock_W627EHF (void)
{
    outportb(W627EHF_INDEX_PORT, W627EHF_LOCK);
}
//=====
void Set_W627EHF_LD( unsigned char LD)
{
    Unlock_W627EHF();
    outportb(W627EHF_INDEX_PORT, W627EHF_REG_LD);
    outportb(W627EHF_DATA_PORT, LD);
    Lock_W627EHF();
}

```

APPENDIX

```
=====
void Set_W627EHF_Reg( unsigned char REG, unsigned char DATA)
{
    Unlock_W627EHF();
    outportb(W627EHF_INDEX_PORT, REG);
    outportb(W627EHF_DATA_PORT, DATA);
    Lock_W627EHF();
}
=====
unsigned char Get_W627EHF_Reg(unsigned char REG)
{
    unsigned char Result;
    Unlock_W627EHF();
    outportb(W627EHF_INDEX_PORT, REG);
    Result = inportb(W627EHF_DATA_PORT);
    Lock_W627EHF();
    return Result;
}
=====

=====
//
// THIS CODE AND INFORMATION IS PROVIDED "AS IS" WITHOUT WARRANTY OF ANY
// KIND, EITHER EXPRESSED OR IMPLIED, INCLUDING BUT NOT LIMITED TO THE
// IMPLIED WARRANTIES OF MERCHANTABILITY AND/OR FITNESS FOR A PARTICULAR
// PURPOSE.
//
=====
#ifndef __W627EHF_H
#define __W627EHF_H                1
=====
#define W627EHF_INDEX_PORT      (W627EHF_BASE)
#define W627EHF_DATA_PORT      (W627EHF_BASE+1)
=====
#define W627EHF_REG_LD          0x07
=====
#define W627EHF_UNLOCK          0x87
#define W627EHF_LOCK            0xAA
=====
unsigned int Init_W627EHF(void);
void Set_W627EHF_LD( unsigned char);
void Set_W627EHF_Reg( unsigned char, unsigned char);
unsigned char Get_W627EHF_Reg( unsigned char);
=====
#endif //__W627EHF_H
```