

MI945

**Intel® Core™ 2 Duo/GM45
Mini-ITX Motherboard**

USER'S MANUAL

Version 1.0A

Acknowledgments

Award is a registered trademark of Award Software International, Inc.

PS/2 is a trademark of International Business Machines Corporation.

Intel and Intel® Core 2 Duo and Intel® Celeron processors are registered trademarks of Intel Corporation.

Microsoft Windows is a registered trademark of Microsoft Corporation.

Winbond is a registered trademark of Winbond Electronics Corporation.

All other product names or trademarks are properties of their respective owners.

Table of Contents

Introduction	1
Product Description.....	1
Checklist.....	2
MI945 Specifications	3
Board Dimensions	4
Installations	5
Installing the CPU	6
Installing the Memory	7
Setting the Jumpers	8
Connectors on MI945.....	12
BIOS Setup.....	25
Drivers Installation	47
Intel Chipset Software Installation Utility	48
VGA Drivers Installation	50
AC97 Codec Audio Driver Installation.....	52
LAN Drivers Installation.....	53
Appendix.....	55
A. I/O Port Address Map	55
B. Interrupt Request Lines (IRQ).....	56
C. Watchdog Timer Configuration	57

IMPORTANT NOTE: *When the system boots without the CRT being connected, there will be no image on screen when you insert the CRT/VGA cable. To show the image on screen, the hotkey must be pressed (CTRL-ALT-F1).*

Remarks: *The IDE connector on board does not support OS installation in hard drive. A system hard drive connected to this IDE cannot be booted up to OS.*

Introduction

Product Description

The MI945 Mini ITX board incorporates the Mobile Intel® GM45 Express Chipset for Embedded Computing, consisting of the Intel® GM45 Graphic Memory Controller Hub (GMCH) and Intel® I/O Controller Hub (ICH9-M), an optimized integrated graphics solution with a 1066MHz and 800MHz front-side bus. Dimensions of the board are 170mm x 170mm.

The integrated powerful 3D graphics engine, based on Intel® Graphics Media Accelerator X3500 (Intel® GMA X3500) architecture, operates at core speeds of up to 533 MHz. It features a low-power design, is validated with the Intel® Core 2 Duo processors on 45nm process. With dual channel DDR2 800MHz two SoDIMM sockets on board, the board supports up to 4GB of DDR2 system memory.

Intel® Graphics supports a unique intelligent memory management scheme called Dynamic Video Memory Technology (DVMT). DVMT handles diverse applications by providing the maximum (384MB) availability of system memory for general computer usage, while supplying additional graphics memory when a 3D-intensive application requests it. The Intel GMA X3500 graphics architecture also takes advantage of the high-performance Intel processor. Intel GMA X3500 graphics supports Dual Independent Display technology.

The main features of the board are:

- Supports Intel® Core™ 2 Duo (Penryn 1066MHz)
- Supports up to 2.53GHz, 1066MHz/800MHz FSB
- Two DDR2 SoDIMM, Max. 4GB memory
- Onboard Gigabit PHY and Intel PCI-Express Gigabit LAN
- Intel® GM45 Express VGA for CRT / LVDS
- 4x SATA, 8x USB 2.0, 4x COM, Watchdog timer
- 1x Mini PCI-E (Mini Card), 1x PCI, 1xPCI-E(x1) slots

Optional daughter cards:

ID390: Chronitel 7308, supports 24 bit single or dual LVDS channel

ID390C: Chronitel 7021, supports CRT

ID391: Chronitel 7307C, single DVI (connector on cable)

ID391D: Chronitel 7307C, dual DVI (connector on cable)

ID392D: Chronitel 7307C, dual DVI (one connector on card and one on cable)

Checklist

Your MI945 package should include the items listed below.

- The MI945 Mini-ITX motherboard
- This User's Manual
- 1 CD containing chipset drivers and flash memory utility
- Cable kit (IDE, Serial port, Serial ATA)

MI945 Specifications

CPU Supported	Intel® Core™ 2 Duo (Penryn), mobile processors
CPU Voltage	0.700V ~ 1.5V (IMVP-6)
System Speed	Up to 2.53GHz or above
CPU FSB	667MHz/800MHz/1066MHz FSB
Cache	1MB/2MB/4MB
Green /APM	APM1.2
CPU Socket	mPGA Socket 478
Chipset	Intel GM45 Chipset GMCH: GM45 1329-pin Micro-FCBGA ICH9M: 82801IBM 678-pin mBGA
BIOS	Award BIOS, supports ACPI function
Memory	DDR2 667/800 SoDIMM x2 (w/o ECC function), Max. 4GB
VGA	GM45 built-in, supports CRT
SDVO (Dual CH)	Through ID390 card (Chrontel 7308, 24+24 bits single/dual channel LVDS, Chrontel 7021, CRT) Through ID391 card (Chrontel 7307C, DVI single or Dual)
LVDS LCD Panel	GM45 built-in, supports 24-bit, single or dual channel LVDS
LAN	1. ICH9M 10/100/gigabit MAC + PHY <ul style="list-style-type: none"> • Intel 82567L 10/100/1000 2. Intell 82574L PCI-e Gigabit LAN controller x1 (MI945F)
USB	ICH9M built-in USB 2.0 host controller, support 8 ports
Serial ATA Ports	ICH9M built-in SATA controller, supports 4 ports
Parallel IDE	JMicron JM368 (PCI-e to PATA) x1 for 1 PATA channel for IDE & CF
Audio	ICH9M built-in audio controller + AC97 Codec ALC888 w/ 7.1 channels, SPDIF-OUT
LPC I/O	W83627DHG: COM1, COM2 (RS232/RS422/RS485), hardware monitor (3 thermal, 4 voltage monitor inputs, 2 fan headers) - Fintek 81216G for COM3 and COM4
Digital IO	4 in & 4 out
Keyboard/Mouse	Supports PS/2 keyboard/mouse connector
Expansion Slots	PCI slot x1, PIC-E (x1) slot x1 and Mini PCIE socket x1
Edge Connector	PS/2 connector x1 for keyboard/mouse Gigabit LAN RJ-45 + dual USB stack connector Gigabit LAN RJ45 Dual USB stack connector DB9 x1 for COM 1; DB15 x1 for VGA RCA Jack 3x2 for Audio (Front-Out, Line-In, Mic, Center/LFE, Surround & Surround Back)
Onboard Header/ Connector	40 pins box-header x1 for IDE1 CF connector x1 @ solder side 10-pin header x1 for Digital I/O; 10-pin header x1 for COM2 10-pin header x 2 for USB 5,6,7,8 DF13 connector x2 for LVDS; 10-pin header x1 for audio Line-Out & Mic 4-pin header x1 for CD in, SPDIF-out connector x1 SATA connector x4 for SATA ports
Watchdog Timer	Yes (256 segments, 0, 1, 2...255 sec/min)
System Voltage	+5V, +3.3V, +12V, -12V, 5VSB (2A)
Others	Modem Wakeup, LAN Wakeup
Board Size	170mm x 170mm (Mini ITX)

Board Dimensions

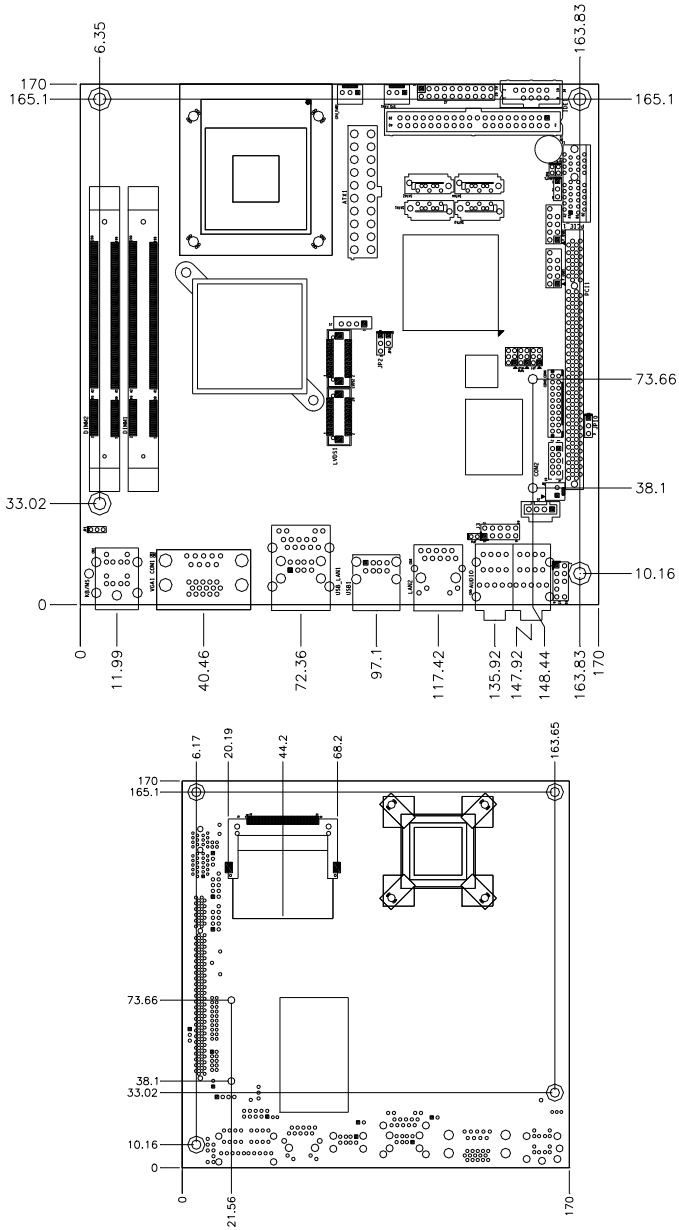

Installations

This section provides information on how to use the jumpers and connectors on the MI945 in order to set up a workable system. The topics covered are:

Installing the CPU.....	6
Installing the Memory.....	7
Setting the Jumpers.....	8
Connectors on MI945	12

Installing the CPU

The MI910 board supports a Socket 478MN (Merom) processor socket for Intel® Core™ 2 Duo, Intel® Celeron mobile processors.

The processor socket comes with a screw to secure the processor. As shown in the left picture below, loosen the screw first before inserting the processor. Place the processor into the socket by making sure the notch on the corner of the CPU corresponds with the notch on the inside of the socket. Once the processor has slide into the socket, fasten the screw. Refer to the figures below.

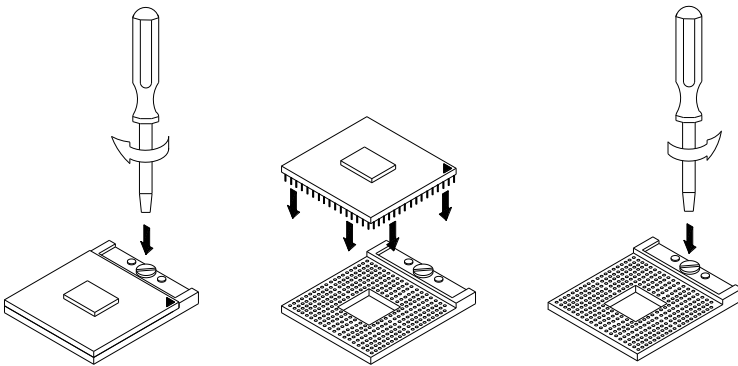

NOTE: Ensure that the CPU heat sink and the CPU top surface are in total contact to avoid CPU overheating problem that would cause your system to hang or be unstable.

Installing the Memory

The MI945 board supports two DDR2 memory socket for a maximum total memory of 4GB in DDR2 memory type.

Installing and Removing Memory Modules

To install the DDR2 modules, locate the memory slot on the board and perform the following steps:

1. Hold the DDR2 module so that the key of the DDR2 module aligned with that on the memory slot.
2. Gently push the DDR2 module in an upright position until the clips of the slot close to hold the DDR2 module in place when the DDR2 module touches the bottom of the slot.
3. To remove the DDR2 module, press the clips with both hands.

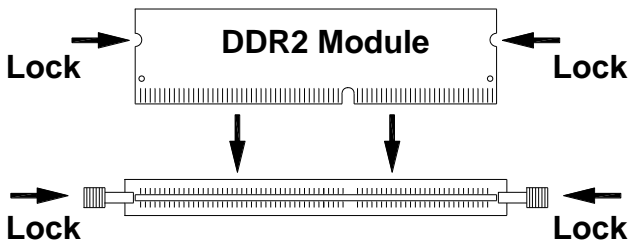

Setting the Jumpers

Jumpers are used on MI945 to select various settings and features according to your needs and applications. Contact your supplier if you have doubts about the best configuration for your needs. The following lists the connectors on MI945 and their respective functions.

Jumper Locations on MI945	9
JP1: Keyboard/Mouse Power Selection	10
JP2: LCD Panel Power Selection	10
JP5, JP6, JP7: RS232/422/485 (COM2) Selection	10
JP9: CompactFlash Slave/Master Selection	11
JP10: PCI/PCIE Riser Card Selection.....	11
JBAT1: Clear CMOS Setting.....	11

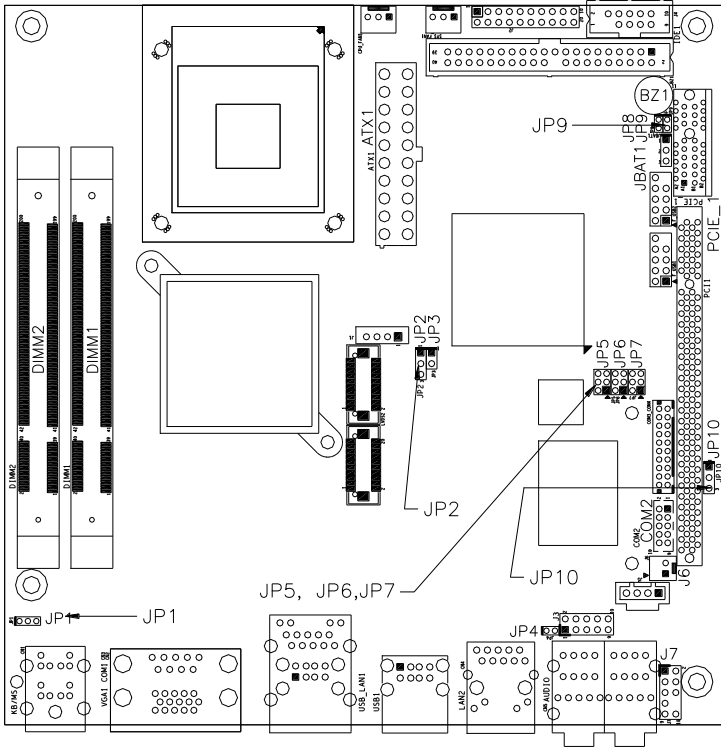

IMPORTANT NOTE: When the system boots without the CRT being connected, there will be no image on screen when you insert the CRT/VGA cable. To show the image on screen, the hotkey must be pressed.

Jumper Locations on MI945





Jumpers on MI945	Page
JP1: Keyboard/Mouse Power Selection	10
JP2: LCD Panel Power Selection	10
JP5, JP6, JP7: RS232/422/485 (COM2) Selection	10
JP9: CompactFlash Slave/Master Selection	11
JP10: PCI/PCIE Riser Card Selection	11
JBAT1: Clear CMOS Setting	11

JP1: Keyboard/Mouse Power Selection

JP1	KB/MS Power
	5V
	5VSB(Standby)

JP2: LCD Panel Power Selection

JP2	LCD Panel Power
	3.3V
	5V

JP5, JP6, JP7: RS232/422/485 (COM2) Selection

COM1 is fixed for RS-232 use only.

COM2 is selectable for RS232, RS-422 and RS-485.

The following table describes the jumper settings for COM2 selection.

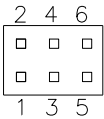



COM2 Function	RS-232	RS-422	RS-485
Jumper Setting (pin closed)	JP5: 1-2	JP5: 3-4	JP5: 5-6
	JP6: 3-5 & 4-6	JP6: 1-3 & 2-4	JP6: 1-3 & 2-4
	JP7: 3-5 & 4-6	JP7: 1-3 & 2-4	JP7: 1-3 & 2-4



COM2 is jumper selectable for RS-232, RS-422 and RS-485.

Pin #	Signal Name		
	RS-232	R2-422	RS-485
1	DCD	TX-	DATA-
2	RX	TX+	DATA+
3	TX	RX+	NC
4	DTR	RX-	NC
5	Ground	Ground	Ground
6	DSR	RTS-	NC
7	RTS	RTS+	NC
8	CTS	CTS+	NC
9	RI	CTS-	NC
10	NC	NC	NC



JP9: CompactFlash Slave/Master Selection

JP9	CF Setting
 Short	Master
 Open	Slave

JP10: PCI/PCIE Riser Card Selection

JP10	Riser Card
 1 2 3	IP390 Riser Card Install
 1 2 3	IP151, IP240 Riser Card Install

JBAT1: Clear CMOS Setting

JBAT1	Setting
 1 2 3	Normal
 1 2 3	Clear CMOS

Connectors on MI945

Connector Locations on MI945	13
CN1: PS/2 Keyboard and PS/2 Mouse Connectors.....	14
CN2, CN3: COM1 and VGA Connector	14
USB_LAN1: 10/100/1000 RJ-45(MI945) and USB1/2 Ports	15
CN4: GbE RJ-45(MI945F)	15
USB1: USB3/4 Ports	15
J6: SPDIF Out Connector	15
CN5: Audio Connector	15
SYS_FAN1: System Fan Power Connector	15
CPU_FAN1: CPU Fan Power Connector	15
IDE1: IDE Connector	16
COM3_COM4: COM3, COM4 Serial Port	16
ATX1: ATX Power Supply Connector	17
J2 (F_PANEL): System Function Connector	17
F_USB1: USB5/USB6 Connector	19
COM2: COM2 Serial Port	19
LVDS1, LVDS2: LVDS Connectors (1st channel, 2nd channel).....	19
J1: LCD Backlight Connector	20
JMINI: Mini PCIE Connector.....	20
SATA1, SATA2, SATA3, SATA4: SATA Connectors.....	20
J3: Digital I/O	20
J5: CD-In Pin Header.....	20
J4: SPI Flash Connector (factory use only).....	20
J7: Front Audio Connector.....	20
J8: PCI-E(x1) Slot.....	20
F_USB2: USB7/USB8 Connector	21
J9: Compact Flash Connector	21
PCI1: PCI Slot (supports 2 Master)	21
CON1: SDVO Port Connector.....	21
Headers and Connectors on MI910 Daughter Cards	22
ID390 – JP4 LCD Panel Power Selection	22
ID390 – J1 LCD Backlight Setting.....	22
ID390 – J3 and J2 1 st /2 nd LVDS Channel Connectors.....	22
ID390C – J4 VGA Connector.....	23
ID391 – J2 DVI Connector.....	24
ID391D – J1, J2 1 st /2 nd DVI Connectors	24

Connector Locations on MI945

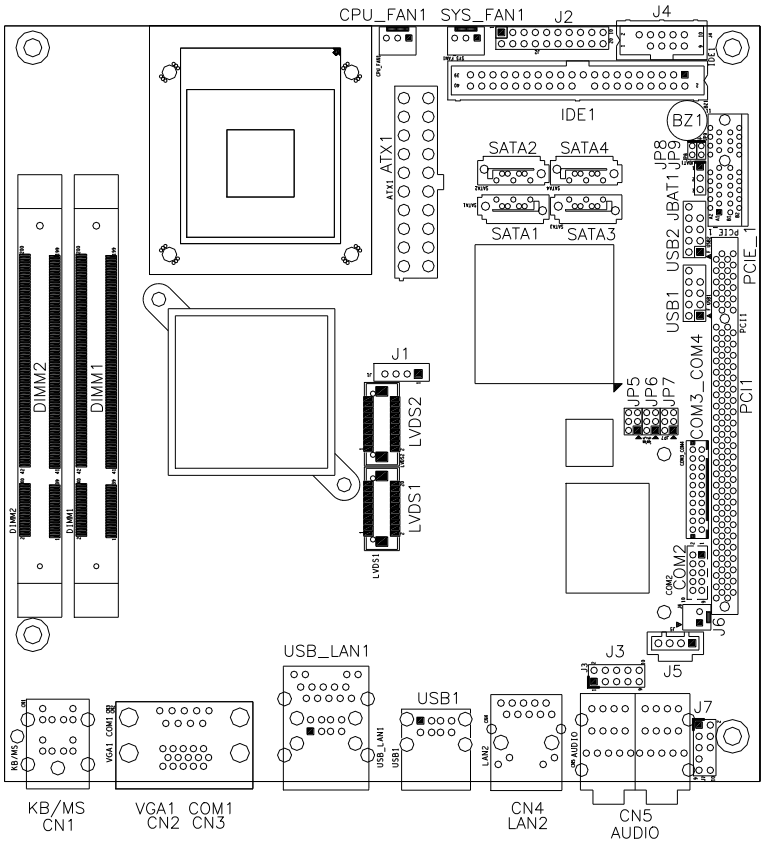

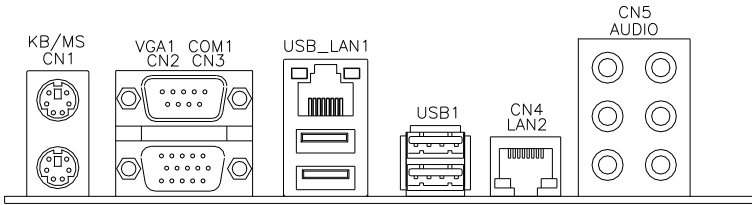

CN1: PS/2 Keyboard and PS/2 Mouse Connectors

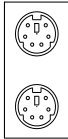

PS/2 Mouse

PS/2 Keyboard

Signal Name	Keyboard	Mouse	Signal Name
Keyboard data	1	1	Mouse data
N.C.	2	2	N.C.
GND	3	3	GND
5V	4	4	5V
Keyboard clock	5	5	Mouse clock
N.C.	6	6	N.C.

CN2, CN3: COM1 and VGA Connector

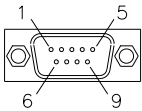

Signal Name	Pin #	Pin #	Signal Name
DCD	1	6	DSR
RXD	2	7	RTS
TXD	3	8	CTS
DTR	4	9	RI
GND	5	10	Not Used

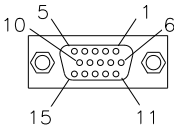

Signal Name	Pin #	Pin #	Signal Name
Red	1	2	Green
Blue	3	4	N.C.
GND	5	6	GND
GND	7	8	GND
N.C.	9	10	GND
N.C.	11	12	N.C.
HSYNC	13	14	VSYNC
NC	15		

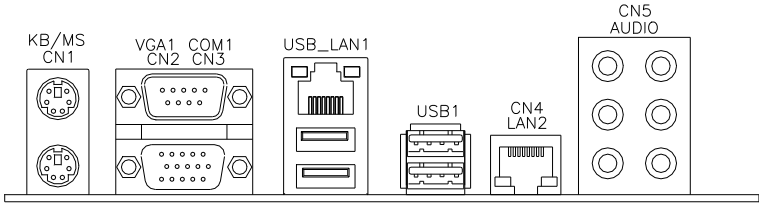

USB_LAN1: 10/100/1000 RJ-45 (MI945) and USB1/2 Ports

CN4: GbE RJ-45 (MI945F)

USB1: USB3/4 Ports

J6: SPDIF Out Connector

CN5: Audio Connector

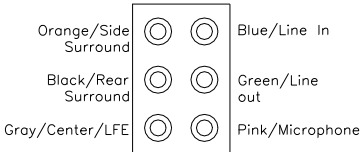

SYS_FAN1: System Fan Power Connector

This is a 3-pin header for system fans. The fan must be a 12V (500mA).



Pin #	Signal Name
1	Ground
2	+12V
3	Rotation detection

CPU_FAN1: CPU Fan Power Connector

This is a 3-pin header for the CPU fan. The fan must be a 12V fan.



Pin #	Signal Name
1	Ground
2	+12V
3	Rotation detection

INSTALLATIONS

IDE1: IDE Connector

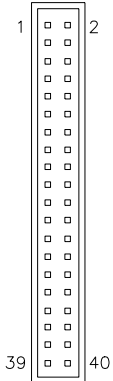

Signal Name	Pin #	Pin #	Signal Name
Reset IDE	1	2	Ground
Host data 7	3	4	Host data 8
Host data 6	5	6	Host data 9
Host data 5	7	8	Host data 10
Host data 4	9	10	Host data 11
Host data 3	11	12	Host data 12
Host data 2	13	14	Host data 13
Host data 1	15	16	Host data 14
Host data 0	17	18	Host data 15
Ground	19	20	Protect pin
DRQ0	21	22	Ground
Host IOW	23	24	Ground
Host IOR	25	26	Ground
IOCHRDY	27	28	Host ALE
DACK0	29	30	Ground
IRQ14	31	32	No connect
Address 1	33	34	No connect
Address 0	35	36	Address 2
Chip select 0	37	38	Chip select 1
Activity	39	40	Ground

COM3_COM4: COM3, COM4 Serial Port

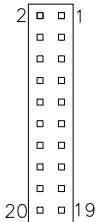

Signal Name	Pin #	Pin #	Signal Name
DSR	2	1	DCD
RTS	4	3	RXD
CTS	6	5	TXD
RI	8	7	DTR
NA	10	9	Ground
DSR	12	11	DCD
RTS	14	13	RXD
CTS	16	15	TXD
RI	18	17	DTR
NA	20	19	Ground

ATX1: ATX Power Supply Connector

Signal Name	Pin #	Pin #	Signal Name
3.3V	11	1	3.3V
-12V	12	2	3.3V
Ground	13	3	Ground
PS-ON	14	4	+5V
Ground	15	5	Ground
Ground	16	6	+5V
Ground	17	7	Ground
-5V	18	8	Power good
+5V	19	9	5VSB
+5V	20	10	+12V

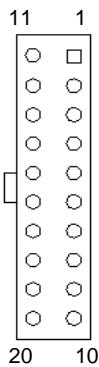

J2 (F_PANEL): System Function Connector

J2 provides connectors for system indicators that provide light indication of the computer activities and switches to change the computer status. J2 is a 20-pin header that provides interfaces for the following functions.

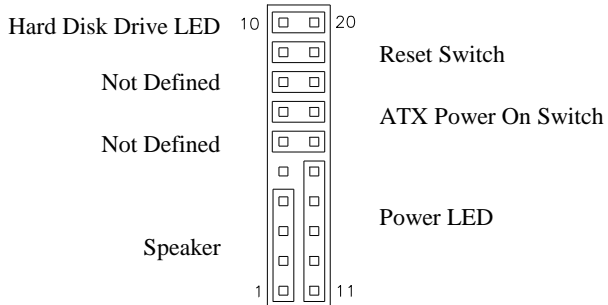

Speaker: Pins 1 - 4

This connector provides an interface to a speaker for audio tone generation. An 8-ohm speaker is recommended.

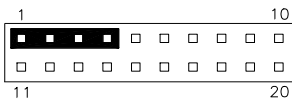

Pin #	Signal Name
1	Speaker out
2	No connect
3	Ground
4	+5V

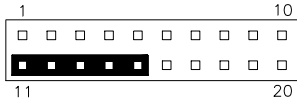
Power LED: Pins 11 - 15

Pin #	Signal Name
11	Power LED
12	No connect
13	Ground
14	No connect
15	Ground

ATX Power ON Switch: Pins 7 and 17

This 2-pin connector is an “ATX Power Supply On/Off Switch” on the system that connects to the power switch on the case. When pressed, the power switch will force the system to power on. When pressed again, it will force the system to power off.

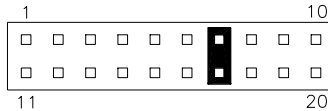
**Reset Switch: Pins 9 and 19**

The reset switch allows the user to reset the system without turning the main power switch off and then on again. Orientation is not required when making a connection to this header.

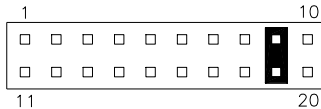
**Hard Disk Drive LED Connector: Pins 10 and 20**

This connector connects to the hard drive activity LED on control panel. This LED will flash when the HDD is being accessed.

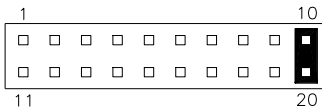

Pin #	Signal Name
10	HDD Active
20	5V

F_USB1: USB5/USB6 Connector

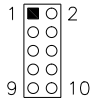

Signal Name	Pin	Pin	Signal Name
Vcc	1	2	Vcc
D0-	3	4	D1-
D0+	5	6	D1+
Ground	7	8	Ground
NC	9	10	Ground

COM2: COM2 Serial Port

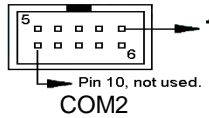

Signal Name	Pin #	Pin #	Signal Name
DCD, Data carrier detect	1	6	DSR, Data set ready
RXD, Receive data	2	7	RTS, Request to send
TXD, Transmit data	3	8	CTS, Clear to send
DTR, Data terminal ready	4	9	RI, Ring indicator
GND, ground	5	10	Not Used

LVDS1, LVDS2: LVDS Connectors (1st channel, 2nd channel)

The LVDS connectors on board consist of the first channel (LVDS1) and second channel (LVDS2).

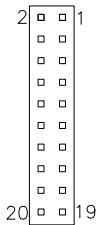

Signal Name	Pin #	Pin #	Signal Name
TX0-	2	1	TX0+
Ground	4	3	Ground
TX1-	6	5	TX1+
5V/3.3V	8	7	Ground
TX3-	10	9	TX3+
TX2-	12	11	TX2+
Ground	14	13	Ground
TXC-	16	15	TXC+
5V/3.3V	18	17	ENABKL
+12V	20	19	+12V

INSTALLATIONS

J1: LCD Backlight Connector



Pin #	Signal Name
1	+12V
2	Backlight Enable
3	Brightness Control
4	Ground

JMINI: Mini PCIE Connector

SATA1, SATA2, SATA3, SATA4: SATA Connectors

J3: Digital I/O

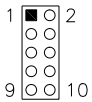

Signal Name	Pin	Pin	Signal Name
GND	1	2	VCC
OUT3	3	4	OUT1
OUT2	5	6	OUT0
IN3	7	8	IN1
IN2	9	10	IN0

J5: CD-In Pin Header



Pin #	Signal Name
1	CD Audio R
2	Ground
3	Ground
4	CD Audio L

J4: SPI Flash Connector (factory use only)

J7: Front Audio Connector

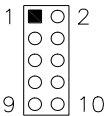

Signal Name	Pin #	Pin #	Signal Name
MIC2_L	1	2	Ground
MIC2_R	3	4	Presence#
Line2_L	5	6	MIC2_ID
Sense	7	8	NC
Line2_R	9	10	Line2_ID

J8: PCI-E(x1) Slot

F_USB2: USB7/USB8 Connector

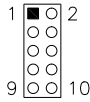

Signal Name	Pin	Pin	Signal Name
Vcc	1	2	Vcc
D0-	3	4	D1-
D0+	5	6	D1+
Ground	7	8	Ground
NC	9	10	Ground

J9: Compact Flash Connector

PCI1: PCI Slot (supports 2 Master)



CON1: SDVO Port Connector

Signal Name	Pin #	Pin #	Signal Name
+12V	A1	B1	+12V
+12V	A2	B2	+12V
+5V	A3	B3	+5V
3.3V	A4	B4	3.3V
RESET	A5	B5	GND
GND	A6	B6	GND
SDVOC_CLK+	A7	B7	SDVOC_CLK-
SDVOC_Blue+	A8	B8	SDVOC_Blue-
GND	A9	B9	GND
SDVOC_Green+	A10	B10	SDVOC_Green-
SDVOC_Red+	A11	B11	SDVOC_Red-
GND	A12	B12	GND
SDVO TVClkIn+	A13	B13	SDVO TVClkIn-
SDVOB Int+	A14	B14	SDVOB Int-
GND	A15	B15	GND
SDVO CtrlData	A16	B16	SDVO CtrlClk
SDVOB Clk+	A17	B17	SDVOB Clk-
GND	A18	B18	GND
SDVOB Blue+	A19	B19	SDVOB Blue-
SDVOB Green+	A20	B20	SDVOB Green-
GND	A21	B21	GND
SDVOB Red+	A22	B22	SDVOB Red-
SDVO Stall+	A23	B23	SDVO Stall-
GND	A24	B24	GND

INSTALLATIONS

Headers and Connectors on MI910 Daughter Cards

ID390 – JP4 LCD Panel Power Selection

JP4	Voltage
 1 2 3	3.3V
 1 2 3	5V

ID390 – J1 LCD Backlight Setting



Pin #	Signal Name
1	+12V
2	Backlight Enable
3	Ground

ID390 – J3 and J2 1st/2nd LVDS Channel Connectors

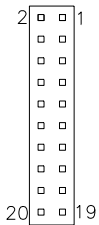

Signal Name	Pin #	Pin #	Signal Name
TX0-	2	1	TX0+
Ground	4	3	Ground
TX1-	6	5	TX1+
5V/3.3V	8	7	Ground
TX3-	10	9	TX3+
TX2-	12	11	TX2+
Ground	14	13	Ground
TXC-	16	15	TXC+
5V/3.3V	18	17	ENABKL
+12V	20	19	+12V

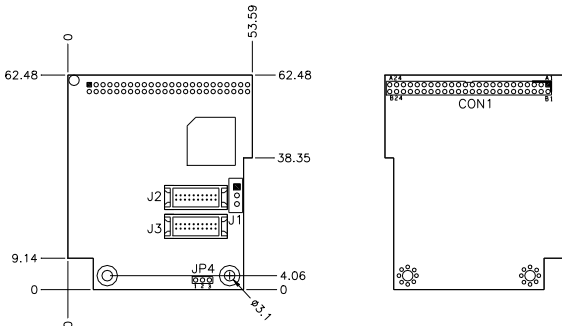

ID390C – J4 VGA Connector

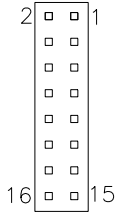

Signal Name	Pin #	Pin #	Signal Name
+5V	2	1	RED
Ground	4	3	GREEN
N.C.	6	5	BLUE
SDA	8	7	N.C.
HSYNC	10	9	Ground
VSYNC	12	11	Ground
SCL	14	13	Ground
N.C.	16	15	Ground

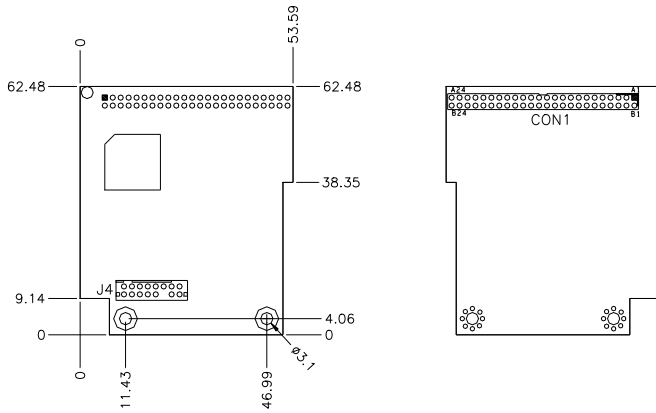

INSTALLATIONS

ID391 – J2 DVI Connector

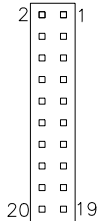

Signal Name	Pin #	Pin #	Signal Name
TDC1-	2	1	TDC1+
Ground	4	3	Ground
TLC-	6	5	TLC+
+5V	8	7	Ground
NC	10	9	HPDET
TDC2-	12	11	TDC2+
Ground	14	13	Ground
TDC0-	16	15	TDC0+
NC	18	17	NC
DDC_SC	20	19	DDC_SD

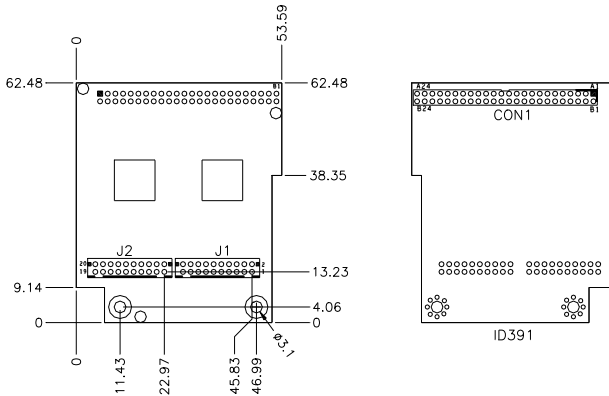

ID391D – J1, J2 1st/2nd DVI Connectors

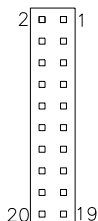

Signal Name	Pin #	Pin #	Signal Name
TDC1-	2	1	TDC1+
Ground	4	3	Ground
TLC-	6	5	TLC+
+5V	8	7	Ground
NC	10	9	HPDET
TDC2-	12	11	TDC2+
Ground	14	13	Ground
TDC0-	16	15	TDC0+
NC	18	17	NC
DDC_SC	20	19	DDC_SD

Remarks: When using dual DVI, the first DVI video output is through J1. After setting the drivers in Windows, then the second DVI output (via J2) will function. ID391D and ID391 are different since the latter (ID391) has video output via J2. The pin assignments of J1 and J2 are the same.

BIOS Setup

This chapter describes the different settings available in the Award BIOS that comes with the board. The topics covered in this chapter are as follows:

BIOS Introduction	26
BIOS Setup	26
Standard CMOS Setup.....	28
Advanced BIOS Features	31
Advanced Chipset Features	34
Integrated Peripherals	36
Power Management Setup	39
PNP/PCI Configurations.....	42
PC Health Status.....	43
Frequency/Voltage Control.....	44
Load Fail-Safe Defaults.....	45
Load Optimized Defaults.....	45
Set Supervisor/User Password.....	45
Save & Exit Setup.....	45
Exit Without Saving	45

BIOS Introduction

The Award BIOS (Basic Input/Output System) installed in your computer system's ROM supports Intel processors. The BIOS provides critical low-level support for a standard device such as disk drives, serial ports and parallel ports. It also adds virus and password protection as well as special support for detailed fine-tuning of the chipset controlling the entire system.

BIOS Setup

The Award BIOS provides a Setup utility program for specifying the system configurations and settings. The BIOS ROM of the system stores the Setup utility. When you turn on the computer, the Award BIOS is immediately activated. Pressing the key immediately allows you to enter the Setup utility. If you are a little bit late pressing the key, POST (Power On Self Test) will continue with its test routines, thus preventing you from invoking the Setup. If you still wish to enter Setup, restart the system by pressing the "Reset" button or simultaneously pressing the <Ctrl>, <Alt> and <Delete> keys. You can also restart by turning the system Off and back On again. The following message will appear on the screen:

Press to Enter Setup

In general, you press the arrow keys to highlight items, <Enter> to select, the <PgUp> and <PgDn> keys to change entries, <F1> for help and <Esc> to quit.

When you enter the Setup utility, the Main Menu screen will appear on the screen. The Main Menu allows you to select from various setup functions and exit choices.

Phoenix - AwardBIOS CMOS Setup Utility

Standard CMOS Features	Frequency/Voltage Control
Advanced BIOS Features	Load Fail-Safe Defaults
Advanced Chipset Features	Load Optimized Defaults
Integrated Peripherals	Set Supervisor Password
Power Management Setup	Set User Password
PnP/PCI Configurations	Save & Exit Setup
PC Health Status	Exit Without Saving
ESC : Quit	↑ ↓ → ← : Select Item
F10 : Save & Exit Setup	
Time, Date, Hard Disk Type...	

The section below the setup items of the Main Menu displays the control keys for this menu. At the bottom of the Main Menu just below the control keys section, there is another section, which displays information on the currently highlighted item in the list.

Note: *If the system cannot boot after making and saving system changes with Setup, the Award BIOS supports an override to the CMOS settings that resets your system to its default.*

Warning: *It is strongly recommended that you avoid making any changes to the chipset defaults. These defaults have been carefully chosen by both Award and your system manufacturer to provide the absolute maximum performance and reliability. Changing the defaults could cause the system to become unstable and crash in some cases.*

Standard CMOS Setup

“Standard CMOS Setup” choice allows you to record some basic hardware configurations in your computer system and set the system clock and error handling. If the motherboard is already installed in a working system, you will not need to select this option. You will need to run the Standard CMOS option, however, if you change your system hardware configurations, the onboard battery fails, or the configuration stored in the CMOS memory was lost or damaged.

Phoenix - AwardBIOS CMOS Setup Utility
Standard CMOS Features

Date (mm:dd:yy)	Wed, Apr 28, 2007	Item Help
Time (hh:mm:ss)	00 : 00 : 00	Menu Level >
IDE Channel 0 Master	None	Change the day, month, Year and century
IDE Channel 1 Slave	None	
IDE Channel 2 Master	None	
IDE Channel 2 Slave	None	
IDE Channel 3 Master	None	
IDE Channel 3 Slave	None	
IDE Channel 4 Master	None	
IDE Channel 4 Slave	None	
Video	EGA/VGA	
Halt On	All, But Keyboard	
Base Memory	640K	
Extended Memory	129024K	
Total Memory	130048K	

At the bottom of the menu are the control keys for use on this menu. If you need any help in each item field, you can press the <F1> key. It will display the relevant information to help you. The memory display at the lower right-hand side of the menu is read-only. It will adjust automatically according to the memory changed. The following describes each item of this menu.

Date

The date format is:

Day : Sun to Sat
Month : 1 to 12
Date : 1 to 31
Year : 1999 to 2099

To set the date, highlight the “Date” field and use the PageUp/ PageDown or +/- keys to set the current time.

Time

The time format is: **Hour** : 00 to 23
 Minute : 00 to 59
 Second : 00 to 59

To set the time, highlight the “Time” field and use the <PgUp>/ <PgDn> or +/- keys to set the current time.

IDE Channel Master/Slave

The onboard PCI IDE connector provides Primary and Secondary channels for connecting up to two IDE hard disks or other IDE devices.

Press <Enter> to configure the hard disk. The selections include Auto, Manual, and None. Select ‘Manual’ to define the drive information manually. You will be asked to enter the following items.

CYLS : Number of cylinders
HEAD : Number of read/write heads
PRECOMP : Write precompensation
LANDING ZONE : Landing zone
SECTOR : Number of sectors

The Access Mode selections are as follows:

CHS (HD < 528MB)
LBA (HD > 528MB and supports
 Logical Block Addressing)
Large (for MS-DOS only)
Auto

Remarks: The main board supports two serial ATA ports and are represented in this setting as IDE Channel 0.

Video

This field selects the type of video display card installed in your system.

You can choose the following video display cards:

EGA/VGA	For EGA, VGA, SEGA, SVGA or PGA monitor adapters. (default)
CGA 40	Power up in 40 column mode.
CGA 80	Power up in 80 column mode.
MONO	For Hercules or MDA adapters.

Halt On

This field determines whether or not the system will halt if an error is detected during power up.

No errors	The system boot will not be halted for any error that may be detected.
All errors	Whenever the BIOS detects a non-fatal error, the system will stop and you will be prompted.
All, But Keyboard	The system boot will not be halted for a keyboard error; it will stop for all other errors.
All, But Diskette	The system boot will not be halted for a disk error; it will stop for all other errors.
All, But Disk/Key	The system boot will not be halted for a keyboard or disk error; it will stop for all others.

Advanced BIOS Features

This section allows you to configure and improve your system and allows you to set up some system features according to your preference.

Phoenix - AwardBIOS CMOS Setup Utility
Advanced BIOS Features

		ITEM HELP
CPU Feature	Press Enter	
Hard Disk Boot Priority	Press Enter	
Virus Warning	Disabled	Menu Level >
CPU L3 Cache	Enabled	
Quick Power On Self Test	Enabled	
First Boot Device	Hard Disk	
Second Boot Device	CDROM	
Third Boot Device	USB-CDROM	
Boot Other Device	Enabled	
Boot Up NumLock Status	On	
Gate A20 Option	Fast	
Typematic Rate Setting	Disabled	
Typematic Rate (Chars/Sec)	6	
Typematic Delay (Msec)	250	
Security Option	Setup	
APIC Mode	Enabled	
MPS Version Control for OS	1.4	
OS Select For DRAM>64MB	Non-OS2	
Small Logo (EPA) Show	Disabled	
Summary Screen Show	Disabled	

CPU Feature

Press Enter to configure the settings relevant to CPU Feature.

Hard Disk Boot Priority

With the field, there is the option to choose, aside from the hard disks connected, “Bootable add-in Cards” which refers to other external devices.

Virus Warning

If this option is enabled, an alarm message will be displayed when trying to write on the boot sector or on the partition table on the disk, which is typical of the virus.

Quick Power On Self Test

When enabled, this field speeds up the Power On Self Test (POST) after the system is turned on. If it is set to *Enabled*, BIOS will skip some items.

First/Second/Third Boot Device

These fields determine the drive that the system searches first for an operating system. The options available include *Floppy*, *LS120*, *Hard Disk*, *CDROM*, *ZIP100*, *USB-Floppy*, *USB-ZIP*, *USB-CDROM*, *LAN* and *Disable*.

Boot Other Device

These fields allow the system to search for an OS from other devices other than the ones selected in the First/Second/Third Boot Device.

Boot Up NumLock Status

This allows you to activate the NumLock function after you power up the system.

Gate A20 Option

This field allows you to select how Gate A20 is worked. Gate A20 is a device used to address memory above 1 MB.

Typematic Rate Setting

When disabled, continually holding down a key on your keyboard will generate only one instance. When enabled, you can set the two typematic controls listed next. By default, this field is set to *Disabled*.

Typematic Rate (Chars/Sec)

When the typematic rate is enabled, the system registers repeated keystrokes speeds. Settings are from 6 to 30 characters per second.

Typematic Delay (Msec)

When the typematic rate is enabled, this item allows you to set the time interval for displaying the first and second characters. By default, this item is set to *250msec*.

Security Option

This field allows you to limit access to the System and Setup. The default value is *Setup*. When you select *System*, the system prompts for the User Password every time you boot up. When you select *Setup*, the system always boots up and prompts for the Supervisor Password only when the Setup utility is called up.

APIC Mode

APIC stands for Advanced Programmable Interrupt Controller. The default setting is *Enabled*.

MPS Version Control for OS

This option specifies the MPS (Multiprocessor Specification) version for your operating system. MPS version 1.4 added extended configuration tables to improve support for multiple PCI bus configurations and improve future expandability. The default setting is *1.4*.

OS Select for DRAM > 64MB

This option allows the system to access greater than 64MB of DRAM memory when used with OS/2 that depends on certain BIOS calls to access memory. The default setting is *Non-OS/2*.

Small Logo (EPA) Show

The EPA logo appears at the right side of the monitor screen when the system is boot up. The default setting is *Disabled*.

Advanced Chipset Features

This Setup menu controls the configuration of the chipset.

Phoenix - AwardBIOS CMOS Setup Utility
Advanced Chipset Features

		ITEM HELP
System BIOS Cacheable	Enabled	
Memory Hole at 15M-16M	Disabled	
PCI Express Root Port Func	Press Enter	
** VGA Setting **		
PEG/On Chip VGA Control	Auto	
PEG Force X1	Disabled	
On-Chip Frame Buffer Size	32MB	
DVMT Mode	DVMT	
DVMT/FIXED memory Size	128MB	
Boot Display	CRT+LVDS	
SDVO Device Setting	None	
SDVO LVDS Protocol	1CH SPWG, 18bit	
SDVO Panel Number	1024x768	
Active LVDS Device	No LVDS	
Panel Scaling	Auto	
Panel Number	1024x768 18 bit SC	

System BIOS Cacheable

The setting of *Enabled* allows caching of the system BIOS ROM at F000h-FFFFh, resulting in better system performance. However, if any program writes to this memory area, a system error may result.

Memory Hole At 15M-16M

In order to improve performance, certain space in memory can be reserved for ISA cards. This memory must be mapped into the memory space below 16 MB. The choices are *Enabled* and *Disabled*.

Note: *SDVO Device Setting, SDVO LVDS Protocol and SDVO Panel Number Selection fields are available when ID390, ID390C, ID391, ID391D or ID392 daughter cards are installed.*

On-Chip VGA Setting

The fields under the On-Chip VGA Setting and their default settings are:

PEG/On Chip VGA Control: Auto
PEG Force X1: Disabled
On-Chip Frame Buffer Size: 32MB
DVMT Mode: DVMT
DVMT/FIXED memory Size: 128MB
Boot Display: CRT+LVDS
SDVO Device Setting: None

Remarks: Set to LVDS for ID390, Set to CRT for ID390C, Set to DVI for ID391/ID392/ID391D/ID392D.

SDVO LVDS Protocol: 1CH SPWG, 18bit
SDVO Panel Number: 1024x768
Active LVDS Device: No LVDS
Panel Scaling: Auto
Panel Number: 1024x768 18 bit SC

Note: SDVO Device Setting, SDVO LVDS Protocol, SDVO Panel Number – for external device from connector CON1

Panel Scaling

The default setting is *Auto*. The options available include *On* and *Off*.

Panel Number

These fields allow you to select the LCD Panel type. The values for these ports are:

640x480	18bit SC
800x480	18bit SC
800x600	18bit SC
1024x768	18bit SC
1280x1024	18bit DC
1280x768	18bit SC
1400x1050	18bit DC
1600x1200	18bit DC

Integrated Peripherals

This section sets configurations for your hard disk and other integrated peripherals. The first screen shows three main items for user to select. Once an item selected, a submenu appears. Details follow.

Phoenix - AwardBIOS CMOS Setup Utility
Integrated Peripherals

OnChip IDE Device	Press Enter	ITEM HELP
Super IO Device	Press Enter	Menu Level >
2nd Super Device	Press Enter	
USB Device Setting	Press Enter	

Phoenix - AwardBIOS CMOS Setup Utility
OnChip IDE Device

IDE HDD Block Mode	Enabled	ITEM HELP
IDE DMA transfer access	Enabled	Menu Level >
IDE Primary Master PIO	Auto	
IDE Primary Slave PIO	Auto	
IDE Primary Master UDMA	Auto	
IDE Primary Slave UDMA	Auto	
On-Chip Secondary PCI IDE	Enabled	
IDE Secondary Master PIO	Auto	
IDE Secondary Slave PIO	Auto	
IDE Secondary Master UDMA	Auto	
IDE Secondary Slave UDMA	Auto	
SATA Mode	IDE	
LEGACY Mode Support	Enable	

IDE HDD Block Mode

This field allows your hard disk controller to use the fast block mode to transfer data to and from your hard disk drive.

IDE DMA transfer access

By default, this field is enabled.

IDE Primary/Secondary Master/Slave PIO

These fields allow your system hard disk controller to work faster. Rather than have the BIOS issue a series of commands that transfer to or from the disk drive, PIO (Programmed Input/Output) allows the BIOS to communicate with the controller and CPU directly.

The system supports five modes, numbered from 0 (default) to 4, which primarily differ in timing. When Auto is selected, the BIOS will select the best available mode.

IDE Primary/Secondary Master/Slave UDMA

These fields allow your system to improve disk I/O throughput to 33Mb/sec with the Ultra DMA/33 feature. The options are *Auto* and *Disabled*.

SATA Mode

The setting choices for the SATA Mode are IDE and AHCI Mode. Select [IDE] if you want to have SATA function as IDE. Select [AHCI] for Advanced Host Controller Interface (AHCI) feature, with improved SATA performance with native command queuing & native hot plug.

LEGACY Mode Support

When the Serial ATA (SATA) is set with the legacy mode enabled, then the SATA is set to the conventional IDE mode. Legacy mode is otherwise known as compatible mode.

Phoenix - AwardBIOS CMOS Setup Utility
SuperIO Device

POWER ON Function	BUTTON ONLY	ITEM HELP
KB Power ON Password	Enter	Menu Level >
Hot Key power ON	Ctrl-F1	
Onboard Serial Port 1	3F8/IRQ4	
Onboard Serial Port 2	2F8/IRQ3	
UART Mode Select	Normal	
PWRON After PWR-Fail	Off	

2nd Super IO Device

Onboard Serial Port 3	230	ITEM HELP
Serial Port 3 Use IRQ	IRQ5	Menu Level >
Onboard Serial Port 4	238	
Serial Port 4 Use IRQ	IRQ7	

Power ON Function

This field is related to how the system is powered on – such as with the use of conventional power button, keyboard or hot keys. The default is **BUTTON ONLY**.

KB Power ON Password

This field allows users to set the password when keyboard power on is the mode of the Power ON function.

Hot Key Power ON

This field sets certain keys, also known as hot keys, on the keyboard that can be used as a ‘switch’ to power on the system.

BIOS SETUP

Onboard Serial Port

These fields allow you to select the onboard serial ports and their addresses. The default values for these ports are:

Serial Port 1	3F8/IRQ4
Serial Port 2	2F8/IRQ3
Serial Port 3	230/IRQ5
Serial Port 4	238/IRQ7

UART Mode Select

This field determines the UART 2 mode in your computer. The default value is *Normal*.

PWRON After PWR-Fail

This field sets the system power status whether *on* or *off* when power returns to the system from a power failure situation.

Phoenix - AwardBIOS CMOS Setup Utility
USB Device Setting

		ITEM HELP
USB 1.0 Controller	Enabled	Menu Level >
USB 2.0 Controller	Enabled	
USB Keyboard Function	Enable	
USB Mouse Function	Disable	
USB Storage Function	Enabled	
*** USB Mass Storage Device Boot Setting ***		

USB 1.0 Controller

The options for this field are *Enabled* and *Disabled*. By default, this field is set to *Enabled*.

USB 2.0 Controller

The options for this field are *Enabled* and *Disabled*. By default, this field is set to *Enabled*. In order to use USB 2.0, necessary OS drivers must be installed first. *Please update your system to Windows 2000 SP4 or Windows XP SP2.*

USB Keyboard/Mouse/Storage Function

The options for this field are *Enabled* and *Disabled*. By default, this field is set to *Disabled*.

Power Management Setup

Phoenix - AwardBIOS CMOS Setup Utility
Power Management Setup

PCI Express PM Function	Press Enter	ITEM HELP
ACPI Function	Enabled	
ACPI Suspend	S3(STR)	Menu Level >
RUN VGABIOS if S3 Resume	Auto	
Power Management	User Define	
Video Off Method	V/H SYNC+ Blank	
Video Off In Suspend	Yes	
Suspend Type	Stop Grant	
Modem Use IRQ	3	
Suspend Mode	Disabled	
HDD Power Down	Disabled	
Soft-Off by PWR-BTTN	Instant-Off	
CPU THRM-Throttling	50.0%	
Wake-Up by PCI Card	Disabled	
Power On by Ring	Disabled	
Resume by Alarm	Disabled	
Date (of Month) Alarm	0	
Time (hh:mm:ss) Alarm	0 : 0 : 0	
** Reload Global Timer Events **		
Primary IDE 0	Disabled	
Primary IDE 1	Disabled	
Secondary IDE 0	Disabled	
Secondary IDE 1	Disabled	
FDD, COM, LPT Port	Disabled	
PCI PIRQ[A-D] #	Disabled	
HPET Support	Disabled	
HPET Mode	32-bit mode	

ACPI Function

Enable this function to support ACPI (Advance Configuration and Power Interface).

ACPI Suspend

The default setting of the ACPI Suspend mode is *S3(POS)*.

RUN VGABIOS if S3 Resume

The default setting of this field is *Auto*.

Power Management

This field allows you to select the type of power saving management modes. There are four selections for Power Management.

- | | |
|-------------------|---|
| Min. Power Saving | Minimum power management |
| Max. Power Saving | Maximum power management. |
| User Define | Each of the ranges is from 1 min. to 1hr.
Except for HDD Power Down which
ranges from 1 min. to 15 min. |

Video Off Method

This field defines the Video Off features. There are three options.

V/H SYNC + Blank	Default setting, blank the screen and turn off vertical and horizontal scanning.
DPMS	Allows BIOS to control the video display.
Blank Screen	Writes blanks to the video buffer.

Video Off In Suspend

When enabled, the video is off in suspend mode. The default setting is *Yes*.

Suspend Type

The default setting for the Suspend Type field is *Stop Grant*.

Modem Use IRQ

This field sets the IRQ used by the Modem. By default, the setting is *3*.

Suspend Mode

When enabled, and after the set time of system inactivity, all devices except the CPU will be shut off.

HDD Power Down

When enabled, and after the set time of system inactivity, the hard disk drive will be powered down while all other devices remain active.

Soft-Off by PWRBTN

This field defines the power-off mode when using an ATX power supply. The *Instant Off* mode allows powering off immediately upon pressing the power button. In the *Delay 4 Sec* mode, the system powers off when the power button is pressed for more than four seconds or enters the suspend mode when pressed for less than 4 seconds.

Wake up by PCI Card

By default, this field is disabled.

Power On by Ring

This field enables or disables the power on of the system through the modem connected to the serial port or LAN.

Resume by Alarm

This field enables or disables the resumption of the system operation. When enabled, the user is allowed to set the *Date* and *Time*.

Reload Global Timer Events

The HDD, FDD, COM, LPT Ports, and PCI PIRQ are I/O events that can prevent the system from entering a power saving mode or can awaken the system from such a mode. When an I/O device wants to gain the attention of the operating system, it signals this by causing an IRQ to occur. When the operating system is ready to respond to the request, it interrupts itself and performs the service.

PNP/PCI Configurations

This option configures the PCI bus system. All PCI bus systems on the system use INT#, thus all installed PCI cards must be set to this value.

Phoenix - AwardBIOS CMOS Setup Utility
PnP/PCI Configurations

		ITEM HELP
Init Display First	PCI Slot	Menu Level Select Yes if you are using a Plug and Play capable operating system Select No if you need the BIOS to configure non-boot devices
Reset Configuration Data	Disabled	
Resources Controlled By	Auto (ESCD)	
IRQ Resources	Press Enter	
PCI/VGA Palette Snoop	Disabled	
PCI Express relative items		
Maximum Payload Size	4096	

Init Display First

The default setting is *PCI Card*.

Reset Configuration Data

This field allows you to determine whether to reset the configuration data or not. The default value is *Disabled*.

Resources Controlled by

This PnP BIOS can configure all of the boot and compatible devices with the use of a PnP operating system such as Windows 95.

PCI/VGA Palette Snoop

Some non-standard VGA display cards may not show colors properly. This field allows you to set whether or not MPEG ISA/VESA VGA cards can work with PCI/VGA. When this field is enabled, a PCI/VGA can work with an MPEG ISA/VESA VGA card. When this field is disabled, a PCI/VGA cannot work with an MPEG ISA/VESA card.

Maximum Payload Size

The default setting of the PCI Express Maximum Payload Size is 4096.

PC Health Status

This section shows the parameters in determining the PC Health Status. These parameters include temperatures, fan speeds and voltages.

Phoenix - AwardBIOS CMOS Setup Utility
PC Health Status

		ITEM HELP
Shutdown Temperature	Disabled	Menu Level >
CPU Warning Temperature	Disabled	
Current System Temp	45°C/113°F	
Current CPU Temp	45°C/113°F	
Current Chassis Temp	45°C/113°F	
System FAN Speed	5400 RPM	
CPU FAN Speed	5400 RPM	
Vcore(V)	1.02 V	
12 V	1.32 V	
1.8V	1.8V	
+5V	5.25 V	
3.3V	3.37V	
VBAT (V)	3.21 V	
5VSB(V)	5.67 V	
CPU0 Smart Fan Temperature	Disabled	
CPU1 Smart Fan Temperature	Disabled	

CPU Warning Temperature

This field allows the user to set the temperature so that when the temperature is reached, the system sounds a warning. This function can help prevent damage to the system that is caused by overheating.

Temperatures/Voltages

These fields are the parameters of the hardware monitoring function feature of the motherboard. The values are read-only values as monitored by the system and show the PC health status.

Shutdown Temperature

This field allows the user to set the temperature by which the system automatically shuts down once the threshold temperature is reached. This function can help prevent damage to the system that is caused by overheating.

1st 2st Smart Fan Temperature

This field enables or disables the smart fan feature. At a certain temperature, the fan starts turning. Once the temperature drops to a certain level, it stops turning again.

Frequency/Voltage Control

This section shows the user how to configure the processor frequency.

Phoenix - AwardBIOS CMOS Setup Utility
Frequency/Voltage Control

Auto Detect PCI Clk	Disabled	ITEM HELP
Spread Spectrum Modulated	Disabled	Menu Level >

Auto Detect PCI Clk

This field enables or disables the auto detection of the PCI clock.

Spread Spectrum Modulated

This field sets the value of the spread spectrum. The default setting is *Disabled*. This field is for CE testing use only.

Load Fail-Safe Defaults

This option allows you to load the troubleshooting default values permanently stored in the BIOS ROM. These default settings are non-optimal and disable all high-performance features.

Load Optimized Defaults

This option allows you to load the default values to your system configuration. These default settings are optimal and enable all high performance features.

Set Supervisor Password

These two options set the system password. Supervisor Password sets a password that will be used to protect the system and Setup utility. User Password sets a password that will be used exclusively on the system. To specify a password, highlight the type you want and press <Enter>. The Enter Password: message prompts on the screen. Type the password, up to eight characters in length, and press <Enter>. The system confirms your password by asking you to type it again. After setting a password, the screen automatically returns to the main screen.

To disable a password, just press the <Enter> key when you are prompted to enter the password. A message will confirm the password to be disabled. Once the password is disabled, the system will boot and you can enter Setup freely.

Save & Exit Setup

This option allows you to determine whether or not to accept the modifications. If you type “Y”, you will quit the setup utility and save all changes into the CMOS memory. If you type “N”, you will return to Setup utility.

Exit Without Saving

Select this option to exit the Setup utility without saving the changes you have made in this session. Typing “Y” will quit the Setup utility without saving the modifications. Typing “N” will return you to Setup utility.

This page is intentionally left blank.

Drivers Installation

This section describes the installation procedures for software and drivers under the Windows 2000 and Windows XP. The software and drivers are included with the motherboard. If you find the items missing, please contact the vendor where you made the purchase. The contents of this section include the following:

Intel Chipset Software Installation Utility	48
VGA Drivers Installation.....	50
AC97 Codec Audio Driver Installation	52
LAN Drivers Installation	53

IMPORTANT NOTE:

After installing your Windows operating system (Windows 2000/ XP), you must install first the Intel Chipset Software Installation Utility before proceeding with the drivers installation.

Intel Chipset Software Installation Utility

The Intel Chipset Drivers should be installed first before the software drivers to enable Plug & Play INF support for Intel chipset components. Follow the instructions below to complete the installation.

1. Insert the CD that comes with the board. Click **Intel** and then **Intel(R) GM45 Chipset Drivers**.

2. Click **Intel(R) Chipset Software Installation Utility**.



3. When the Welcome screen to the Intel® Chipset Device Software appears, click **Next** to continue.

4. Click ***Yes*** to accept the software license agreement and proceed with the installation process.
5. On the Readme File Information screen, click ***Next*** to continue the installation.
6. The Setup process is now complete. Click ***Finish*** to restart the computer and for changes to take effect.

VGA Drivers Installation

To install the VGA drivers, follow the steps below to proceed with the installation.

1. Insert the CD that comes with the board. Click *Intel* and then *Intel(R) GM45 Chipset Drivers*.
2. Click *Intel(R) GM45 Chipset Family Graphics Driver*.



3. When the Welcome screen to the Setup Program appears, click *Next* to continue.



4. Click **Yes** to to agree with the license agreement and continue the installation.
5. On the Readme File Information screen, click **Next** to continue the installation of the Intel® Graphics Media Accelerator Driver.
6. On Setup Progress screen, click **Next** to continue.
7. Setup complete. Click **Finish** to restart the computer and for changes to take effect.



AC97 Codec Audio Driver Installation

Follow the steps below to install the Realtek AC97 Codec Audio Drivers.

1. Insert the CD that comes with the board. Click **Intel** and then **Intel(R) GM45 Chipset Drivers**.
2. Click **Realtek High Definition Code Audio Driver**.

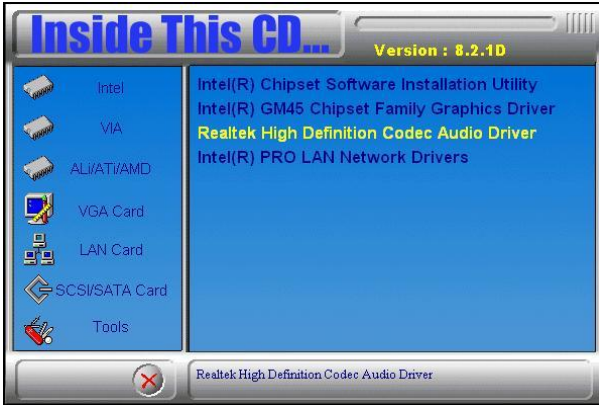

3. On the Welcome to the InstallShield Wizard screen, click **Next**.

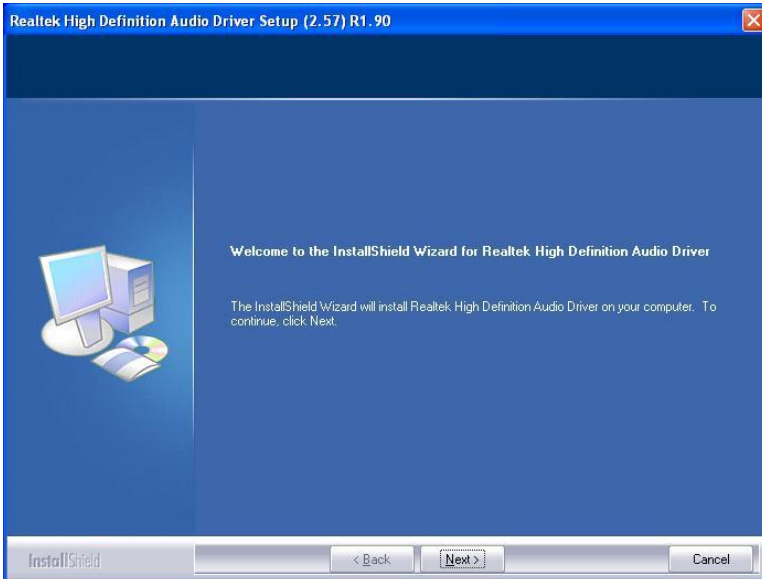

3. InstallShield Wizard is complete. Click **Finish** to restart the computer.

LAN Drivers Installation

Follow the steps below to install the Intel LAN drivers. *This one installation will cover both 82574L and 82567LM LAN controllers.*

1. Insert the CD that comes with the motherboard. Click **LAN Card** and then **Intel(R) PRO 82574L LAN Drivers**.



2. When the Welcome screen to the InstallShield Wizard for Intel® Network Connections appears, click **Next**. On the next screen, click **Yes** to agree with the license agreement.

3. Click the checkbox for **Drivers** in the Setup Options screen to select it and click **Next** to continue.

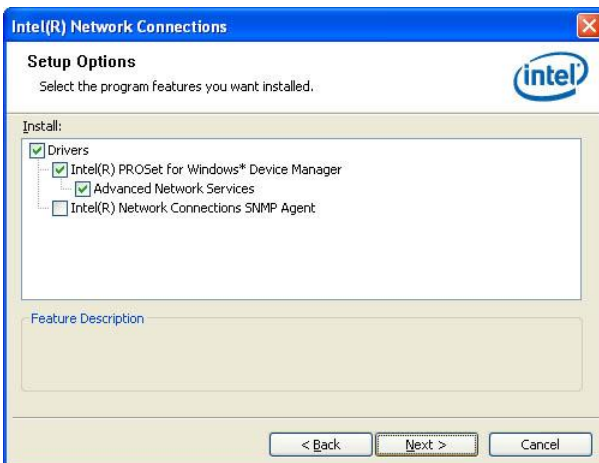

4. The wizard is ready to begin installation. Click **Install** to begin the installation.

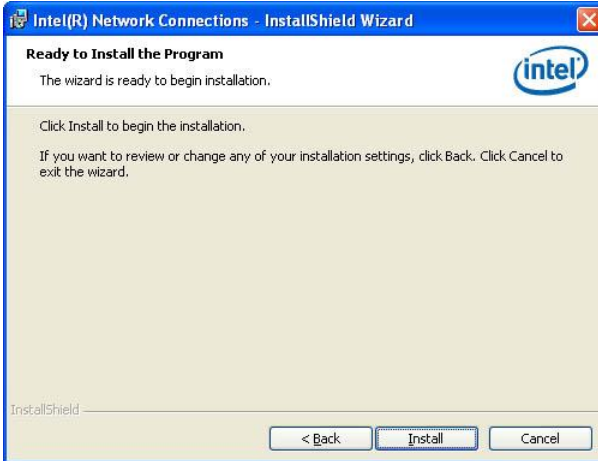

5. When InstallShield Wizard is complete, click **Finish**.

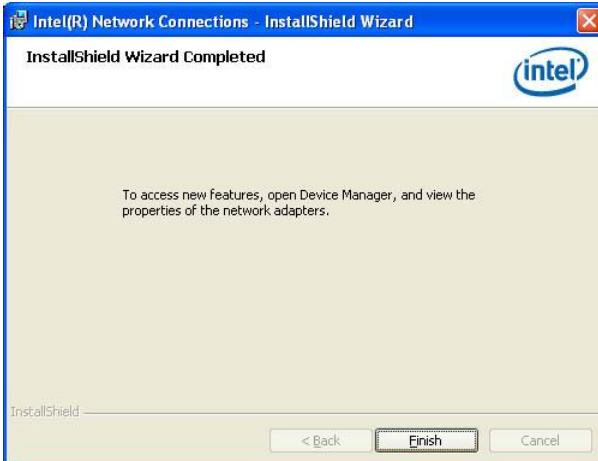

Remarks: This Intel® PRO 82574L LAN drivers support both Intel 82574L and 82567LM LAN controllers.

Appendix

A. I/O Port Address Map

Each peripheral device in the system is assigned a set of I/O port addresses which also becomes the identity of the device. The following table lists the I/O port addresses used.

Address	Device Description
000h - 01Fh	DMA Controller #1
020h - 03Fh	Interrupt Controller #1
040h - 05Fh	Timer
060h - 06Fh	Keyboard Controller
070h - 07Fh	Real Time Clock, NMI
080h - 09Fh	DMA Page Register
0A0h - 0BFh	Interrupt Controller #2
0C0h - 0DFh	DMA Controller #2
0F0h	Clear Math Coprocessor Busy Signal
0F1h	Reset Math Coprocessor
1F0h - 1F7h	IDE Interface
278 - 27F	Parallel Port #2(LPT2)
2F8h - 2FFh	Serial Port #2(COM2)
2B0 - 2DF	Graphics adapter Controller
378h - 3FFh	Parallel Port #1(LPT1)
360 - 36F	Network Ports
3B0 - 3BF	Monochrome & Printer adapter
3C0 - 3CF	EGA adapter
3D0 - 3DF	CGA adapter
3F0h - 3F7h	Floppy Disk Controller
3F8h - 3FFh	Serial Port #1(COM1)

B. Interrupt Request Lines (IRQ)

Peripheral devices use interrupt request lines to notify CPU for the service required. The following table shows the IRQ used by the devices on board.

Level	Function
IRQ0	System Timer Output
IRQ1	Keyboard
IRQ2	Interrupt Cascade
IRQ3	Serial Port #2
IRQ4	Serial Port #1
IRQ5	Reserved
IRQ6	Floppy Disk Controller
IRQ7	Parallel Port #1
IRQ8	Real Time Clock
IRQ9	Reserved
IRQ10	Reserved
IRQ11	Reserved
IRQ12	PS/2 Mouse
IRQ13	80287
IRQ14	Primary IDE
IRQ15	Secondary IDE

C. Watchdog Timer Configuration

The WDT is used to generate a variety of output signals after a user programmable count. The WDT is suitable for use in the prevention of system lock-up, such as when software becomes trapped in a deadlock. Under these sorts of circumstances, the timer will count to zero and the selected outputs will be driven. Under normal circumstance, the user will restart the WDT at regular intervals before the timer counts to zero.

SAMPLE CODE:

```

=====
//
// THIS CODE AND INFORMATION IS PROVIDED "AS IS" WITHOUT WARRANTY OF ANY
// KIND, EITHER EXPRESSED OR IMPLIED, INCLUDING BUT NOT LIMITED TO THE
// IMPLIED WARRANTIES OF MERCHANTABILITY AND/OR FITNESS FOR A PARTICULAR
// PURPOSE.
//
=====
#include <stdio.h>
#include <stdlib.h>
#include "W627DHG.H"
=====
int main (int argc, char *argv[])
void copyright(void);
void EnableWDT(int);
void DisableWDT(void);
=====
int main (int argc, char *argv[])
{
    unsigned char bBuf;
    unsigned char bTime;
    char **endptr;

    copyright();

    if (argc != 2)
    {
        printf(" Parameter incorrect!!\n");
        return 1;
    }

    if (Init_W627DHG() == 0)
    {
        printf(" Winbond 83627HF is not detected, program abort.\n");
        return 1;
    }
    bTime = strtol (argv[1], endptr, 10);
    printf("System will reset after %d seconds\n", bTime);

    EnableWDT(bTime);

    return 0;
}
=====

```

APPENDIX

```
void copyright(void)
{
    printf("\n===== Winbond 83627DHG Watch Timer Tester (AUTO DETECT) =====\n")
        " Usage : W627E_WD reset_time\n"
        " Ex : W627E_WD 3 => reset system after 3 second\n"
        " W627E_WD 0 => disable watch dog timer\n");
}
//=====
void EnableWDT(int interval)
{
    unsigned char bBuf;

    bBuf = Get_W627DHG_Reg( 0x2D);
    bBuf &= (!0x01);
    Set_W627DHG_Reg( 0x2D, bBuf); //Enable WDTO

    Set_W627DHG_LD( 0x08); //switch to logic device 8
    Set_W627DHG_Reg( 0x30, 0x01); //enable timer

    bBuf = Get_W627DHG_Reg( 0xF5);
    bBuf &= (!0x08);
    Set_W627DHG_Reg( 0xF5, bBuf); //count mode is second

    Set_W627DHG_Reg( 0xF6, interval); //set timer
}
//=====
void DisableWDT(void)
{
    Set_W627DHG_LD(0x08); //switch to logic device 8
    Set_W627DHG_Reg(0xF6, 0x00); //clear watchdog timer
    Set_W627DHG_Reg(0x30, 0x00); //watchdog disabled
}
//=====
```

```

=====
//
// THIS CODE AND INFORMATION IS PROVIDED "AS IS" WITHOUT WARRANTY OF ANY
// KIND, EITHER EXPRESSED OR IMPLIED, INCLUDING BUT NOT LIMITED TO THE
// IMPLIED WARRANTIES OF MERCHANTABILITY AND/OR FITNESS FOR A PARTICULAR
// PURPOSE.
//
=====
#include "W627DHG.H"
#include <dos.h>
=====
unsigned int W627DHG_BASE;
void Unlock_W627DHG (void);
void Lock_W627DHG (void);
=====
unsigned int Init_W627DHG(void)
{
    unsigned int result;
    unsigned char ucDid;

    W627DHG_BASE = 0x2E;
    result = W627DHG_BASE;

    ucDid = Get_W627DHG_Reg(0x20);
    if (ucDid == 0x88)
    {
        goto Init_Finish;
    }

    W627DHG_BASE = 0x4E;
    result = W627DHG_BASE;
    ucDid = Get_W627DHG_Reg(0x20);
    if (ucDid == 0x88)
    {
        goto Init_Finish;
    }

    W627DHG_BASE = 0x00;
    result = W627DHG_BASE;

Init_Finish:
    return (result);
}
=====
void Unlock_W627DHG (void)
{
    outportb(W627DHG_INDEX_PORT, W627DHG_UNLOCK);
    outportb(W627DHG_INDEX_PORT, W627DHG_UNLOCK);
}
=====
void Lock_W627DHG (void)
{
    outportb(W627DHG_INDEX_PORT, W627DHG_LOCK);
}
=====
void Set_W627DHG_LD( unsigned char LD)
{
    Unlock_W627DHG();
    outportb(W627DHG_INDEX_PORT, W627DHG_REG_LD);
    outportb(W627DHG_DATA_PORT, LD);
    Lock_W627DHG();
}

```

APPENDIX

```
=====
void Set_W627DHG_Reg( unsigned char REG, unsigned char DATA)
{
    Unlock_W627DHG();
    outportb(W627DHG_INDEX_PORT, REG);
    outportb(W627DHG_DATA_PORT, DATA);
    Lock_W627DHG();
}
=====
unsigned char Get_W627DHG_Reg(unsigned char REG)
{
    unsigned char Result;
    Unlock_W627DHG();
    outportb(W627DHG_INDEX_PORT, REG);
    Result = inportb(W627DHG_DATA_PORT);
    Lock_W627DHG();
    return Result;
}
=====

=====
//
// THIS CODE AND INFORMATION IS PROVIDED "AS IS" WITHOUT WARRANTY OF ANY
// KIND, EITHER EXPRESSED OR IMPLIED, INCLUDING BUT NOT LIMITED TO THE
// IMPLIED WARRANTIES OF MERCHANTABILITY AND/OR FITNESS FOR A PARTICULAR
// PURPOSE.
//
//=====
#ifndef __W627DHG_H
#define __W627DHG_H                1
//=====
#define W627DHG_INDEX_PORT        (W627DHG_BASE)
#define W627DHG_DATA_PORT        (W627DHG_BASE+1)
//=====
#define W627DHG_REG_LD            0x07
//=====
#define W627DHG_UNLOCK            0x87
#define W627DHG_LOCK              0xAA
//=====
unsigned int Init_W627DHG(void);
void Set_W627DHG_LD( unsigned char);
void Set_W627DHG_Reg( unsigned char, unsigned char);
unsigned char Get_W627DHG_Reg( unsigned char);
//=====
#endif // __W627DHG_H
```