

IB530F/IB530 Series

AMD Geode LX
3.5-inch Disk Size SBC

USER'S MANUAL

Version 1.0

Acknowledgments

Award is a registered trademark of Award Software International, Inc.

PS/2 is a trademark of International Business Machines Corporation.

AMD, AMD Geode, and combinations thereof, are trademarks of Advanced Micro Devices, Inc.

Microsoft Windows is a registered trademark of Microsoft Corporation.

All other product names or trademarks are properties of their respective owners.

Table of Contents

Introduction	1
Product Description.....	1
Checklist.....	2
Specifications	3
Board Dimensions	4
Installations	5
Installing the Memory	6
Setting the Jumpers	7
Connectors on IB530F	10
BIOS Setup.....	19
Drivers Installation	35
Entertainment Encryption/Decryption Controller Driver..	36
VGA Drivers Installation	38
Audio Driver Installation	41
PCI Bridge Driver Installation	44
Appendix	47
A. I/O Port Address Map.....	47
B. Interrupt Request Lines (IRQ)	48
C. Watchdog Timer Configuration.....	49

This page is intentionally left blank.

Introduction

Product Description

The IB530F 3.5-inch disk size SBC incorporates the AMD Geode LX processor with speeds of 433MHz (LX700), 500MHz (LX800) or 600MHz (LX900). It comes with one DDR SO-DIMM socket that has a capacity of 1GB system memory. The board supports two 10/100Mbps Ethernet, using Realtek RTL8100C controllers. A 2D graphics controller comes integrated on the board that supports CRT and TFT LCD displays. Useful interface includes four USB 2.0 ports, 4 COM ports, and one PC-104 expansion slot (Non-DMA ISA ONLY, PCI not supported). Other expansion options are available with the Compact Flash socket.

IB530F FEATURES:

- Embedded AMD Geode LX processor, 433MHz (LX700) / 500MHz (LX800), 600MHz (LX900).
- DDR SO-DIMM x 1, Max. 1GB
- Realtek RTL8100C 10/100Mbps Ethernet x2
- Integrated LX800/LX700 2D VGA controller, supports CRT and TFT LCD display
- 4 x USB 2.0, 4 x COM, CF socket, Watchdog timer, Digital I/O
- PC-104 expansion (Non-DMA ISA only, PCI not supported)
- Dimensions: 145mm x 102mm (5.7" x 4")

Checklist

Your IB530F package should include the items listed below.

- The IB530F AMD Geode LX 3.5-inch Disk Size SBC
- This User's Manual
- 1 CD containing chipset drivers and flash memory utility
- Heatsink for AMD Geode LX processor
- Options:
 - cable kit (IDE, COM, PS/2, LPT, USB, Audio, Power cable)

Specifications

CPU	AMD Geode LX CPU, 481-ball BGA
CPU Internal Speed	LX800 @500MHz LX700 @433MHz LX900@600MHz
Power Management	APM
BIOS	Award BIOS
Chipset	AMD CS5536 I/O companion multi-function south bridge
Memory	One DDR SO-DIMM socket, Max. up to 1GB
Graphic	LX900/LX800/LX700 built-in high performance 2D graphic controller, supports TFT, LVDS LCD & CRT display
LVDS	18-bit single channel LVDS
Ethernet	2x Realtek RTL8100C-LF 10/100Mbps Ethernet chip
IDE	CS5536 built-in one channel UDMA100 IDE - 44-pin header x1 - Compact Flash (type II) connector x1
Audio	Realtek ALC203 AC97 audio codec, supports 2-CH Line-Out, Line-In & MIC
USB	CS5536 built-in USB2.0 controller, support 4 ports
LPC I/O	Winbond W83627HF: KB/Mouse controller, Parallel, IrDA, Floppy, COM1, COM2 (RS232) & Hardware monitor (3 thermal inputs, 4 voltage monitor inputs, VID0-4 & 2 Fan Headers) Fintek 81216 for COM3/COM4
Secondary I/O	
PCI Arbiter	IT8209R PCI arbiter/clock buffer, extend PCI devices (master) from 1 to 3
RTC	CS5536 built-in, with on board Lithium battery
Edge Connectors	DB-9 connector x1 for COM1 (RS232 only) DB-15 connector x1 for CRT RJ-45 connector x2 for LAN
Onboard Headers	6-pin header x1 for PS/2 KB/Mouse (Y cable) DF13-20 header x1 for LVDS channel Compact Flash Socket x1 for CF card 10-pin header x1 for COM1 (RS232 only) 30-pin header x1 for COM2/3/4 8-pin header for USB0, 1 8-pin header x1 for USB2, 3 26-pin header x1 for LPT port 44-pin header x1 for IDE 26-pin header x1 for FDD 12-pin header x1 for Audio 4-pin header x1 for IrDA 10-pin header x1 for Digital I/O 44-pin header x1 for TFT LCD panel
Expansion Slot	PC-104 w/ 4 mounting holes(Non DMA ISA ONLY,Not support PCI)
Digital I/O	Supports 4 In / 4 Out
Power	+12V DC-in
Watchdog Timer	Software programmable, supports 1~255 sec. system reset
RoHS Compliant	Yes
Board Size	145 x 102mm

Board Dimensions

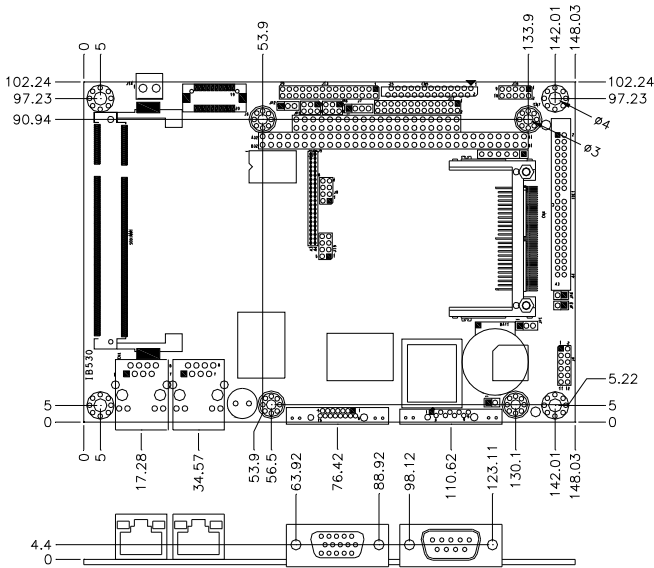

Installations

This section provides information on how to use the jumpers and connectors on the IB530F in order to set up a workable system. The topics covered are:

Installing the Memory	6
Setting the Jumpers	7
Connectors on IB530F	10

Installing the Memory

The IB530F board supports one SODIMM DDR memory socket for a maximum total memory. The memory module capacities supported are 128MB, 256MB, 512MB and 1GB.

Installing and Removing Memory Modules

To install the DDR modules, locate the memory slot on the board and perform the following steps:

1. Hold the DDR module so that the keys of the DDR module align with those on the memory slot. Insert the module into the socket at a slight angle (approximately 30 degrees). Note that the socket and module are both keyed, which means that the module can be installed only in one direction.
2. To seat the memory module into the socket, apply firm and even pressure to each end of the module until you feel it slip down into the socket.
3. With the module properly seated in the socket, rotate the module downward. Continue pressing downward until the clips at each end lock into position.
4. To remove the DDR module, press the clips with both hands.

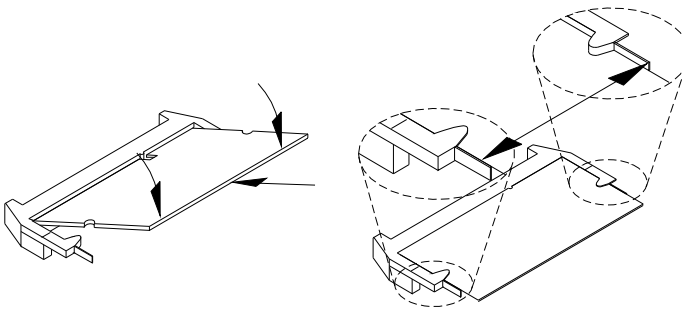

Setting the Jumpers

Jumpers are used on IB530F to select various settings and features according to your needs and applications. Contact your supplier if you have doubts about the best configuration for your needs. The following lists the connectors on IB530F and their respective functions.

Jumper Locations on IB530F	8
JP1: Clear CMOS Setting	9
JP2: LVDS VDD Select (5V / 3.3V).....	9
JP3: HDD LED Pin Header.....	9
JP4: CF Connector master/Slave Setting.....	9
JP5, JP6: COM3,4 RS232 +5V/+12V Power Setting.....	9

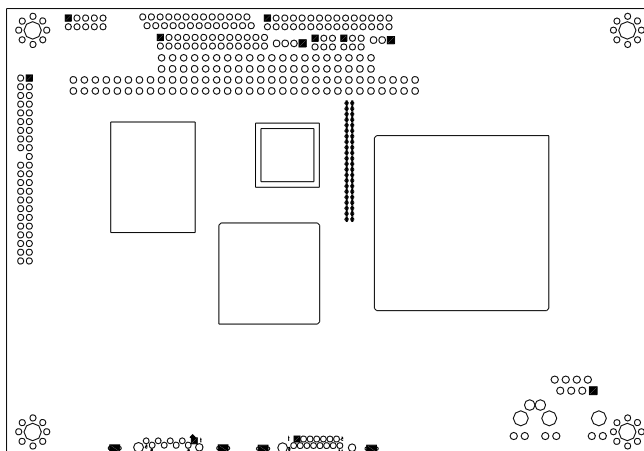
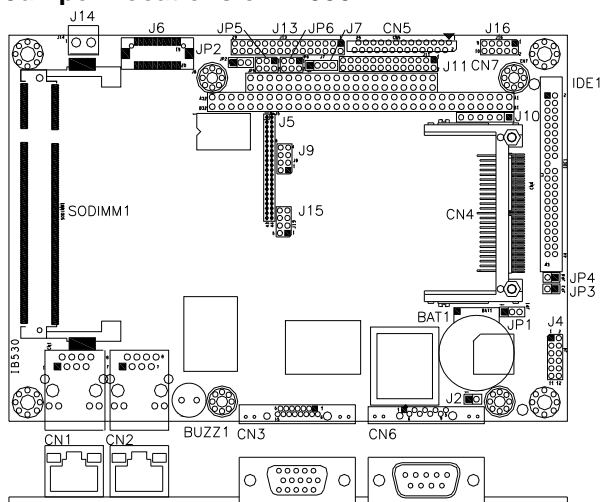

Jumper Locations on IB530F





Jumpers on IB530F.....	Page
Jumper Locations on IB530F.....	8
JP1: Clear CMOS Setting	9
JP2: LVDS VDD Select (5V / 3.3V)	9
JP3: HDD LED Pin Header	9
JP4: CF Connector master/Slave Setting	9
JP5, JP6: COM3,4 RS232 +5V/+12V Power Setting	9

JP1: Clear CMOS Setting

Use JP1 to clear the CMOS contents. *Note that the power connector should be disconnected from the board before clearing CMOS.*

JP1	Function
	Normal (default)
	Clear CMOS

JP2: LVDS VDD Select (5V / 3.3V)



JP2	VDD Setting
	3.3V
	5V

JP3: HDD LED Pin Header



Pin #	Signal Name
1	VCC
2	HDD_LED-

JP4: CF Connector master/Slave Setting

JP4	Setting	Function
	Short/Closed	Master
	Open	Slave

JP5, JP6: COM3,4 RS232 +5V/+12V Power Setting

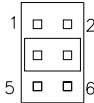
JP5, JP6	Setting	Function
	Pin 1-2 Short/Closed	+12V
	Pin 3-4 Short/Closed	Normal
	Pin 5-6 Short/Closed	+5V

Connectors on IB530F

The connectors on IB530F allows you to connect external devices such as keyboard, floppy disk drives, hard disk drives, printers, etc. The following table lists the connectors on IB530F and their respective functions.

Connector Locations on IB530F.....	11
CN1, CN2: RJ45 Connector	12
CN3: VGA CRT Connector.....	12
CN4: Compact Flash Card Socket	12
CN5: FDD Connector	12
CN6, J13: Serial port	13
CN6 is the D-sub type COM1 serial port connector.....	13
CN7: PC-104 Connector.....	14
J2: Reset Switch.....	15
J4: External Audio Connector	15
J5: TFT Panel Connector	15
J6: LVDS Connectors	16
J7: IrDA Connector	16
J9, J15: USB Connectors	16
J10: PS/2 Keyboard and Mouse Connector	16
J11: Parallel Port Connector	17
J14: Power DC-In	17
J16: Digital 4-in 4-out Connector	17
IDE1: IDE Connector	18
SODIMM1: SO DIMM Socket	18

Connector Locations on IB530F

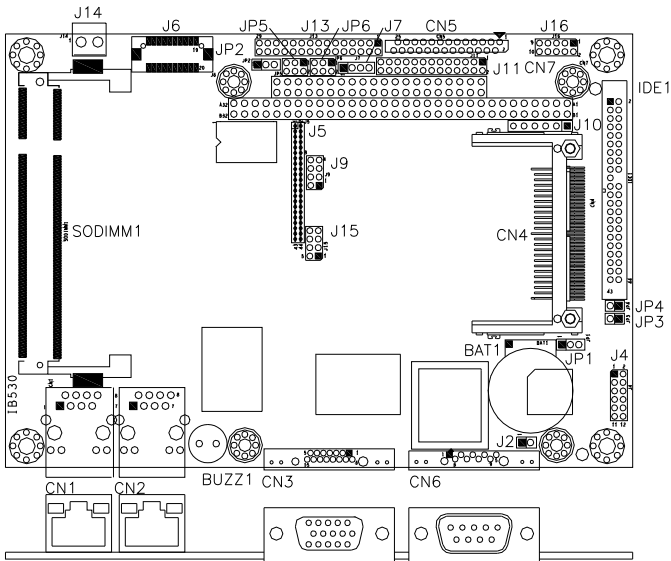

Connectors on IB530F.....	Page
CN1, CN2: RJ45 Connector.....	12
CN3: VGA CRT Connector.....	12
CN4: Compact Flash Card Socket.....	12
CN5: FDD Connector.....	12
CN6, J13: Serial Ports.....	13
CN7: PC-104 Connector (Non DMA ISA ONLY,Not Support PCI).....	14
J2: Reset Switch.....	15
J4: External Audio Connector.....	15
J5: TFT Panel Connector.....	15
J6: LVDS Connectors.....	16
J7: IrDA Connector.....	16
J9, J15: USB Connectors.....	16
J10: PS/2 Keyboard and Mouse Connector.....	16
J11: Parallel Port Connector.....	17
J14: Power DC-In.....	17
J16: Digital 4-in 4-out Connector.....	17
IDE1: IDE Connector.....	18
SODIMM1: SO DIMM Socket.....	18

CN1, CN2: RJ45 Connector

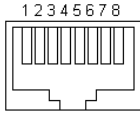

Pin #	Signal Name
1	TD+
2	TD-
3	RD+
4	RJ45-4A
5	RJ45-5A
6	RD-
7	RJ45-7A
8	RJ45-8A

CN3: VGA CRT Connector

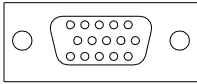

Signal Name	Pin	Pin	Signal Name
Red	1	2	Green
Blue	3	4	NC
GND	5	6	GND
GND	7	8	GND
Vcc	9	10	GND
N.C.	11	12	DDCDA
HSYNC	13	14	VSYNC
DDCCLK	15		

CN4: Compact Flash Card Socket

CN5: FDD Connector

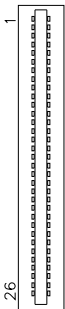

Signal Name	Pin #	Pin #	Signal Name
VCC	1	2	INDEX
VCC	3	4	DRV_SEL
VCC	5	6	DSK_CH
NC	7	8	NC
NC	9	10	MOTOR
DINST	11	12	DIR
NC	13	14	STEP
GND	15	16	WDATA
GND	17	18	WGATE
GND	19	20	TRACK
NC	21	22	WPROT
GND	23	24	RDATA
GND	25	26	SIDE

CN6, J13: Serial port

CN6 is the D-sub type COM1 serial port connector

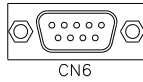

Pin #	Signal Name (RS-232)
1	DCD, Data carrier detect
2	RXD, Receive data
3	TXD, Transmit data
4	DTR, Data terminal ready
5	Ground
6	DSR, Data set ready
7	RTS, Request to send
8	CTS, Clear to send
9	RI, Ring indicator

J13 (COM2/3/4) is a 30-pin header type COM2/3/4 serial port (RS232) connector.

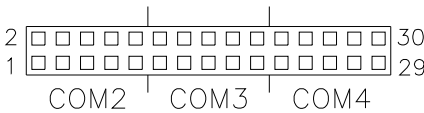

Signal Name	Pin #	Pin #	Signal Name
DCD2	1	2	DSR2
SIN2	3	4	RTS2
SO2	5	6	CTS2
DTR2-	7	8	RI2
GND	9	10	N/A
DCD3	11	12	DSR3
SIN3	13	14	RTS3
SOUT3	15	16	CTS3
DTR3	17	18	RI3-
GND	19	20	N/A
DCD4	21	22	DSR4
SIN4	23	24	RTS4
SOUT4	25	26	CTS4
DTR4	27	28	RI4
GND	29	30	Protect pin

CN7: PC-104 Connector

The PC-104 connector* is a dual-in-line pin headers that support PC-104 ISA modules, with 64 pins and 40 pins in each line. The following table shows the their pin assignments. *(Non-DMA ISA ONLY)

CON1				CON2			
Pin	Signal Name	Pin	Signal Name	Pin	Signal Name	Pin	Signal Name
A1	IOCHK	B1	GND	C1	GND	D1	GND
A2	D7	B2	REST	C2	SBHE	D2	MEMCS16
A3	D6	B3	VCC	C3	LA23	D3	IOCS16
A4	D5	B4	IRQ9	C4	LA22	D4	IRQ10
A5	D4	B5	-5V	C5	LA21	D5	IRQ11
A6	D3	B6	DRQ2	C6	LA20	D6	IRQ12
A7	D2	B7	-12V	C7	LA19	D7	IRQ15
A8	D1	B8	OVS	C8	LA18	D8	IRQ14
A9	D0	B9	+12V	C9	LA17	D9	DACK0
A10	IOCHRDY	B10	Key	C10	MEMR	D10	DRQ0
A11	AEN	B11	SMEMW	C11	MEMW	D11	DACK5
A12	A19	B12	SMEMR	C12	D8	D12	DRQ5
A13	A18	B13	IOW	C13	D9	D13	DACK6
A14	A17	B14	IOR	C14	D10	D14	DRQ6
ZA15	A16	B15	DACK3	C15	D11	D15	DACK7
A16	A15	B16	DRQ3	C16	D12	D16	DRQ7
A17	A14	B17	DACK1	C17	D13	D17	VCC
A18	A13	B18	DRQ1	C18	D14	D18	MASTER
A19	A12	B19	REFRESH	C19	D15	D19	GND
A20	A11	B20	CLK	C20	KEY PIN	D20	GND
A21	A10	B21	IRQ7				
A22	A9	B22	IRQ6				
A23	A8	B23	IRQ5				
A24	A7	B24	IRQ4				
A25	A6	B25	IRQ3				
A26	A5	B26	DACK2				
A27	A4	B27	TC				
A28	A3	B28	BALE				
A29	A2	B29	VCC				
A30	A1	B30	OSC				
A31	A0	B31	GND				
A32	GND	B32	GND				

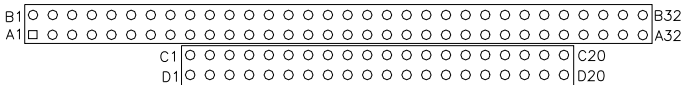

J2: Reset Switch



Pin #	Signal Name
1	Reset
2	Ground

J4: External Audio Connector

J4 is a 12-pin header that is used to connect to the optional audio cable card that integrates jacks for Line In, Line Out and Mic.

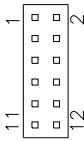

Signal Name	Pin #	Pin #	Signal Name
LINEOUT R	1	2	LINEOUT L
Ground	3	4	Ground
LINEIN R	5	6	LINEIN L
Ground	7	8	Ground
Mic-In	9	10	VREFOUT
Ground	11	12	Protect pin

J5: TFT Panel Connector

J5 is the pin header for TFT flat panel LCD displays.

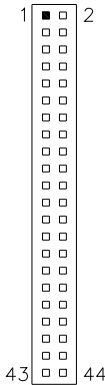

Signal Name	Pin #	Pin #	Signal Name
+12V	1	2	+12V
Ground	3	4	Ground
5V/3.3V	5	6	5V/3.3V
N.C.	7	8	Ground
R0	9	10	R1
R2	11	12	R3
R4	13	14	R5
R6	15	16	R7
G0	17	18	G1
G2	19	20	G3
G4	21	22	G5
G6	23	24	G7
B0	25	26	B1
B2	27	28	B3
B4	29	30	B5
B6	31	32	B7
Ground	33	34	Ground
SHFCLK	35	36	FLM(VSYNC)
DISPEN(A(MDE))	37	38	LP(HSYNC)
Ground	39	40	ENABKL
Ground	41	42	N.C.
ENA VDD	43	44	5V/3.3V

*Depends on JP2 setting (1-2 for 3.3V/default, 2-3 for 5V).

J6: LVDS Connectors

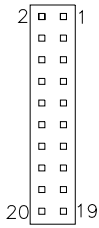

Signal Name	Pin #	Pin #	Signal Name
TX0-	2	1	TX0+
Ground	4	3	Ground
TX1-	6	5	TX1+
5V/3.3V	8	7	Ground
TX3-	10	9	TX3+
TX2-	12	11	TX2+
Ground	14	13	Ground
TXC-	16	15	TXC+
5V/3.3V	18	17	ENABKL
+12V	20	19	+12V

*Depends on JP2 setting (1-2 for 3.3V/default, 2-3 for 5V).

J7: IrDA Connector

J7 is used for an optional IrDA connector for wireless communication.

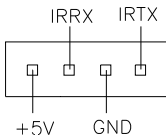

Pin #	Signal Name
1	+5V
2	Ir RX
3	Ground
4	Ir TX

J9, J15: USB Connectors

The J9, J15 USB pin header connectors support Four USB 2.0 ports via optional USB cables.

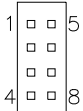

Signal Name	Pin	Pin	Signal Name
+5V	1	5	Ground
USB0-	2	6	USB1+
USB0+	3	7	USB1-
Ground	4	8	+5V

J10: PS/2 Keyboard and Mouse Connector

J10 is a 6-pin header for the external keyboard connector



Pin #	Signal Name
1	Keyboard Data
2	Keyboard Clock
3	Mouse Data
4	Mouse Clock
5	Ground
6	Vcc

J11: Parallel Port Connector

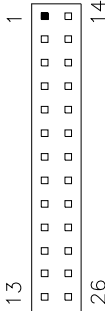

Signal Name	Pin #	Pin #	Signal Name
Line printer strobe	1	14	AutoFeed
PD0, parallel data 0	2	15	Error
PD1, parallel data 1	3	16	Initialize
PD2, parallel data 2	4	17	Select
PD3, parallel data 3	5	18	Ground
PD4, parallel data 4	6	19	Ground
PD5, parallel data 5	7	20	Ground
PD6, parallel data 6	8	21	Ground
PD7, parallel data 7	9	22	Ground
ACK, acknowledge	10	23	Ground
Busy	11	24	Ground
Paper empty	12	25	Ground
Select	13	N/A	Protect pin

J14: Power DC-In



Pin #	Signal Name
1	DC In (12V only)
2	Ground

J16: Digital 4-in 4-out Connector

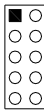

Signal Name	Pin	Pin	Signal Name
Ground	1	2	Vcc
Out3	3	4	Out1
Out2	5	6	Out0
IN3	7	8	IN1
IN2	9	10	IN0

IDE1: IDE Connector

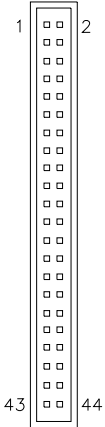

Signal Name	Pin #	Pin #	Signal Name
Reset IDE	1	2	Ground
Host data 7	3	4	Host data 8
Host data 6	5	6	Host data 9
Host data 5	7	8	Host data 10
Host data 4	9	10	Host data 11
Host data 3	11	12	Host data 12
Host data 2	13	14	Host data 13
Host data 1	15	16	Host data 14
Host data 0	17	18	Host data 15
Ground	19	20	Key
DRQ0	21	22	Ground
Host IOW	23	24	Ground
Host IOR	25	26	Ground
IOCHRDY	27	28	Host ALE
DACK0	29	30	Ground
IRQ14	31	32	No connect
Address 1	33	34	No connect
Address 0	35	36	Address 2
Chip select 0	37	38	Chip select 1
Activity	39	40	Ground
Vcc	41	42	Vcc
Ground	43	44	N.C.

SODIMM1: SO DIMM Socket

BIOS Setup

This chapter describes the different settings available in the Award BIOS that comes with the board. The topics covered in this chapter are as follows:

BIOS Introduction	20
BIOS Setup	20
Standard CMOS Setup	22
Advanced BIOS Features	25
Advanced Chipset Features	28
Integrated Peripherals	29
Power Management Setup	31
PNP/PCI Configurations	32
PC Health Status	33
Load Fail-Safe Defaults	34
Load Optimized Defaults	34
Set Password	34
Save & Exit Setup	34
Exit Without Saving	34

BIOS Introduction

The Award BIOS (Basic Input/Output System) installed in your computer system's ROM supports various processors. The BIOS provides critical low-level support for a standard device such as disk drives, serial ports and parallel ports. It also adds virus and password protection as well as special support for detailed fine-tuning of the chipset controlling the entire system.

BIOS Setup

The Award BIOS provides a Setup utility program for specifying the system configurations and settings. The BIOS ROM of the system stores the Setup utility. When you turn on the computer, the Award BIOS is immediately activated. Pressing the key immediately allows you to enter the Setup utility. If you are a little bit late pressing the key, POST (Power On Self Test) will continue with its test routines, thus preventing you from invoking the Setup. If you still wish to enter Setup, restart the system by pressing the "Reset" button or simultaneously pressing the <Ctrl>, <Alt> and <Delete> keys. You can also restart by turning the system Off and back On again. The following message will appear on the screen:

Press to Enter Setup

In general, you press the arrow keys to highlight items, <Enter> to select, the <PgUp> and <PgDn> keys to change entries, <F1> for help and <Esc> to quit.

When you enter the Setup utility, the Main Menu screen will appear on the screen. The Main Menu allows you to select from various setup functions and exit choices.

Phoenix - AwardBIOS CMOS Setup Utility	
Standard CMOS Features	Load Fail-Safe Defaults
Advanced BIOS Features	Load Optimized Defaults
Advanced Chipset Features	Set Supervisor
Integrated Peripherals	Set User Password
Power Management Setup	Save & Exit Setup
PnP/PCI Configurations	Exit Without Saving
PC Health Status	
ESC : Quit	↑ ↓ → ← : Select Item
F10 : Save & Exit Setup	
Time, Date, Hard Disk Type...	

The section below the setup items of the Main Menu displays the control keys for this menu. At the bottom of the Main Menu just below the control keys section, there is another section, which displays information on the currently highlighted item in the list.

Note: *If the system cannot boot after making and saving system changes with Setup, the Award BIOS supports an override to the CMOS settings that resets your system to its default.*

Warning: *It is strongly recommended that you avoid making any changes to the chipset defaults. These defaults have been carefully chosen by both Award and your system manufacturer to provide the absolute maximum performance and reliability. Changing the defaults could cause the system to become unstable and crash in some cases.*

Standard CMOS Setup

“Standard CMOS Setup” choice allows you to record some basic hardware configurations in your computer system and set the system clock and error handling. If the motherboard is already installed in a working system, you will not need to select this option. You will need to run the Standard CMOS option, however, if you change your system hardware configurations, the onboard battery fails, or the configuration stored in the CMOS memory was lost or damaged.

Phoenix - AwardBIOS CMOS Setup Utility
Standard CMOS Features

		Item Help
Date (mm:dd:yy)	Fri, Jun 30, 2006	Menu Level > Change the day, month, Year and century
Time (hh:mm:ss)	00 : 00 : 00	
IDE Primary Master	None	
IDE Primary Slave	None	
Drive A	1.44"	
Drive B	None	
Video	EGA/VGA	
Halt On	All, But keyboard	
Base Memory	640K	
Extended Memory	514816K	
Total Memory	515584K	

At the bottom of the menu are the control keys for use on this menu. If you need any help in each item field, you can press the <F1> key. It will display the relevant information to help you. The memory display at the lower right-hand side of the menu is read-only. It will adjust automatically according to the memory changed. The following describes each item of this menu.

Date

The date format is:

Day : Sun to Sat
Month : 1 to 12
Date : 1 to 31
Year : 1999 to 2099

To set the date, highlight the “Date” field and use the PageUp/PageDown or +/- keys to set the current time.

Time

The time format is: **Hour : 00 to 23**
Minute : 00 to 59
Second : 00 to 59

To set the time, highlight the “Time” field and use the <PgUp>/<PgDn> or +/- keys to set the current time.

IDE Primary HDDs / IDE Secondary HDDs

The onboard PCI IDE connectors provide Primary and Secondary channels for connecting up to four IDE hard disks or other IDE devices. Each channel can support up to two hard disks; the first is the “Master” and the second is the “Slave”.

Press <Enter> to configure the hard disk. The selections include Auto, Manual, and None. Select ‘Manual’ to define the drive information manually. You will be asked to enter the following items.

CYLS : Number of cylinders
HEAD : Number of read/write heads
PRECOMP : Write precompensation
LANDING ZONE : Landing zone
SECTOR : Number of sectors

The Access Mode selections are as follows:

CHS (HD < 528MB)
LBA (HD > 528MB and supports
 Logical Block Addressing)
Large (for MS-DOS only)
Auto

Remarks: The main board supports two serial ATA ports and are represented in this setting as IDE Channel 2 / 3 Master.

Drive A / Drive B

These fields identify the types of floppy disk drive A or drive B that has been installed in the computer. The available specifications are:

360KB	1.2MB	720KB	1.44MB	2.88MB
5.25 in.	5.25 in.	3.5 in.	3.5 in.	3.5 in.

Video

This field selects the type of video display card installed in your system.

You can choose the following video display cards:

EGA/VGA	For EGA, VGA, SEGA, SVGA or PGA monitor adapters. (default)
CGA 40	Power up in 40 column mode.
CGA 80	Power up in 80 column mode.
MONO	For Hercules or MDA adapters.

Halt On

This field determines whether or not the system will halt if an error is detected during power up.

No errors	The system boot will not be halted for any error that may be detected.
All errors	Whenever the BIOS detects a non-fatal error, the system will stop and you will be prompted.
All, But Keyboard	The system boot will not be halted for a keyboard error; it will stop for all other errors
All, But Diskette	The system boot will not be halted for a disk error; it will stop for all other errors.
All, But Disk/Key	The system boot will not be halted for a keyboard or disk error; it will stop for all others.

Advanced BIOS Features

This section allows you to configure and improve your system and allows you to set up some system features according to your preference.

Phoenix - AwardBIOS CMOS Setup Utility
Advanced BIOS Features

		ITEM HELP
Virus Warning	Disabled	Menu Level >
CPU Internal Cache	Enabled	
First Boot Device	Floppy	
Second Boot Device	HDD-0	
Third Boot Device	CDROM	
Boot Other Device	Enabled	
Swap Floppy Drive	Disabled	
Boot Up Floppy Seek	Disabled	
Boot Up NumLock Status	On	
Gate A20 Option	Fast	
Typeomatic Rate Setting	Disabled	
Typeomatic Rate (Chars/Sec)	6	
Typeomatic Delay (Msec)	250	
Security Option	Setup	
OS Select For DRAM>64MB	Non-OS2	
Small Logo (EPA) Show	Disabled	

Virus Warning

If this option is enabled, an alarm message will be displayed when trying to write on the boot sector or on the partition table on the disk, which is typical of the virus.

CPU Internal Cache

Cache memory is additional memory that is much faster than conventional DRAM (system memory). CPUs from 486-type on up contain internal cache memory, and most, but not all, modern PCs have additional (external) cache memory. When the CPU requests data, the system transfers the requested data from the main DRAM into cache memory, for even faster access by the CPU.

First/Second/Third Boot Device

These fields determine the drive that the system searches first for an operating system. The options available include *Floppy*, *LS120*, *HDD-0*, *SCSI*, *CDROM*, *HDD-1*, *HDD-2*, *HDD-3*, *ZIP100*, *USB-FDD*, *LAN*, *USB-CDROM*, *USB-HDD* and *Disable*.

Boot Other Device

These fields allow the system to search for an OS from other devices other than the ones selected in the First/Second/Third Boot Device.

Swap Floppy Drive

This item allows you to determine whether or not to enable Swap Floppy Drive. When enabled, the BIOS swaps floppy drive assignments so that Drive A becomes Drive B, and Drive B becomes Drive A. By default, this field is set to *Disabled*.

Boot Up Floppy Seek

This feature controls whether the BIOS checks for a floppy drive while booting up. If it cannot detect one (either due to improper configuration or its absence), it will flash an error message.

Boot Up NumLock Status

This allows you to activate the NumLock function after you power up the system.

Gate A20 Option

This field allows you to select how Gate A20 is worked. Gate A20 is a device used to address memory above 1 MB.

Typematic Rate Setting

When disabled, continually holding down a key on your keyboard will generate only one instance. When enabled, you can set the two typematic controls listed next. By default, this field is set to *Disabled*.

Typematic Rate (Chars/Sec)

When the typematic rate is enabled, the system registers repeated keystrokes speeds. Settings are from 6 to 30 characters per second.

Typematic Delay (Msec)

When the typematic rate is enabled, this item allows you to set the time interval for displaying the first and second characters. By default, this item is set to *250msec*.

Security Option

This field allows you to limit access to the System and Setup. The default value is *Setup*. When you select *System*, the system prompts for the User Password every time you boot up. When you select *Setup*, the system always boots up and prompts for the Supervisor Password only when the Setup utility is called up.

OS Select for DRAM > 64MB

This option allows the system to access greater than 64MB of DRAM memory when used with OS/2 that depends on certain BIOS calls to access memory. The default setting is *Non-OS/2*.

Small Logo (EPA) Show

The EPA logo appears at the right side of the monitor screen when the system is boot up.

Advanced Chipset Features

This Setup menu controls the configuration of the chipset.

Phoenix - AwardBIOS CMOS Setup Utility
Advanced Chipset Features

		ITEM HELP
CPU Frequency	Auto	Menu Level >
Memory Frequency	Auto	
CAS Latency	Auto	
Video Memory Size	8M	
Output Display	CRT	
Flat Panel Configuration	Press Enter	
Onboard Audio	Enabled	
Overcurrent Reporting	Disabled	
Port 4 Assignment	Host	
Memory Hole at 15M-16M	Disabled	

CPU Frequency

This options for this field are *Auto*, *433MHz* and *500MHz*.

Memory Frequency

This default setting for this field is *Auto*. Other options are *100MHz*, *133MHz*, *166MHz*, and *200MHz*.

CAS Latency Time

You can configure CAS latency time in HCLKs as *1.5*, *2*, *2.5*, *3* or *3.5*. The system board designer should set the values in this field, depending on the DRAM installed. Do not change the values in this field unless you change specifications of the installed DRAM or the installed CPU.

Video Memory Size

The default setting for this field is *8M*. The options are from *8M* to *254M*.

Flat Panel Configuration

This options for this field are *Flat Panel*, *CRT* and *Panel & CRT*. For flat panel, configuration settings include Flat Panel Type, Resolution (320x240 up to 1600x1200), Data Bus Type, Refresh Rate (60~100Hz), HSYNC Polarity, VSYNC Polarity, SHFCLK Active Period and LP Active Period.

Memory Hole At 15M-16M

In order to improve performance, certain space in memory can be reserved for ISA cards. This memory must be mapped into the memory space below 16 MB. The choices are *Enabled* and *Disabled*.

Integrated Peripherals

This section sets configurations for your hard disk and other integrated peripherals. The first screen shows three main items for user to select. Once an item selected, a submenu appears. Details follow.

Phoenix - AwardBIOS CMOS Setup Utility
Integrated Peripherals

		ITEM HELP
Master Drive PIO Mode	Auto	Menu Level >
Slave Drive PIO Mode	Auto	
IDE Primary Master UDMA	Disabled	
IDE Primary Slave UDMA	Disabled	
IDE DMA transfer access	Enabled	
IT888 ISA Decode IO	[Press Enter]	
IT888 ISA Decode Memory	[Press Enter]	
IT888 DMA	[Press Enter]	
IDE HDD Block Mode	Enabled	
Onboard LAN Boot ROM	Disabled	
Onboard FDC Controller	Disabled	
Onboard Serial Port 1	3F8/IRQ4	
Onboard Serial Port 2	2F8/IRQ3	
UART Mode Select	Normal	
Onboard Parallel Port	387/IRQ7	
Parallel Port Mode	SPP	
EPP Mode Select	EPP1.7	
ECP Mode Use DMA	3	
**** 2 nd SuperIO Device ****		
Onboard Serial Port 3	3E8h	
Serial Port Ise IRQ	IRQ11	
Onboard Serial Port 4	Disabled	
Serial Port Ise IRQ	IRQ10	

IDE Primary/Secondary Master/Slave PIO

These fields allow your system hard disk controller to work faster. Rather than have the BIOS issue a series of commands that transfer to or from the disk drive, PIO (Programmed Input/Output) allows the BIOS to communicate with the controller and CPU directly.

The system supports five modes, numbered from 0 (default) to 4, which primarily differ in timing. When Auto is selected, the BIOS will select the best available mode.

IDE Primary/Secondary Master/Slave UDMA

These fields allow your system to improve disk I/O throughput to 33Mb/sec with the Ultra DMA/33 feature. The options are *Auto* and *Disabled*.

IDE HDD Block Mode

This field allows your hard disk controller to use the fast block mode to transfer data to and from your hard disk drive.

Onboard LAN Boot ROM

This feature allows users to enable or disable the onboard LAN boot ROM. The default setting is *Disabled*

Onboard FDC Controller

Select *Enabled* if your system has a floppy disk controller (FDC) installed on the motherboard and you wish to use it. If you install an add-in FDC or the system has no floppy drive, select *Disabled* in this field. This option allows you to select the onboard FDD port.

Onboard Serial/Parallel Port

These fields allow you to select the onboard serial and parallel ports and their addresses. The default values for these ports are:

Serial Port 1	3F8/IRQ4
Serial Port 2	2F8/IRQ3
Parallel Port	378H/IRQ7

UART Mode Select

This field determines the UART 2 mode in your computer. The default value is *Normal*. Other options include *IrDA* and *ASKIR*.

Parallel Port Mode

This field allows you to determine parallel port mode function.

SPP	Standard Printer Port
EPP	Enhanced Parallel Port
ECP	Extended Capabilities Port

Power Management Setup

The Power Management Setup allows you to save energy of your system effectively.

Phoenix - AwardBIOS CMOS Setup Utility
Power Management Setup

ACPI Function	Disabled	ITEM HELP
Power Management	APM	
** PM Timers **		Menu Level >
Standby Mode	Disabled	
Suspend Mode	Disabled	
Modem Use IRQ	N/A	
Time (hh:mm:ss) Alarm	0	
IRQ Wakeup Events	Press Enter	

Power Management

The options for the power management setting are *Disabled*, *Legacy*, *ACPI* and *APM*.

Suspend Mode

When enabled, and after the set time of system inactivity, all devices except the CPU will be shut off.

PNP/PCI Configurations

This option configures the PCI bus system. All PCI bus systems on the system use INT#, thus all installed PCI cards must be set to this value.

Phoenix - AwardBIOS CMOS Setup Utility
PnP/PCI Configurations

PNP OS Installed	No	ITEM HELP
Init Display First	PCI Slot	Menu Level
Reset Configuration Data	Disabled	
Resources Controlled By	Auto (ESCD)	Default is Disabled. Select Enabled to reset Extended System Configuration Data ESCD) when you exit Setup if you have installed a new add-on and the system reconfiguration has caused such a serious conflict that the OS cannot boot.
IRQ Resources	Press Enter	
Memory Resources	Press Enter	
PCI/VGA Palette Snoop	Disabled	

PNP OS Installed

If your OS supports Plug & Play (PnP), select **Yes** so that it can take over the management of device resources. If you are using a non-PnP-aware OS or not all of the operating systems you are using support PnP, select **No** to let the BIOS handle it instead.

Init Display First

This field refers to the primary video or primary video adapter. The default setting is *PCI Slot*.

Reset Configuration Data

This field allows you to determine whether to reset the configuration data or not. The default value is *Disabled*.

Resources Controlled by

This PnP BIOS can configure all of the boot and compatible devices automatically with the use of a use a PnP OS system such as Windows 95.

PCI/VGA Palette Snoop

Some non-standard VGA display cards may not show colors properly. This field allows you to set whether or not MPEG ISA/VESA VGA cards can work with PCI/VGA. When this field is enabled, a PCI/VGA can work with an MPEG ISA/VESA VGA card. When this field is disabled, a PCI/VGA cannot work with an MPEG ISA/VESA card.

PC Health Status

This section shows the parameters in determining the PC Health Status. These parameters include temperatures, fan speeds and voltages.

Phoenix - AwardBIOS CMOS Setup Utility
PC Health Status

		ITEM HELP
Current System Temp.	45°C/113°F	Menu Level >
Current CPU Temp	30°C/86°F	
Vcore(V)	1.18 V	
Vmem	2.57V	
Vcc3(V)	3.39V	
+5V	5.13 V	
VBAT	3.21 V	

Temperatures/Voltages

These fields are the parameters of the hardware monitoring function feature of the motherboard. The values are read-only values as monitored by the system and show the PC health status.

Load Fail-Safe Defaults

This option allows you to load the troubleshooting default values permanently stored in the BIOS ROM. These default settings are non-optimal and disable all high-performance features.

Load Optimized Defaults

This option allows you to load the default values to your system configuration. These default settings are optimal and enable all high performance features.

Set Supervisor/User Password

These two options set the system password. Supervisor Password sets a password that will be used to protect the system and Setup utility. User Password sets a password that will be used exclusively on the system. To specify a password, highlight the type you want and press <Enter>. The Enter Password: message prompts on the screen. Type the password, up to eight characters in length, and press <Enter>. The system confirms your password by asking you to type it again. After setting a password, the screen automatically returns to the main screen.

To disable a password, just press the <Enter> key when you are prompted to enter the password. A message will confirm the password to be disabled. Once the password is disabled, the system will boot and you can enter Setup freely.

Save & Exit Setup

This option allows you to determine whether or not to accept the modifications. If you type “Y”, you will quit the setup utility and save all changes into the CMOS memory. If you type “N”, you will return to Setup utility.

Exit Without Saving

Select this option to exit the Setup utility without saving the changes you have made in this session. Typing “Y” will quit the Setup utility without saving the modifications. Typing “N” will return you to Setup utility.

Drivers Installation

This section describes the installation procedures for software and drivers under the Windows 2000 and Windows XP. The software and drivers are included with the motherboard. If you find the items missing, please contact the vendor where you made the purchase. The contents of this section include the following:

Entertainment Encryption/Decryption Controller Driver	36
VGA Drivers Installation	38
Audio Driver Installation	41
PCI Bridge Driver Installation	44

Entertainment Encryption/Decryption Controller Driver

1. In the Windows operating system, go to the Device Manager.
2. As shown below, click the **Entertainment Encryption/Decryption Controller** under **Other devices**.

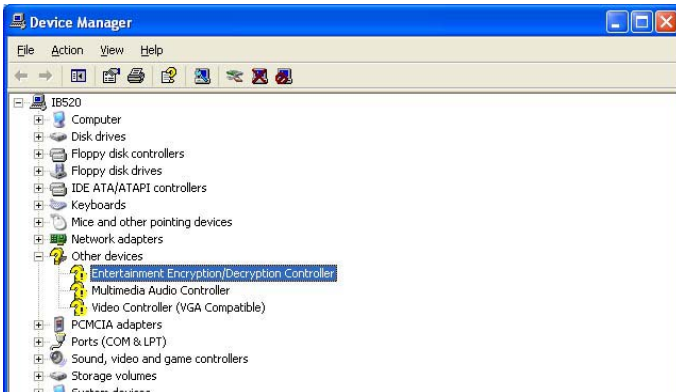

3. In the following window, click the **Driver** tab and click **OK** to continue.

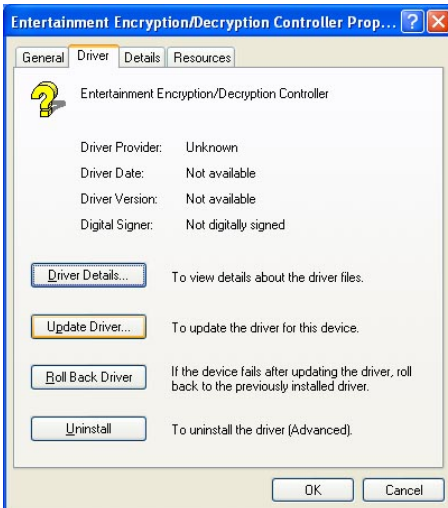

4. In the Hardware Update Wizard, select **No, not this time** and click **Next** to continue. Then select **Install from a list of specific location (Advanced)**. Click **Browse** to find the driver's path in the CD provided - \AMD\AES. Then, click **Next** to start the drivers installation. Then click **Finish** after the wizard has finished installing the software for **Geode LX AES Crypto Driver**.

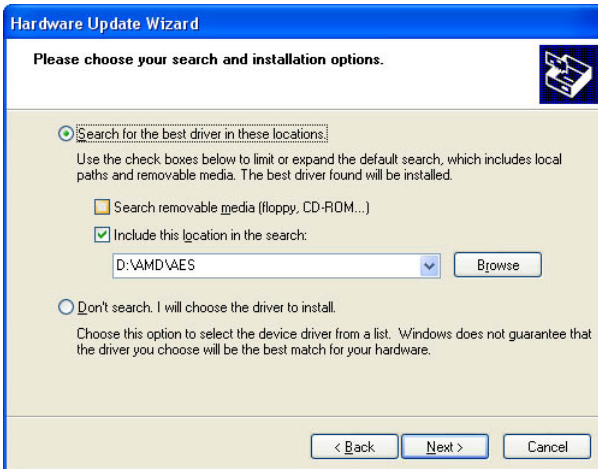

VGA Drivers Installation

1. In the Windows operating system, go to the Device Manager.
2. As shown below, click the **Video Controller (VGA Compatible)** under **Other devices**.

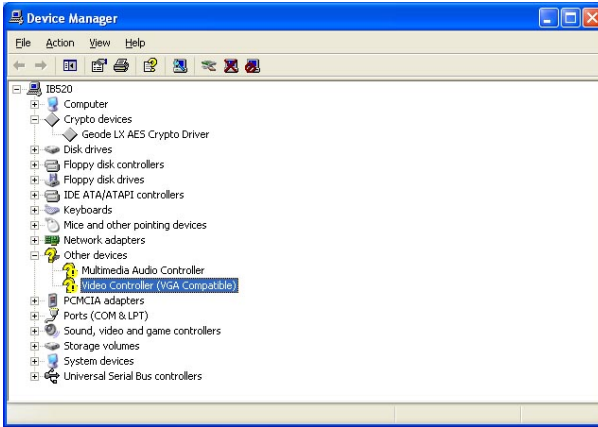

3. In the following window, click the **Driver** tab and click **OK** to continue.

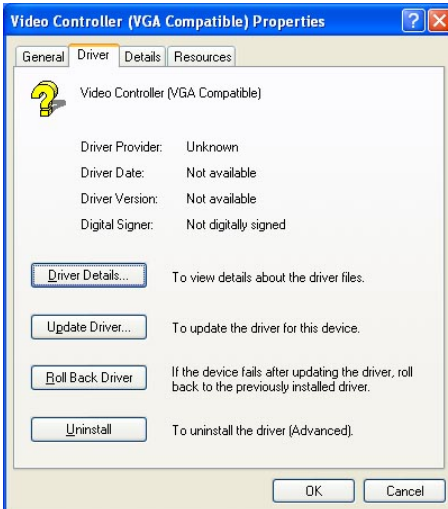

4. In the Hardware Update Wizard, select **No, not this time** and click **Next** to continue. Then select **Install from a list of specific location (Advanced)**.

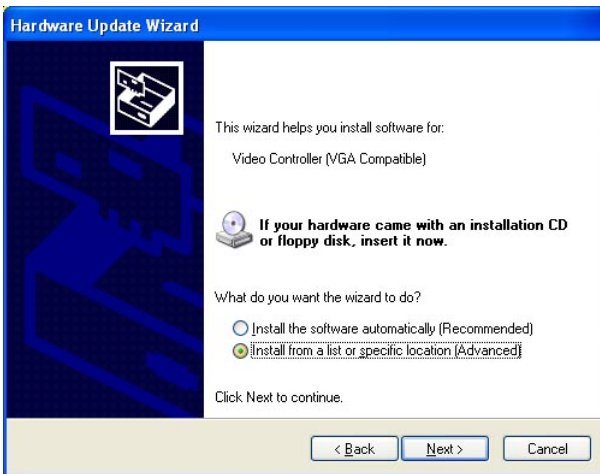

5. In the next screen, click **Search for the best driver in these** locations. Check **Include this location in the search**. Click **Browse** to find the driver's path in the CD provided or enter the path directly - **\AMD\Vga**. Then, click **Next** to start the drivers installation. Then click **Finish** after the wizard has finished installing the software for *Advanced Micro Devices Win XP Graphics Driver*.

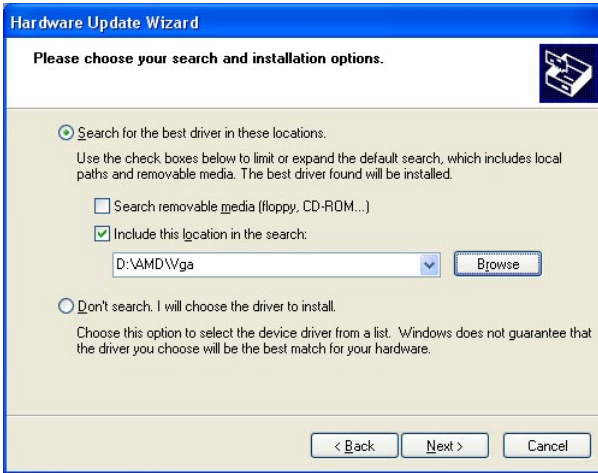

Audio Driver Installation

1. In the Windows operating system, go to the Device Manager.
2. As shown below, click the **Multimedia Audio Controller** under **Other devices**.

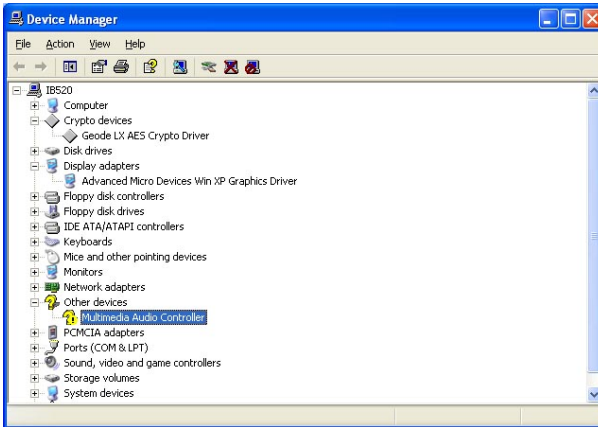

3. In the following window, click the **Driver** tab and click **OK** to continue.

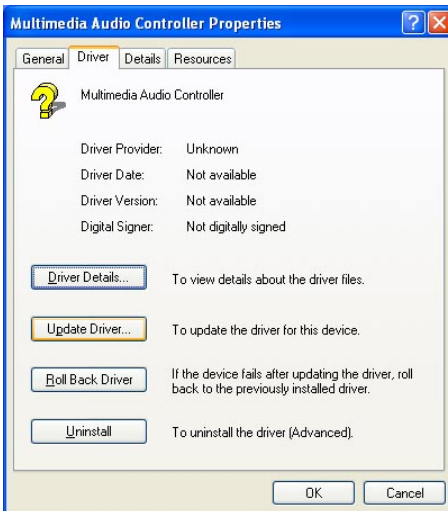

4. In the Hardware Update Wizard, select **No, not this time** and click **Next** to continue. Then select **Install from a list of specific location (Advanced)**.

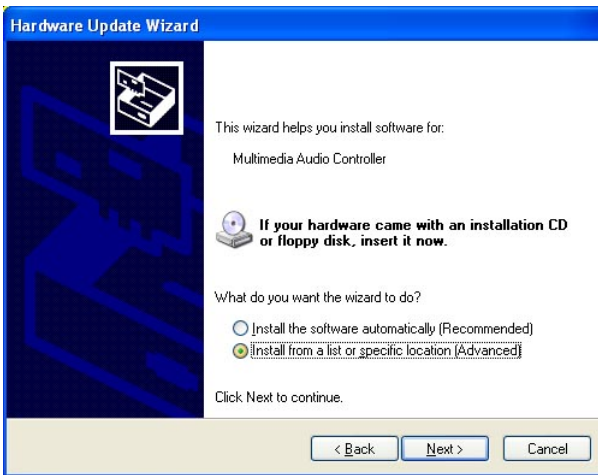

5. In the next screen, click **Search for the best driver in these** locations. Check **Include this location in the search**. Click **Browse** to find the driver's path in the CD provided or enter the path directly - **\\AMD\\Audio\\XPe**. Then, click **Next** to start the drivers installation. Then click **Finish** after the wizard has finished installing the software for **GeodeLX Audio Driver (WDM)**.

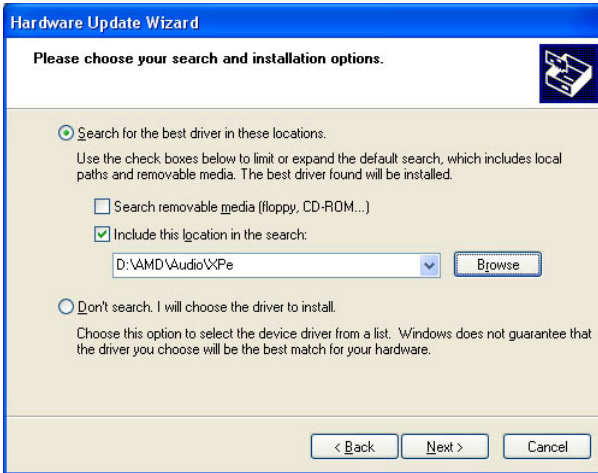

PCI Bridge Driver Installation

1. In the Windows operating system, go to the Device Manager.
2. As shown below, click **Other devices**, then **Other PCI Bridge Device**.

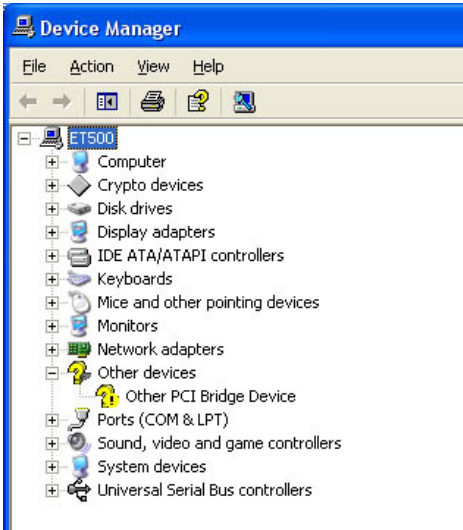

3. In the following window, click the **Driver** tab and click **Update Driver** to continue.

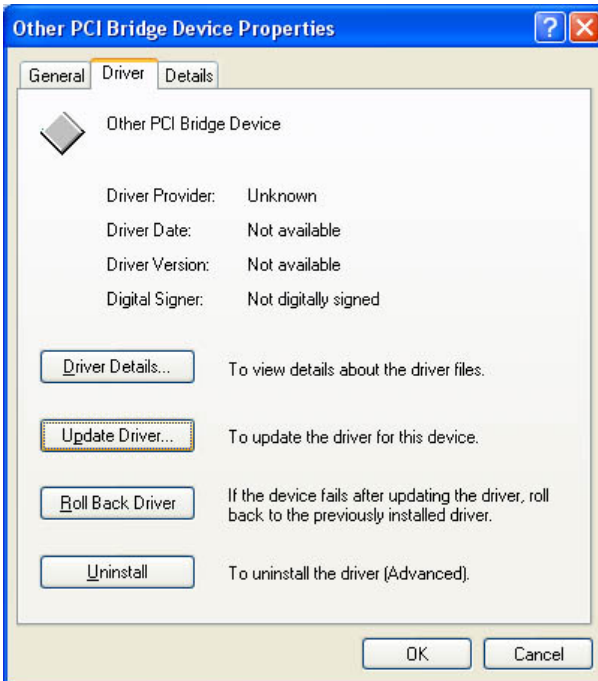

4. In the Hardware Update Wizard, select **No, not this time** and click **Next** to continue. Then select **Install from a list of specific location (Advanced)**.

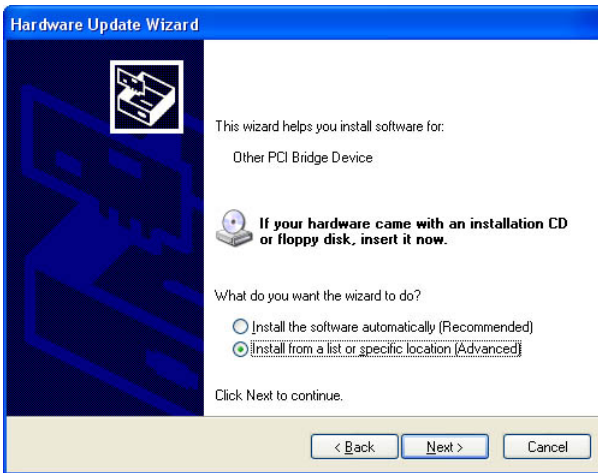

5. In the next screen, check **Include this location in the search**. Click **Browse** to find the driver's path in the CD provided or enter the path directly - `\\AMD\ITE8888`. Then, click **Next** to start the drivers installation.

Appendix

A. I/O Port Address Map

Each peripheral device in the system is assigned a set of I/O port addresses which also becomes the identity of the device. The following table lists the I/O port addresses used.

Address	Device Description
000h - 01Fh	DMA Controller #1
020h - 03Fh	Interrupt Controller #1
040h - 05Fh	Timer
060h	Keyboard Controller (1)
0601h	Control Port
064h	Real Time Clock
070h - 07Fh	Keyboard Controller (2)
080h - 09Fh	DMA Page Register
0A0h - 0BFh	Interrupt Controller #2
0C0h - 0DFh	DMA Controller #2
0F0h - 0FFh	Coprocessor
01F0h - 01F7h 03F6h	IDE (Primary)
02F8h - 02FFh	Serial Port #2(COM2)
0378h - 037Ah	Parallel Port #1(LPT1)
03C0h - 03DFh	Reserved for VGA
03F0h - 03F5h 03F7h	FDD Controller
03F8h - 3FFh	Serial Port #1(COM1)

B. Interrupt Request Lines (IRQ)

Peripheral devices use interrupt request lines to notify CPU for the service required. The following table shows the IRQ used by the devices on board.

Level	Function
IRQ0	System Timer Output
IRQ1	Keyboard
IRQ2	PIC2 (IRQ8-15)
IRQ3	Serial Port #2
IRQ4	Serial Port #1
IRQ5	For PCI
IRQ6	Floppy Disk Controller
IRQ7	Parallel Port #1
IRQ8	Real Time Clock
IRQ9	For PCI
IRQ10	For PCI
IRQ11	For PCI
IRQ12	PS/2 Mouse
IRQ13	Coprocessor
IRQ14	Primary IDE

C. Watchdog Timer Configuration

The WDT is used to generate a variety of output signals after a user programmable count. The WDT is suitable for use in the prevention of system lock-up, such as when software becomes trapped in a deadlock. Under these sort of circumstances, the timer will count to zero and the selected outputs will be driven. Under normal circumstance, the user will restart the WDT at regular intervals before the timer counts to zero.

SAMPLE CODE:

This code and information is provided "as is" without warranty of any kind, either expressed or implied, including but not limited to the implied warranties of merchantability and/or fitness for a particular purpose.

```

:[]=====
; Name      : Enable_And_Set_Watchdog
; IN       : AL - 1sec ~ 255sec
; OUT      : None
:[]=====
Enable_And_Set_Watchdog Proc Near
    push ax                ;save time interval
    call Unlock_Chip

    mov cl, 2Bh
    call Read_Reg
    and al, NOT 10h
    call Write_Reg        ;set GP24 as WDTO

    mov cl, 07h
    mov al, 08h
    call Write_Reg        ;switch to LD8
    mov cl, 0F5h
    call Read_Reg
    and al, NOT 08h
    call Write_Reg        ;set count mode as second

    pop ax
    mov cl, 0F6h
    call Write_Reg        ;set watchdog timer

    mov al, 01h
    mov cl, 30h
    call Write_Reg        ;watchdog enabled

```

```

        call Lock_Chip
        ret
Enable_And_Set_Watchdog   Endp

```

```

;[]=====
;Name   : Disable_Watchdog
;IN  : None
;OUT   : None
;[]=====

```

```

Disable_Watchdog  Proc Near
        call Unlock_Chip

        mov cl, 07h
        mov al, 08h
        call Write_Reg      ;switch to LD8

        xor al, al
        mov cl, 0F6h
        call Write_Reg      ;clear watchdog timer

        xor al, al
        mov cl, 30h
        call Write_Reg      ;watchdog disabled

        call Lock_Chip
        ret
Disable_Watchdog  Endp

```

```

;[]=====
;Name   : Unlock_Chip
;IN  : None
;OUT   : None
;[]=====

```

```

Unlock_Chip  Proc Near
        mov dx, 4Eh
        mov al, 87h
        out dx, al
        out dx, al
        ret
Unlock_Chip  Endp

```

```

;[]=====
;Name   : Lock_Chip
;IN  : None
;OUT   : None

```

```

;[]=====
Unlock_Chip Proc Near
    mov dx,4Eh
    mov al,0Aah

    out dx,al
    ret
Unlock_Chip Endp
;[]=====
; Name : Write_Reg
; IN : CL - register index
; AL - Value to write
; OUT : None
;[]=====
Write_RegProc Near
    push ax
    mov dx,4Eh
    mov al,cl
    out dx,al
    pop ax
    inc dx
    out dx,al
    ret
Write_RegEndp
;[]=====
; Name : Read_Reg
; IN : CL - register index
; OUT : AL - Value to read
;[]=====
Read_Reg Proc Near
    mov al,cl
    mov dx,4Eh
    out dx,al
    inc dx
    in al,dx
    ret
Read_Reg Endp
;[]=====
```

This page is intentionally left blank.