

# ET910

Intel® Core™ Duo/Solo 945GM  
ETX CPU Module

## USER'S MANUAL

Version 1.0

---

## **Acknowledgments**

Award is a registered trademark of Award Software International, Inc.

PS/2 is a trademark of International Business Machines Corporation.

Intel and Celeron are registered trademarks of Intel Corporation.

Microsoft Windows is a registered trademark of Microsoft Corporation.

Winbond is a registered trademark of Winbond Electronics Corporation.

All other product names or trademarks are properties of their respective owners.

---

# Table of Contents

<b>Introduction .....</b>	<b>1</b>
Product Description.....	1
Checklist.....	2
Specifications .....	3
Dimensions.....	4
Connector Locations on ET910.....	5
Installing the CPU .....	6
Installing the Memory .....	8
Connector Pin Assignments .....	9
<b>BIOS Setup.....</b>	<b>13</b>
<b>Drivers Installation .....</b>	<b>33</b>
Intel Chipset Software Installation Utility.....	34
VGA Drivers Installation .....	36
AC97 Codec Audio Driver Installation (IP100 only) .....	38
Intel PRO LAN Drivers Installation.....	40

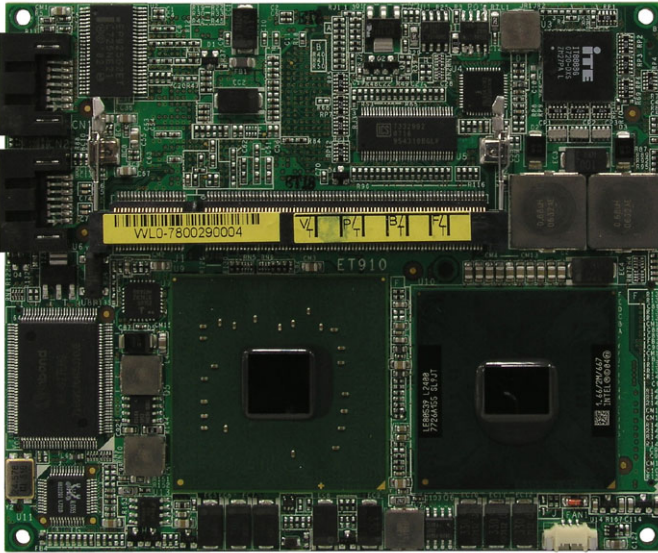

The ET910 945GM ETX CPU Module

# Introduction

## Product Description

---

---

ET910 is an ETX CPU module based on the Intel® 945GM chipset. The Intel® 945GM chipset graphics memory controller hub (GMCH-M) is a component of Intel® Centrino mobile technology. In addition, the Intel® 945GM chipset provides integrated graphics (350 MHz) capabilities and power saving features.

Below are the main features of the ET910 ETX CPU module.

- Support Intel® Core™2 Duo/ Core™ Duo Processor
- DDR2 SO-DIMM 533/667 for advanced system performance
- Integrated Intel® Graphic Media Accelerator 950
- Integrated ICH7M 10/100 BaseT Ethernet
- SATA x2, USB 2.0 x4, COM x2, PCI x4

System memory is provided by a SO-DIMM socket that supports up to 2GB of DDR memory. The on board Award BIOS facilitates easy system configuration and peripheral setup. Other features include two SATA ports, two RS232 serial ports, one parallel port, four USB ports support, watchdog timer and PCI to ISA bridge. Board size is 95mm by 114mm.

The ET910 has four board-to-board high-density interface connectors for I/O signals that plug onto baseboards specific to customer's applications. ETX embedded solutions provide fast time-to-market through the interchangeability and scalability of both the ETX module and the baseboard.

ETX stands for Embedded Technology extended, a technology or form factor that offers flexible time-to-market solution, enabling product development time to shrink from four months to just four weeks. It also features low power consumption and low heat emission, eliminating the need for a CPU fan.

## Checklist

---

Your ET910 package should include the items listed below.

- The ET910 CPU Module
- This User's Manual
- 1 CD containing the following:
  - Chipset Drivers
  - Flash Memory Utility
- Serial ATA cable

## Specifications

<b>Form Factor</b>	ETX 3.0 CPU module
<b>CPU Type</b>	Intel Core Duo / Core 2 Duo processor
<b>CPU Voltage</b>	0.700V ~ 1.5V
<b>System Speed</b>	1.66GHz or above
<b>CPU FSB</b>	533MHz/667MHz FSB
<b>Cache</b>	2MB
<b>Green /APM</b>	APM1.2
<b>CPU Socket</b>	BGA CPU on board or mPGA 478MT socket
<b>Chipset</b>	Intel 945GM Chipset GMCH: 82945GM 1466-pin FCBGA ICH7M: 82801GBM 652-pin mBGA FWH
<b>BIOS</b>	Award BIOS, support ACPI function
<b>Memory</b>	DDRII 667/533 SO-DIMM x1 (w/o ECC function), Max. 2GB
<b>VGA</b>	945GM built-in, supports dual display with CRT & LVDS
<b>LVDS</b>	945GM built-in 18+18 bits single or dual channel LVDS
<b>LAN</b>	ICH7M built-in 10/100BT MAC + Intel EP82562ET PHY
<b>USB</b>	ICH7M built-in USB 2.0 host controller, supports 4 ports
<b>Serial ATA Ports</b>	ICH7M built-in SATA controller, supports 2 ports
<b>Parallel IDE</b>	ICH7M built-in one channel Ultra DMA 33/66/100 for HDDs, CF or DOM on carrier board
<b>2<sup>nd</sup> IDE</b>	PCI-e to IDE x1 for 2nd IDE (reserved)
<b>LPC I/O</b>	Winbond W83627EHF: COM1, COM2 (RS232), IrDA x1 & Hardware monitor (3 thermal inputs, 3 voltage monitor inputs & 1 Fan Header)
<b>Audio</b>	ICH7M built-in Audio controller + ALC655 AC97 codec for 5.1 channels audio (line-out, line-in & mic.)
<b>RTC</b>	ICH7M built-in RTC with on board battery
<b>PCI to ISA</b>	ITE IT8888G x1 (salve ISA only)
<b>Watch-Dog Timer</b>	Yes (256 segments, 0, 1, 2...255. sec/min)
<b>Connector to Carrier Board</b>	Hirose FX8-100P-SV ETX connector x4 for PCI bus, USB, audio, VGA/CRT, LVDS, LAN, COM ports, parallel port, IDE, PS/2 Keyboard/Mouse & ISA bus
<b>Power</b>	+5V, 5VSB & 3V for RTC
<b>RoHS Compliant</b>	Yes
<b>Board Size</b>	95mm x 114mm

# Dimensions

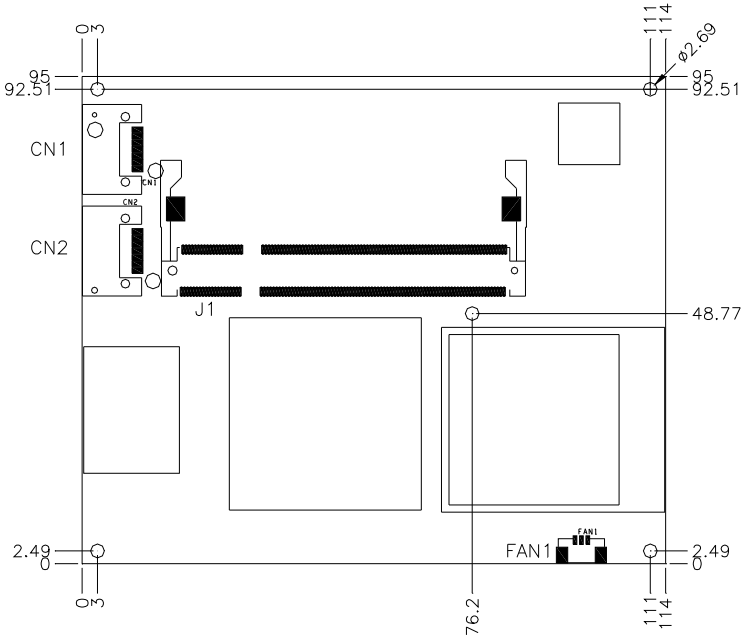

## Connector Locations on ET910

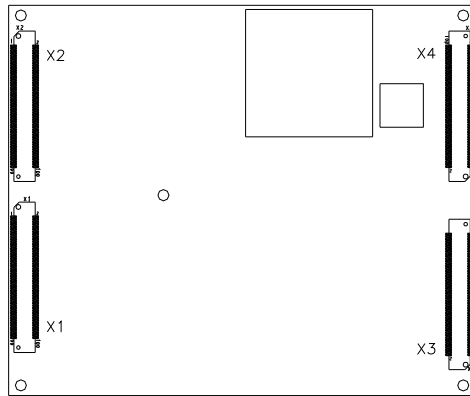
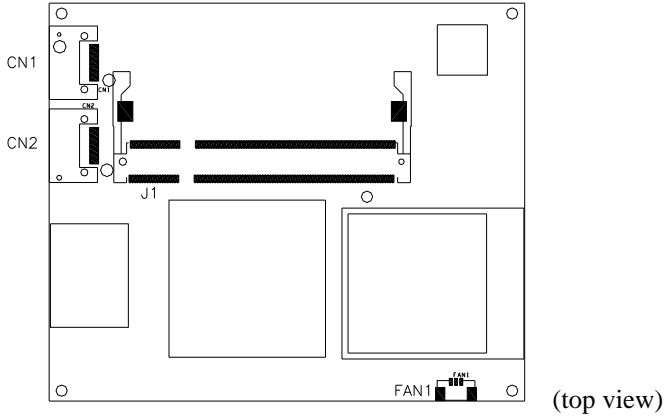

## Installing the CPU

---

The ET910 module supports a Socket 478MT (Napa) processor socket for Intel® Core™ 2 Duo , Intel® Core™ Duo and Intel® Core™ Solo mobile processors.

The processor socket comes with a screw to secure the processor. As shown in the left picture below, loosen the screw first before inserting the processor. Place the processor into the socket by making sure the notch on the corner of the CPU corresponds with the notch on the inside of the socket. Once the processor has slide into the socket, fasten the screw. Refer to the figures below.

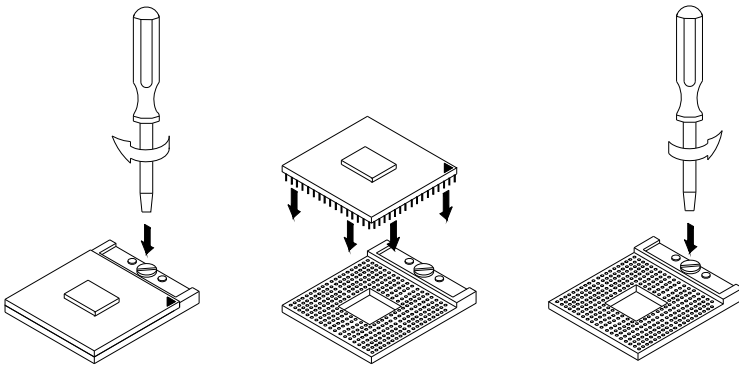

**NOTE:** Ensure that the CPU heat sink and the CPU top surface are in total contact to avoid CPU overheating problem that would cause your system to hang or be unstable.

Before installing the heatsink, the four (4) pieces of protective sheaths on the thermal pads should be removed first. Please refer to the following pictures:

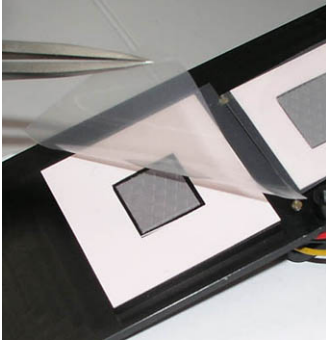

Chipset thermal pad 1

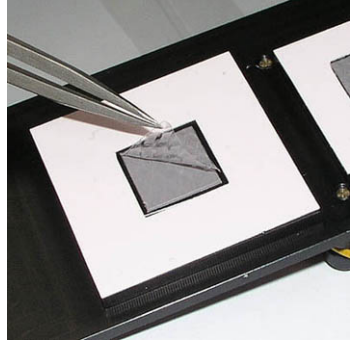

Chipset thermal pad 2

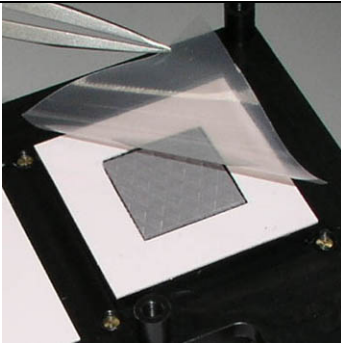

CPU thermal pad 1

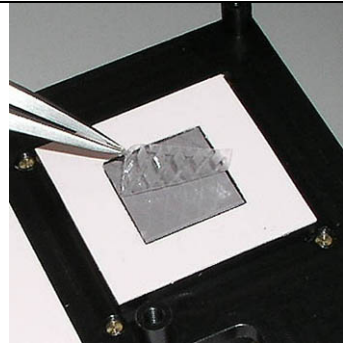

CPU thermal pad 2

## Installing the Memory

---

The ET910 supports one SODIMM DDR memory socket for a maximum total memory of 2GB. The memory module capacities supported are 128MB, 256MB, 512MB, 1GB and 2GB.

### Installing and Removing Memory Modules

To install the DDR modules, locate the memory slot on the board and perform the following steps:

1. Hold the DDR module so that the keys of the DDR module align with those on the memory slot. Insert the module into the socket at a slight angle (approximately 30 degrees). Note that the socket and module are both keyed, which means that the module can be installed only in one direction.
2. To seat the memory module into the socket, apply firm and even pressure to each end of the module until you feel it slip down into the socket.
3. With the module properly seated in the socket, rotate the module downward. Continue pressing downward until the clips at each end lock into position.
4. To remove the DDR module, press the clips with both hands.

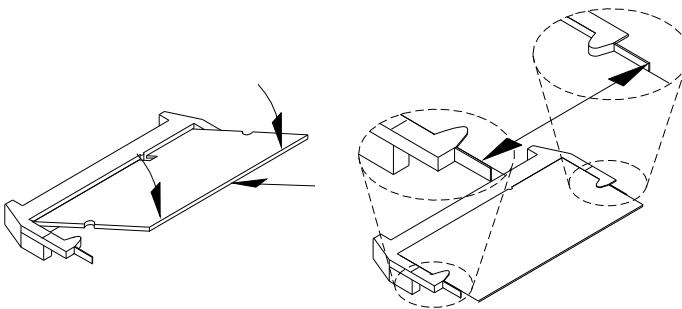

## Connector Pin Assignments

1. X1 (PCI-Bus, USB, Sound)
  2. X2 (ISA-Bus)
  3. X3 (VGA, LCD, Video, COM, COM2, LPT/Floppy, IrDA, Mouse, Keyboard, LCD)
  4. X4 (IDE 1, IDE 2, Ethernet, Misc)
- FAN1: System Fan Power Connector
5. CN1, CN2: Serial ATA Connectors
  6. FAN1: System Fan Power Connector

### 1. X1 (PCI-Bus, USB, Sound)

Pin	Signal	Pin	Signal	Pin	Signal	Pin	Signal
1	GND	2	GND	51	VCC	52	VCC
3	PCICLK3	4	PCICLK4	53	PAR	54	SERRJ
5	GND	6	GND	55	GPERRJ	56	N C
7	PCICLK1	8	PCICLK2	57	PMEJ	58	USB20
9	REQJ3	10	GNTJ3	59	LOCKJ	60	DEVSELJ
11	GNTJ2	12	3V	61	TRDYJ	62	USB30
13	REQJ2	14	GNTJ1	63	IRDYJ	64	STOPJ
15	REQJ 1	16	3V	65	FRAMEJ	66	USB21
17	GNTJ0	18	NC	67	GND	68	GND
19	VCC	20	VCC	69	AD16	70	CBEJ2
21	SERIRQ	22	REQJ0	71	AD17	72	USB31
23	AD0	24	3V	73	AD19	74	AD18
25	AD1	26	AD2	75	AD20	76	USB00
27	AD4	28	AD3	77	AD22	78	AD21
29	AD6	30	AD5	79	AD23	80	USB10
31	CBFJ0	32	AD7	81	AD24	82	CBEJ3
33	AD8	34	AD9	83	VCC	84	VCC
35	GND	36	GND	85	AD25	86	AD26
37	AD10	38	AUXAL	87	AD28	88	USB01
39	AD11	40	MIC	89	AD27	90	AD29
41	AD12	42	AUXAR	91	AD30	92	USB11
43	AD13	44	ASVCC	93	PCIRSTJ	94	AD31
45	AD14	46	SNDL	95	IRQY	96	IRQZ
47	AD15	48	ASGND	97	IRQW	98	IRQX
49	CBEJ1	50	SNDR	99	GND	100	GND

**2. X2 (ISA-Bus)**

Pin	Signal	Pin	Signal	Pin	Signal	Pin	Signal
1	GND	2	GND	51	VCC	52	VCC
3	SD14	4	SD15	53	SA6	54	IRQ5
5	SD13	6	MASTERJ	55	SA7	56	IR06
7	SD12	8	DREQ7	57	SA8	58	IRQ7
9	SD11	10	DACKJ7	59	SA9	60	SYSCLK
11	SD10	12	DREQ6	61	SA10	62	REFSHJ
13	SD9	14	DACKJ6	63	SA11	64	DREQ1
15	SD8	16	DREQ5	65	SA12	66	DACKJ 1
17	MEMWJ	18	DACKJ5	67	GND	68	GND
19	MEMRJ	20	DREQ0	69	SA13	70	DREQ3
21	LA17	22	DACKJ0	71	SA14	72	DACKJ3
23	LA18	24	IRQ14	73	SA15	74	IORJ
25	LA19	26	IR015	75	SA16	76	IOWJ
27	LA20	28	IRQ12	77	SA18	78	SA17
29	LA21	30	IRQ11	79	SA19	80	SMEMRJ
31	LA22	32	IRQ10	81	IOCHRDY	82	AEN
33	LA23	34	I016J	83	VCC	84	VCC
35	GND	36	GND	85	SD0	86	SMEMWJ
37	SBHEJ	38	M16J	87	SD2	88	SD1
39	SA0	40	OSC	89	SD3	90	NOWSJ
41	SA1	42	BALE	91	DREQ2	92	SD4
43	SA2	44	TC	93	SD5	94	IRQ9
45	SA3	46	DACKJ2	95	SD6	96	SD7
47	SA4	48	IR03	97	IOCHKJ	98	RSTDRV
49	SA5	50	IRQ4	99	GND	100	GND

### 3. X3 (VGA, LCD, Video, COM, COM2, LPT/Floppy, IrDA, Mouse, Keyboard, LCD)

Pin	Signal	Pin	Signal	Pin	Signal	Pin	Signal
1	GND	2	GND	51	NC	52	NC
3	R	4	B	53	VCC	54	GND
5	HSY	6	G	55	/STB	56	/AFD
7	VSY	8	DDCK	57	NC	58	PD7
9	NC	10	DDDA	59	IRRX	60	/ERR
11	LCD DO16	12	NC	61	IRTX	62	PD7
13	LCD DO17	14	NC	63	RXD2	64	/INIT
15	GND	16	GND	65	GND	66	GND
17	LCD DO13	18	LCD DO15	67	RTS2J	68	PD5
19	LCD DO12	20	LCD DO14	69	DTR2J	70	/SLIN
21	GND	22	GND	71	DCD2J	72	PD4
23	NC	24	LCD DO11	73	DSR2J	74	PD3
25	NC	26	LCD DO10	75	CTS2J	76	PD2
27	GND	28	GND	77	TXD2J	78	PD1
29	LCD DO4	30	LCD DO7	79	RI2J	80	PD0
31	LCD DO5	32	LCD DO6	81	VCC	82	VCC
33	GND	34	GND	83	RXD1	84	/ACK
35	LCD DO1	36	LCD DO3	85	RTS1J	86	/BUSY
37	LCD DO0	38	LCD DO2	87	DTR1J	88	PE
39	VCC	40	VCC	89	DCD1J	90	/SLCT
41	NC	42	LTGIO0	91	DSR1J	92	MSCLK
43	NC	44	BLON#	93	CTS1J	94	MSDAT
45	BIASON	46	DIGON	95	TXD1	96	KBCLK
47	COMP	48	Y	97	RI1J	98	KBDAT
49	NC	50	C	99	GND	100	GND

#### 4. X4 (IDE 1, IDE 2, Ethernet, Misc)

Pin	Signal	Pin	Signal	Pin	Signal	Pin	Signal
1	GND	2	GND	51	SIDE IOWJ	52	PIDE_IORJ
3	5V SB	4	PWGIN	53	SIDE DRQ	54	PIDE IOWJ
5	PS ON	6	SPEAKER	55	SIDE D15	56	PIDE DRQ
7	NC	8	BATT	57	SIDE DO	58	PIDE D15
9	RSMRST#	10	LILED	59	SIDE D14	60	PIDE DO
11	NC	12	ACTLED	61	SIDE D1	62	PIDE D14
13	NC	14	SPEEDLED	63	SIDE D13	64	PIDE D1
15	NC	16	NC	65	GND	66	GND
17	VCC	18	VCC	67	SIDE D2	68	PIDE D13
19	OVC RJ	20	NC	69	SIDE D12	70	PIDE D2
21	EXTSMI	22	NC	71	SIDE D3	72	PIDE D12
23	SMBCLK	24	SMBDATA	73	SIDE-D 1	74	PIDE D3
25	SIDE_CS3J	26	NC	75	SIDE D4	76	PIDE D11
27	SIDE CS1J	28	NC	77	SIDE D10	78	PIDE D4
29	SIDE A2	30	PIDE_CS3J	79	SIDE D5	80	PIDE D10
31	SIDE AO	32	PIDE CS1J	81	VCC	82	VCC
33	GND	34	GND	83	SIDE-D9	84	PIDE D5
35	SIDE_DIAG	36	PIDE_A2	85	SIDE D6	86	PIDE D9
37	SIDE AI	38	PIDE_A0	87	SIDE-D8	88	PIDE D6
39	SIDE INTRO	40	PIDE A1	89	NC	90	CBLID_P
41	BATLOW	42	NC	91	RXD-	92	PIDE D8
43	SIDE_AKJ	44	PIDE INTRO	93	RXD+	94	SIDE D7
45	SIDE_RDY	46	PIDE_AKJ	95	TXD-	96	PIDE D7
47	SIDE_IORJ	48	PIDE RDY	97	TXD+	98	HDRSTJ
49	VCC	50	VCC	99	GND	100	GND

#### 5. CN1, CN2: Serial ATA Connectors.

Located just beside the SODIMM memory socket are two serial ATA connectors.

#### 6. FAN1: System Fan Power Connector

FAN1 is a 3-pin header for system fans.

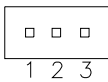

Pin #	Signal Name
1	Ground
2	+5V
3	Ground

---

## BIOS Setup

This chapter describes the different settings available in the Award BIOS that comes with the board. The topics covered in this chapter are as follows:

BIOS Introduction .....	14
BIOS Setup .....	14
Standard CMOS Setup .....	16
Advanced BIOS Features .....	19
Advanced Chipset Features .....	22
Integrated Peripherals .....	24
Power Management Setup .....	27
PNP/PCI Configurations .....	29
PC Health Status .....	30
Load Fail-Safe Defaults .....	31
Load Optimized Defaults .....	31
Set Supervisor/User Password .....	31
Save & Exit Setup .....	31
Exit Without Saving .....	31

## BIOS Introduction

The Award BIOS (Basic Input/Output System) installed in your computer system's ROM supports Intel processors. The BIOS provides critical low-level support for a standard device such as disk drives, serial ports and parallel ports. It also adds virus and password protection as well as special support for detailed fine-tuning of the chipset controlling the entire system.

## BIOS Setup

The Award BIOS provides a Setup utility program for specifying the system configurations and settings. The BIOS ROM of the system stores the Setup utility. When you turn on the computer, the Award BIOS is immediately activated. Pressing the <Del> key immediately allows you to enter the Setup utility. If you are a little bit late pressing the <Del> key, POST (Power On Self Test) will continue with its test routines, thus preventing you from invoking the Setup. If you still wish to enter Setup, restart the system by pressing the "Reset" button or simultaneously pressing the <Ctrl>, <Alt> and <Delete> keys. You can also restart by turning the system Off and back On again. The following message will appear on the screen:

```
Press <DEL> to Enter Setup
```

In general, you press the arrow keys to highlight items, <Enter> to select, the <PgUp> and <PgDn> keys to change entries, <F1> for help and <Esc> to quit.

When you enter the Setup utility, the Main Menu screen will appear on the screen. The Main Menu allows you to select from various setup functions and exit choices.

## Phoenix - AwardBIOS CMOS Setup Utility

Standard CMOS Features	Frequency/Voltage Control
Advanced BIOS Features	Load Fail-Safe Defaults
Advanced Chipset Features	Load Optimized Defaults
Integrated Peripherals	Set Supervisor Password
Power Management Setup	Set User Password
PnP/PCI Configurations	Save & Exit Setup
PC Health Status	Exit Without Saving
ESC : Quit	↑ ↓ → ← : Select Item
F10 : Save & Exit Setup	
Time, Date, Hard Disk Type...	

The section below the setup items of the Main Menu displays the control keys for this menu. At the bottom of the Main Menu just below the control keys section, there is another section, which displays information on the currently highlighted item in the list.

**Note:** *If the system cannot boot after making and saving system changes with Setup, the Award BIOS supports an override to the CMOS settings that resets your system to its default.*

**Warning:** *It is strongly recommended that you avoid making any changes to the chipset defaults. These defaults have been carefully chosen by both Award and your system manufacturer to provide the absolute maximum performance and reliability. Changing the defaults could cause the system to become unstable and crash in some cases.*

## Standard CMOS Setup

“Standard CMOS Setup” choice allows you to record some basic hardware configurations in your computer system and set the system clock and error handling. If the board is already installed in a working system, you will not need to select this option. You will need to run the Standard CMOS option, however, if you change your system hardware configurations, the onboard battery fails, or the configuration stored in the CMOS memory was lost or damaged.

Phoenix - AwardBIOS CMOS Setup Utility  
Standard CMOS Features

Date (mm:dd:yy)	Wed, Apr 28, 2004	Item Help
Time (hh:mm:ss)	00 : 00 : 00	Menu Level >
IDE Channel 0 Master	None	Change the day, month, Year and century
IDE Channel 0 Slave	None	
IDE Channel 1 Master	None	
IDE Channel 1 Slave	None	
Video	EGA/VGA	
Halt On	All Errors	
Base Memory	640K	
Extended Memory	129024K	
Total Memory	130048K	

At the bottom of the menu are the control keys for use on this menu. If you need any help in each item field, you can press the <F1> key. It will display the relevant information to help you. The memory display at the lower right-hand side of the menu is read-only. It will adjust automatically according to the memory changed. The following describes each item of this menu.

### Date

The date format is:

**Day :** Sun to Sat  
**Month :** 1 to 12  
**Date :** 1 to 31  
**Year :** 1999 to 2099

To set the date, highlight the “Date” field and use the PageUp/PageDown or +/- keys to set the current time.

### Time

The time format is: **Hour : 00 to 23**  
**Minute : 00 to 59**  
**Second : 00 to 59**

To set the time, highlight the “Time” field and use the <PgUp>/<PgDn> or +/- keys to set the current time.

### IDE Channel Master/Slave

The onboard PCI IDE connector provides Primary and Secondary channels for connecting up to two IDE hard disks or other IDE devices.

Press <Enter> to configure the hard disk. The selections include Auto, Manual, and None. Select ‘Manual’ to define the drive information manually. You will be asked to enter the following items.

**CYLS :** Number of cylinders  
**HEAD :** Number of read/write heads  
**PRECOMP :** Write precompensation  
**LANDING ZONE :** Landing zone  
**SECTOR :** Number of sectors

The Access Mode selections are as follows:

CHS (HD < 528MB)  
LBA (HD > 528MB and supports  
Logical Block Addressing)  
Large (for MS-DOS only)  
Auto

**Remarks:** The main board supports two serial ATA ports and are represented in this setting as IDE Channel 0.

### Video

This field selects the type of video display card installed in your system.

You can choose the following video display cards:

EGA/VGA	For EGA, VGA, SEGA, SVGA or PGA monitor adapters. (default)
CGA 40	Power up in 40 column mode.
CGA 80	Power up in 80 column mode.
MONO	For Hercules or MDA adapters.

### Halt On

This field determines whether or not the system will halt if an error is detected during power up.

No errors	The system boot will not be halted for any error that may be detected.
All errors	Whenever the BIOS detects a non-fatal error, the system will stop and you will be prompted.
All, But Keyboard	The system boot will not be halted for a keyboard error; it will stop for all other errors
All, But Diskette	The system boot will not be halted for a disk error; it will stop for all other errors.
All, But Disk/Key	The system boot will not be halted for a keyboard or disk error; it will stop for all others.

## Advanced BIOS Features

This section allows you to configure and improve your system and allows you to set up some system features according to your preference.

Phoenix - AwardBIOS CMOS Setup Utility  
Advanced BIOS Features

		ITEM HELP
CPU Feature	Press Enter	
Hard Disk Boot Priority	Press Enter	
Virus Warning	Disabled	Menu Level >
CPU L1 and L2 Cache	Enabled	
CPU L3 Cache	Enabled	
Quick Power On Self Test	Enabled	
First Boot Device	Floppy	
Second Boot Device	Hard Disk	
Third Boot Device	CDROM	
Boot Other Device	Enabled	
Boot Up NumLock Status	On	
Gate A20 Option	Fast	
Typematic Rate Setting	Disabled	
Typematic Rate (Chars/Sec)	6	
Typematic Delay (Msec)	250	
Security Option	Setup	
APIC Mode	Enabled	
MPS Version Control for OS	1.4	
OS Select For DRAM>64MB	Non-OS2	
Small Logo (EPA) Show	Disabled	

### CPU Feature

Press Enter to configure the settings relevant to CPU Feature.

### Hard Disk Boot Priority

With the field, there is the option to choose, aside from the hard disks connected, "Bootable add-in Cards" which refers to other external devices.

### Virus Warning

If this option is enabled, an alarm message will be displayed when trying to write on the boot sector or on the partition table on the disk, which is typical of the virus.

### CPU L1 / L2 / L3 Cache

Cache memory is additional memory that is faster than conventional DRAM (system memory). CPUs from 486-type on up contain internal cache memory, and most, but not all, modern PCs have additional (external) cache memory. When the CPU requests data, the system transfers the requested data from the main DRAM into cache memory, for even faster access by the CPU. These allow you to enable (speed up memory access) or disable the cache function.

### **Quick Power On Self Test**

When enabled, this field speeds up the Power On Self Test (POST) after the system is turned on. If it is set to *Enabled*, BIOS will skip some items.

### **First/Second/Third Boot Device**

These fields determine the drive that the system searches first for an operating system. The options available include *Floppy*, *LS120*, *Hard Disk*, *CDROM*, *ZIP100*, *USB-Floppy*, *USB-ZIP*, *USB-CDROM*, *LAN* and *Disable*.

### **Boot Other Device**

These fields allow the system to search for an OS from other devices other than the ones selected in the First/Second/Third Boot Device.

### **Boot Up NumLock Status**

This allows you to activate the NumLock function after you power up the system.

### **Gate A20 Option**

This field allows you to select how Gate A20 is worked. Gate A20 is a device used to address memory above 1 MB.

### **Typematic Rate Setting**

When disabled, continually holding down a key on your keyboard will generate only one instance. When enabled, you can set the two typematic controls listed next. By default, this field is set to *Disabled*.

### **Typematic Rate (Chars/Sec)**

When the typematic rate is enabled, the system registers repeated keystrokes speeds. Settings are from 6 to 30 characters per second.

### **Typematic Delay (Msec)**

When the typematic rate is enabled, this item allows you to set the time interval for displaying the first and second characters. By default, this item is set to *250msec*.

### **Security Option**

This field allows you to limit access to the System and Setup. The default value is *Setup*. When you select *System*, the system prompts for the User Password every time you boot up. When you select *Setup*, the system always boots up and prompts for the Supervisor Password only when the Setup utility is called up.

### **APIC Mode**

APIC stands for Advanced Programmable Interrupt Controller. The default setting is *Enabled*.

### **MPS Version Control for OS**

This option specifies the MPS (Multiprocessor Specification) version for your operating system. MPS version 1.4 added extended configuration tables to improve support for multiple PCI bus configurations and improve future expandability. The default setting is *1.4*.

### **OS Select for DRAM > 64MB**

This option allows the system to access greater than 64MB of DRAM memory when used with OS/2 that depends on certain BIOS calls to access memory. The default setting is *Non-OS/2*.

### **Small Logo (EPA) Show**

The EPA logo appears at the right side of the monitor screen when the system is boot up. The default setting is *Disabled*.

## Advanced Chipset Features

This Setup menu controls the configuration of the chipset.

Phoenix - AwardBIOS CMOS Setup Utility  
Advanced Chipset Features

		ITEM HELP
DRAM Timing Selectable	By SPD	Menu Level >
CAS Latency Time	Auto	
DRAM RAS# to CAS# Delay	Auto	
DRAM RAS# Precharge	Auto	
Precharge delay (tRAS)	Auto	
System Memory Frequency	Auto	
System BIOS Cacheable	Enabled	
Video BIOS Cacheable	Disabled	
Memory Hole at 15M-16M	Disabled	
PCI Express Root Port Func	Press Enter	
** On-Chip VGA Setting **		
PEG/On Chip VGA Control	Auto	
On-Chip Frame Buffer Size	8MB	
DVMT Mode	DVMT	
DVMT/FIXED memory Size	128MB	
Boot Display	CRT+LVDS	
Panel Scaling	Auto	
Panel Number	1024x768 18 bit SC	

### DRAM Timing Selectable

This option refers to the method by which the DRAM timing is selected. The default is *By SPD*.

### CAS Latency Time

You can configure CAS latency time in HCLKs as 2 or 2.5 or 3. The system board designer should set the values in this field, depending on the DRAM installed. Do not change the values in this field unless you change specifications of the installed DRAM or the installed CPU.

### DRAM RAS# to CAS# Delay

This option allows you to insert a delay between the RAS (Row Address Strobe) and CAS (Column Address Strobe) signals. This delay occurs when the SDRAM is written to, read from or refreshed. Reducing the delay improves the performance of the SDRAM.

### DRAM RAS# Precharge

This option sets the number of cycles required for the RAS to accumulate its charge before the SDRAM refreshes. The default setting for the Active to Precharge Delay is *Auto*.

### Precharge Delay (tRAS)

The default setting for the Precharge Delay is *Auto*.

## System Memory Frequency

The default setting is *Auto*.

## System BIOS Cacheable

The setting of *Enabled* allows caching of the system BIOS ROM at F000h-FFFFh, resulting in better system performance. However, if any program writes to this memory area, a system error may result.

## Video BIOS Cacheable

The Setting *Enabled* allows caching of the video BIOS ROM at C0000h-F7FFFh, resulting in better video performance. However, if any program writes to this memory area, a system error may result.

## Memory Hole At 15M-16M

In order to improve performance, certain space in memory can be reserved for ISA cards. This memory must be mapped into the memory space below 16 MB. The choices are *Enabled* and *Disabled*.

## On-Chip VGA Setting

The fields under the On-Chip VGA Setting and their default settings are:

PEG/On Chip VGA Control: Auto  
 On-Chip Frame Buffer Size: 8MB  
 DVMT Mode: DVTM  
 DVMT/Fixed Memory Size: 128MB  
 Boot Display: CRT+LVDS  
 Panel Scaling: Auto  
 Panel Number: 1024x768 18 bit SC

The options for the Boot Display field are CRT+LVDS, CRT, and LVDS.

## Panel Scaling

The default setting is *Auto*. The options available include *On* and *Off*.

## Panel Number

These fields allow you to select the LCD Panel type. The default values for these ports are:

640x480	18bit SC
800x480	18bit SC
800x600	18bit SC
1024x768	18bit SC
1280x1024	18bit DC
1280x768	18bit SC
1400x1050	18bit DC
1600x1200	18bit DC

### Integrated Peripherals

This section sets configurations for your hard disk and other integrated peripherals. The first screen shows three main items for user to select. Once an item selected, a submenu appears. Details follow.

Phoenix - AwardBIOS CMOS Setup Utility  
Integrated Peripherals

OnChip IDE Device	Press Enter	ITEM HELP
Onboard Device	Press Enter	Menu Level >
SuperIO Device	Press Enter	

Phoenix - AwardBIOS CMOS Setup Utility  
**OnChip IDE Device**

IDE HDD Block Mode	Enabled	ITEM HELP
IDE DMA Transfer Access	Enabled	Menu Level >
On-chip Primary PCI IDE	Enabled	
IDE Primary Master PIO	Auto	
IDE Primary Slave PIO	Auto	
IDE Primary Master UDMA	Auto	
IDE Primary Slave UDMA	Auto	
On-Chip Secondary PCI IDE	Enabled	
IDE Secondary Master PIO	Auto	
IDE Secondary Slave PIO	Auto	
IDE Secondary Master UDMA	Auto	
IDE Secondary Slave UDMA	Auto	
*** On-Chip Serial ATA Setting ***		
On-Chip Serial ATA	Auto	
PATA IDE Speed Settings	Disabled	
PATA IDE Mode	Secondary	
SATA port	P0, P2 is Primary	

Phoenix - AwardBIOS CMOS Setup Utility  
**Onboard Device**

USB Controller	Enabled	ITEM HELP
USB 2.0 Controller	Enabled	Menu Level >
USB Keyboard Support	Disabled	
AC97 Audio Select	Auto	

## Phoenix - AwardBIOS CMOS Setup Utility

**SuperIO Device**

		ITEM HELP
Onboard Serial Port 1	3F8/IRQ4	
Onboard Serial Port 2	2F8/IRQ3	
UART Mode Select	Normal	
RxD , TxD Active	Hi, Lo	
IR Transmission Delay	Disabled	Menu Level >
UR2 Duplex Mode	Half	
Use IR Pins	IR-Rx2Tx2	
Parallel Port Mode	SPP	
EPP Mode Select	EPP1.7	
ECP Mode Use DMA	3	

**IDE HDD Block Mode**

This field allows your hard disk controller to use the fast block mode to transfer data to and from your hard disk drive.

**IDE DMA Transfer Access**

This field has a default setting of *Enabled*.

**On-chip Primary PCI IDE Enabled**

This field, by default, is *Enabled*.

**OnChip Primary/Secondary PCI IDE**

The integrated peripheral controller contains an IDE interface with support for two IDE channels. Select *Enabled* to activate each channel separately.

**IDE Primary/Secondary Master/Slave PIO**

These fields allow your system hard disk controller to work faster. Rather than have the BIOS issue a series of commands that transfer to or from the disk drive, PIO (Programmed Input/Output) allows the BIOS to communicate with the controller and CPU directly.

The system supports five modes, numbered from 0 (default) to 4, which primarily differ in timing. When Auto is selected, the BIOS will select the best available mode.

**IDE Primary/Secondary Master/Slave UDMA**

These fields allow your system to improve disk I/O throughput to 33Mb/sec with the Ultra DMA/33 feature. The options are *Auto* and *Disabled*.

### On-Chip Serial ATA Setting

The fields under the SATA setting include On-Chip Serial ATA (Auto), PATA IDE Mode (Secondary), PATA IDE Speed Settings, and SATA Port (PO, P2 is Primary).

### USB Controller

The options for this field are *Enabled* and *Disabled*. By default, this field is set to *Enabled*.

### USB 2.0 Controller

The options for this field are *Enabled* and *Disabled*. By default, this field is set to *Enabled*. In order to use USB 2.0, necessary OS drivers must be installed first. *Please update your system to Windows 2000 SP4 or Windows XP SP2.*

### USB Keyboard Support

The options for this field are *Enabled* and *Disabled*. By default, this field is set to *Disabled*.

### AC97 Audio Select

This field, by default, is set to *Auto*.

### Onboard Serial/Parallel Port

These fields allow you to select the onboard serial and parallel ports and their addresses. The default values for these ports are:

Serial Port 1	3F8/IRQ4
Serial Port 2	2F8/IRQ3
Parallel Port	378H/IRQ7

### UART Mode Select

This field determines the UART 2 mode in your computer. The default value is *Normal*. Other options include *IrDA* and *ASKIR*.

### Parallel Port Mode

This field allows you to determine parallel port mode function.

SPP	Standard Printer Port
EPP	Enhanced Parallel Port
ECP	Extended Capabilities Port
ECP+EPP	Combination of ECP and EPP capabilities
Normal	Normal function

## Power Management Setup

Phoenix - AwardBIOS CMOS Setup Utility  
Power Management Setup

		ITEM HELP
ACPI Function	Disabled	
ACPI Suspend	S3 (STR)	
Power Management	User Define	Menu Level >
Video Off Method	V/H SYNC + Blank	
Video Off In Suspend	Yes	
Suspend Type	Stop Grant	
Suspend Mode	Disabled	
HDD Power Down	Disabled	
CPU THRM-Throttling	50%	
Resume by Alarm	Disabled	
Date (of Month) Alarm	0	
Time (hh:mm:ss) Alarm	0 : 0 : 0	
** Reload Global Timer Events **		
Primary IDE 0	Disabled	
Primary IDE 1	Disabled	
Secondary IDE 0	Disabled	
Secondary IDE 1	Disabled	
FDD, COM, LPT Port	Disabled	
PCI PIRQ[A-D] #	Disabled	

### ACPI Function

Enable this function to support ACPI (Advance Configuration and Power Interface).

### ACPI Suspend

The default setting of the ACPI Suspend mode is **S3(STR)**.

### Power Management

This field allows you to select the type of power saving management modes. There are four selections for Power Management.

Min. Power Saving	Minimum power management
Max. Power Saving	Maximum power management.
User Define	Each of the ranges is from 1 min. to 1hr. Except for HDD Power Down which ranges from 1 min. to 15 min.

### Video Off Method

This field defines the Video Off features. There are three options.

V/H SYNC + Blank	Default setting, blank the screen and turn off vertical and horizontal scanning.
DPMS	Allows BIOS to control the video display.
Blank Screen	Writes blanks to the video buffer.

### **Video Off In Suspend**

When enabled, the video is off in suspend mode. The default setting is *Yes*.

### **Suspend Type**

The default setting for the Suspend Type field is *Stop Grant*.

### **Suspend Mode**

When enabled, and after the set time of system inactivity, all devices except the CPU will be shut off.

### **HDD Power Down**

When enabled, and after the set time of system inactivity, the hard disk drive will be powered down while all other devices remain active.

### **CPU THRM-Throttling**

When the system enters Doze mode, the CPU clock runs only part of the time. You may select the percent of time that the clock runs.

### **Resume by Alarm**

This field enables or disables the resumption of the system operation. When enabled, the user is allowed to set the *Date* and *Time*.

### **Reload Global Timer Events**

The HDD, COM, LPT Ports, and PCI PIRQ are I/O events that can prevent the system from entering a power saving mode or can awaken the system from such a mode. When an I/O device wants to gain the attention of the operating system, it signals this by causing an IRQ to occur. When the operating system is ready to respond to the request, it interrupts itself and performs the service.

## PNP/PCI Configurations

This option configures the PCI bus system. All PCI bus systems on the system use INT#, thus all installed PCI cards must be set to this value.

Phoenix - AwardBIOS CMOS Setup Utility  
PnP/PCI Configurations

Init Display First	PCI Slot	ITEM HELP
Reset Configuration Data	Disabled	
Resources Controlled By	Auto (ESCD)	Menu Level
IRQ Resources	Press Enter	Select Yes if you are using a Plug and Play capable operating system Select No if you need the BIOS to configure non-boot devices
PCI/VGA Palette Snoop	Disabled	
INT Pin 1 Assignment	Auto	
INT Pin 2 Assignment	Auto	
INT Pin 3 Assignment	Auto	
INT Pin 4 Assignment	Auto	
INT Pin 5 Assignment	Auto	
INT Pin 6 Assignment	Auto	
INT Pin 7 Assignment	Auto	
INT Pin 8 Assignment	Auto	
**PCI Express relative items**		
Maximum Payload Size	4096	

### Init Display First

The default setting is *PCI Card*.

### Reset Configuration Data

This field allows you to determine whether to reset the configuration data or not. The default value is *Disabled*.

### Resources Controlled by

This PnP BIOS can configure all of the boot and compatible devices with the use of a PnP operating system such as Windows 95.

### PCI/VGA Palette Snoop

Some non-standard VGA display cards may not show colors properly. This field allows you to set whether or not MPEG ISA/VESA VGA cards can work with PCI/VGA. When this field is enabled, a PCI/VGA can work with an MPEG ISA/VESA VGA card. When this field is disabled, a PCI/VGA cannot work with an MPEG ISA/VESA card.

### Maximum Payload Size

The default setting of the PCI Express Maximum Payload Size is 4096.

## PC Health Status

This section shows the parameters in determining the PC Health Status. These parameters include temperatures, fan speeds and voltages.

Phoenix - AwardBIOS CMOS Setup Utility  
PC Health Status

		ITEM HELP
Shutdown Temperature	Disabled	Menu Level >
CPU Warning Temperature	Disabled	
Current System Temp	45°C/113°F	
Current CPU Temp	45°C/113°F	
Vcore(V)	1.02 V	
1.8V	1.9V	
Vcc3	3.3V	
5V	4.96V	
3.3V	3.29V	
VBAT(V)	3.29V	
5VSB(V)	5.58V	
System FAN Speed	5400 RPM	
CPU FAN Speed	5400 RPM	

### CPU Warning Temperature

This field allows the user to set the temperature so that when the temperature is reached, the system sounds a warning. This function can help prevent damage to the system that is caused by overheating.

### Temperatures/Voltages

These fields are the parameters of the hardware monitoring function feature of the main board. The values are read-only values as monitored by the system and show the PC health status.

### Shutdown Temperature

This field allows the user to set the temperature by which the system automatically shuts down once the threshold temperature is reached. This function can help prevent damage to the system that is caused by overheating.

### **Load Fail-Safe Defaults**

This option allows you to load the troubleshooting default values permanently stored in the BIOS ROM. These default settings are non-optimal and disable all high-performance features.

### **Load Optimized Defaults**

This option allows you to load the default values to your system configuration. These default settings are optimal and enable all high performance features.

### **Set Supervisor Password**

These two options set the system password. Supervisor Password sets a password that will be used to protect the system and Setup utility. User Password sets a password that will be used exclusively on the system. To specify a password, highlight the type you want and press <Enter>. The Enter Password: message prompts on the screen. Type the password, up to eight characters in length, and press <Enter>. The system confirms your password by asking you to type it again. After setting a password, the screen automatically returns to the main screen.

To disable a password, just press the <Enter> key when you are prompted to enter the password. A message will confirm the password to be disabled. Once the password is disabled, the system will boot and you can enter Setup freely.

### **Save & Exit Setup**

This option allows you to determine whether or not to accept the modifications. If you type “Y”, you will quit the setup utility and save all changes into the CMOS memory. If you type “N”, you will return to Setup utility.

### **Exit Without Saving**

Select this option to exit the Setup utility without saving the changes you have made in this session. Typing “Y” will quit the Setup utility without saving the modifications. Typing “N” will return you to Setup utility.

This page is intentionally left blank.

## Drivers Installation

This section describes the installation procedures for software and drivers under the Windows 98SE, Windows ME, Windows 2000 and Windows XP. The software and drivers are included with the main board. If you find the items missing, please contact the vendor where you made the purchase. The contents of this section include the following:

Intel Chipset Software Installation Utility .....	34
VGA Drivers Installation .....	36
AC97 Codec Audio Driver Installation (IP100 only) .....	38
Intel PRO LAN Drivers Installation .....	40

### **IMPORTANT NOTE:**

After installing your Windows operating system (Windows 98SE/ME/2000/XP), you must install first the Intel Chipset Software Installation Utility before proceeding with the drivers installation.

## Intel Chipset Software Installation Utility

The Intel Chipset Drivers should be installed first before the software drivers to enable Plug & Play INF support for Intel chipset components. Follow the instructions below to complete the installation under Windows 2000/XP.

1. Insert the CD that comes with the board. Click **Intel Chipsets** and then **Intel(R) I945GM Chipset Drivers**.
2. Click **Intel(R) Chipset Software Installation Utility**.

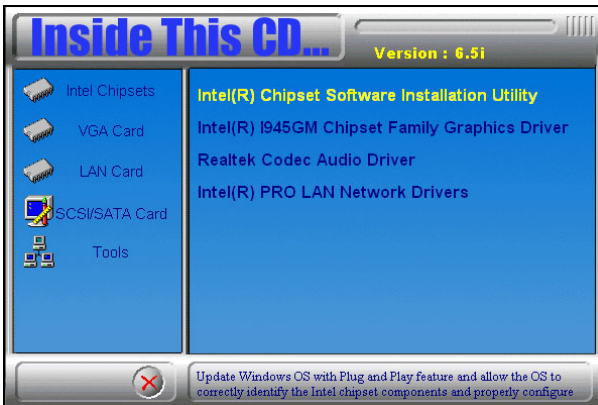

3. When the Welcome screen appears, click **Next** to continue.

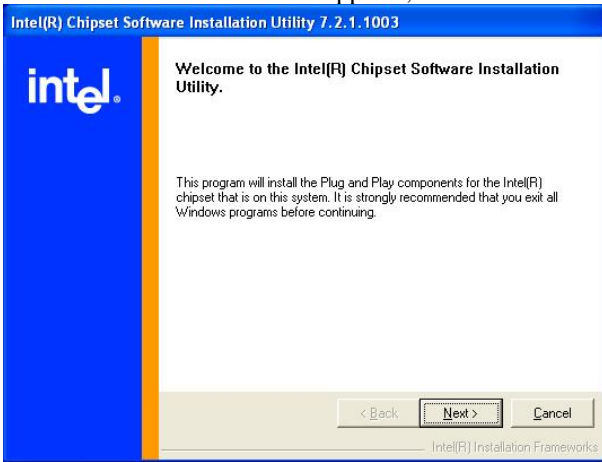

4. Click **Yes** to accept the software license agreement and proceed with the installation process.

5. On Readme Information screen, click **Next** to continue the installation.

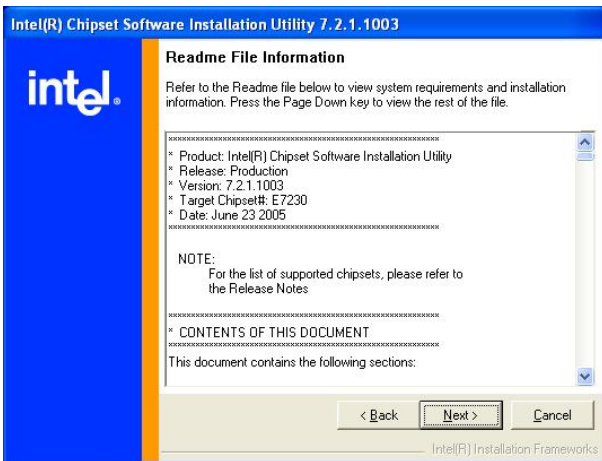

6. The Setup process is now complete. Click **Finish** to restart the computer and for changes to take effect. When the computer has restarted, the system will be able to find some devices. Restart your computer when prompted.

## VGA Drivers Installation

To install the VGA drivers, follow the steps below to proceed with the installation.

1. Insert the CD that comes with the board. Click *Intel Chipsets* and then *Intel(R) I945GM Chipset Drivers*.

2. Click *Intel(R) I945GM Chipset Family Graphics Driver*.

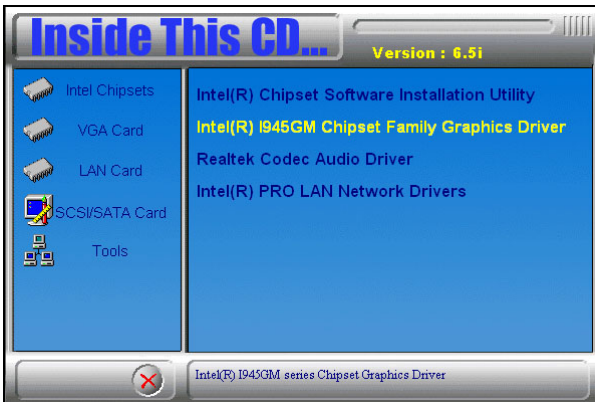

3. When the Welcome screen appears, click *Next* to continue.

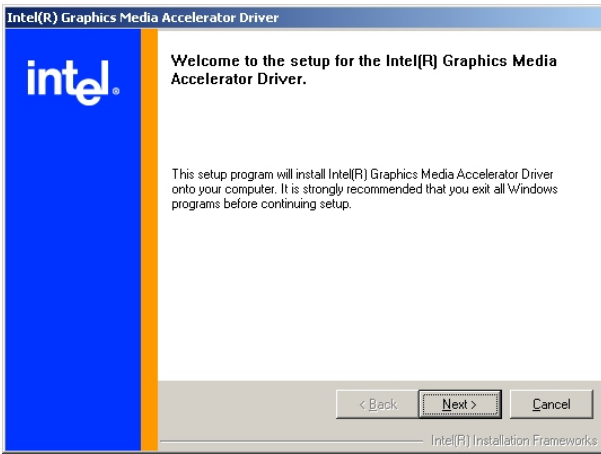

4. When the setup is complete, restart the computer as prompted and for changes to take effect.

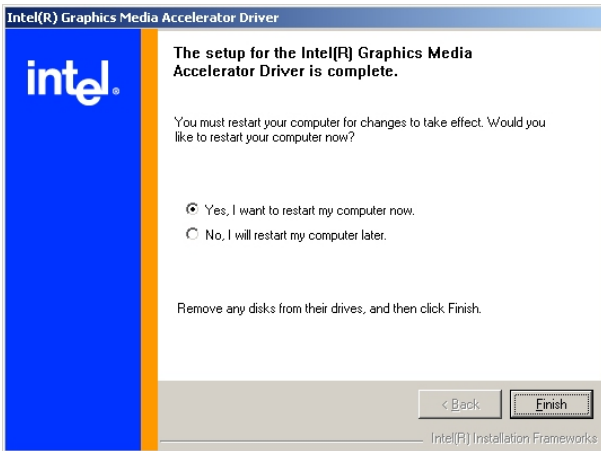

## AC97 Codec Audio Driver Installation (IP100 carrier board only)

Follow the steps below to install the Realtek AC97 Codec Audio Drivers.

1. Insert the CD that comes with the board. Click **Intel Chipsets** and then **Intel(R) I945GM Chipset Drivers**.

2. Click **Realtek Codec Audio Driver**.



3. When the screen below appears, click **Yes** to continue with the installation.



4. Click **Finish** to restart the computer and for changes to take effect. .

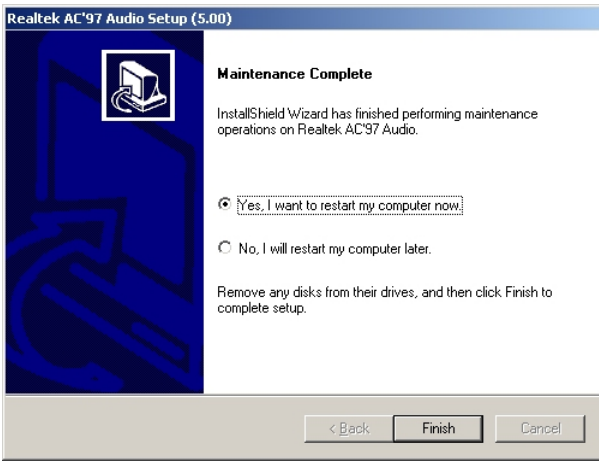

## Intel PRO LAN Drivers Installation

Follow the steps below to complete the installation of the Intel PRO LAN drivers.

1. Insert the CD that comes with the board. Click **Intel Chipsets** and then **Intel(R) I945GM Chipset Drivers**. Then, click **Intel(R) PRO LAN Network Drivers**.

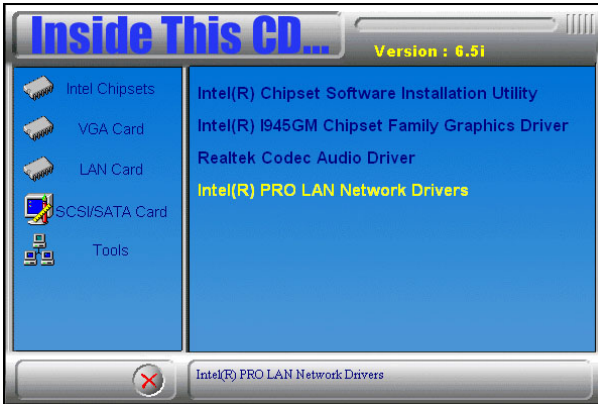

2. Click **Install Base Software** to continue.



3. When prompted, please to restart the computer for new settings to take effect.